

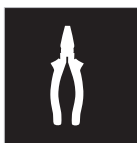

The MATADOR.

Premium hand tools and more since 1900.

Be a MATADOR.





Dear friends of
MATADOR,

finally we got it - our new M102.

On 335 pages we present our „world of hand tools“ with many pictures and descriptions, technical details and practical background information.

Starting 120 years ago on two water-powered forging hammers MATADOR today is one of the leading manufacturers of high quality tightening tools „around the screw“.

Although meanwhile more than 4.500 different tools belong to the MATADOR range, it is not our objective to provide you also the fifth version of a standard tool. We at MATADOR keep an eye on the essentials and with our clear focus on quality the professional user will find only tools one really needs and that convince through their quality.

People in more than 70 countries worldwide work with MATADOR.

True to our motto:

Be a MATADOR.

With best wishes

Peter Kissling

The new MATADOR article code:

After 113 years we decided to do something different: We have restructured our article codes in order to give you a better orientation: 8 digits and if possible a hint for the particular size.

For example:

Double Open Ended Spanners, SW 6 x 7 mm

0100 0607

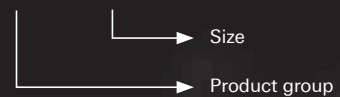

The first 4 digits show the product group, the last 4 digits illustrate the size of a tool (in most cases).



Content.

Introduction	3 - 9
1. Spanners and Wrenches	10 - 39
2. Ratchets and Sockets	40 - 85
3. Torque Control	86 - 107
4. Pneumatic Tools	108 - 137
5. Pliers	138 - 151
6. Key Wrenches / Screwdrivers / Bits	152 - 179
7. Miscellaneous Tools	180 - 227
8. Automotive Tools	228 - 247
9. VDE-Tools	248 - 259
10. Trolleys / Modules	260 - 309
11. Tool Cases / Tool Assortments	310 - 331
12. Technical Tables / Index	332 - 335



Since 1900.

Premium hand tools for professional users. All around the screw.





First team come together in 1906.

MATADOR is one of the **pioneers in the tool industry**. Since 1900 we have been producing **quality hand tools „around the screw“**. Still located in Remscheid - the German centre of the premium tool manufacturers - MATADOR belongs today to the leading German manufacturers of tightening tools.

For over 120 years MATADOR has been a fully privately owned and owner-managed **family enterprise** which is now in its fourth generation. Reliability, a longterm perspective and sustainable business operations form part of our core beliefs and values.

In 1900 Mr Heinrich Kissling, the founder of MATADOR, started on two **water-powered forging hammers** with the production of hand tools. In the following years he filed **many patents** for all kind of hand tools. Considering „MATADOR“ - the Spanish name for the principal bull-fighter - to be an **ideal synonym for strength and energy** he registered the brand name „MATADOR“ at the Commercial Register in 1919: „Wrenches and sockets in the very best quality and workmanship“.

100 years later and with a comprehensive product range of **more than 4,500 catalogue articles** MATADOR is still focussing on tightening tools

around the screw. The hexagon nut held by a stylized wrench as well as the word mark „MATADOR Schraubwerkzeuge“ symbolize the company's origin and its core competence.

As an accredited first tier supplier of **all major OEMs** and with professional customers in more than **70 countries** MATADOR tools are much appreciated by people who are the MATADORS in their field.

Without exaggeration we can say that nearly every professional workshop worldwide is equipped with at least one MATADOR tool.



For everyday heroes.

Be a MATADOR.

MATADOR is **not mainstream**. We stand for upmarket premium tools. Reliable, design-focused, efficient. Intelligent tightening tools made for decision makers, fighters and **everyday heroes**. For real MATADORS.

For people who know and express what they want. People **who are inside the arena**, not in the stands. Who know **the difference between tools and toys**. Who do not seek excuses and are true to themselves. Past and present. For down-to-earth, straightforward and assertive individuals with life experience and stories to tell. Who overcome adversity, manage a healthy work-life balance and **believe in themselves**. Who appreciate the exceptional and do not hesitate to show that.

Welcome to the arena.

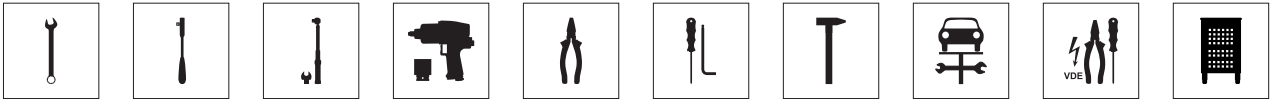

MATADOR at a glance.

What you should know about MATADOR.



**Since
1900.**

**Family-
owned.**

**All around
the screw.**

**First lever
ratchet in
1919.**

**>4,500
premium
tools.**

**Focussed on
industry and
automotive.**

**>1,000 B2B
customers.**

**OEM
accredited.**

**>70
countries.**

Spanners and Wrenches.

Be a MATADOR.



Content Spanners and wrenches.

Page Article group



The Classics.

14	Double Open Ended Spanners
15	Double Open Ended Spanners Sets
16	Combination Spanners, angled
17	Combination Spanners Sets
18	Combination Spanners, offset (MM)
19	Combination Spanners, offset (AF)
19	Combination Spanners Sets
20	Double Ended Ring Spanners
21	Double Ended Ring Spanners Sets



The Troubleshooter.

22	Magnetic Spanners Set
22	Adjustable Single Ended Spanner
23	Adjustable Spanners



The Innovative.

24	Combination Ratchet Spanners, straight
25	Combination Ratchet Spanners Sets
26	Combination Ratchet Spanners, angled
26	Adapters for Ratchet Spanners
27	4in1 Ratchet Spanner



The Sturdy ones.

28	Slogging Open Ended Spanners (MM)
30	Slogging Ring Ended Spanners (MM)
31	Slogging Ring Ended Spanners (AF)
32	Heavy Duty Ring Spanners (MM)
33	Extension Pipes for Heavy Duty

Page Article group



Ring Spanners

The Specials.

34	Half Moon Ring Spanners
35	Double Ended Ring Spanners, straight
35	Double Ended Ring Spanners, TORX [®]
36	Flare Nut Ring Spanners, open
36	Flare Nut Ring Spanners, open
37	Tommy Bar
37	Tubular Box Spanners
38	Hexagon Nut Drivers
38	Hexagon Nut Drivers, flexible
39	Nut Drivers with T-Handle
39	Wheel Nut Wrenches
39	Tommy Bar



MATADOR Spanners. For manual tightening.

Nothing gets done without the good old spanner.



More torque.

To make an accurate and perfectly finished spanner out of a piece of flat steel more than 10 working steps are necessary.

MATADOR processes only high grade, quality-tested Chrome Vanadium steel (31CrV3) that is automatically heated exactly to the right forging temperature.

A precise mechanical processing on state-of-the-art production machines as well as a fully automatic, material-protecting hardening procedure are the basis of the long-lasting quality of our spanners.

Tight spanners tolerances guarantee that the maximum torque can really be applied. And not only the MATADOR Smart Drive profile on the ring side but also precisely grounded heads on the open ended side do not only protect the screw but also ensure that the spanner fits perfectly to the screw.

MATADOR. More torque.
More performance.

Millionfold tried and tested quality.

For more than 110 years MATADOR has been producing several different types of spanners for professional users in industry and craft.

Tightening tools represent our core competence. For screw sizes from 4 up to 230 mm (or 1/4 up to 7.1/2" AF), in metric (mm) or inch (AF) sizes, for fine mechanics and heavy industry – MATADOR surely has the right spanner for your purpose.

Individual sizes made to measure.

Besides our comprehensive range of standardized and non-standardized sizes MATADOR also produces numerous special sizes and types according to your individual specifications – we will be pleased to assist you.



Ring spanners only with SmartDrive.

As one of the first tool manufacturers MATADOR introduced a special flank drive profile („SmartDrive“) for all ring spanners and sockets already more than 10 years ago. For more torque and less wear.

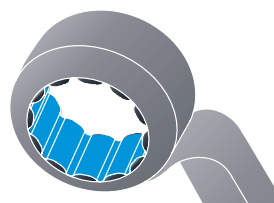

MATADOR's Classics.

Resilient. Accurate. Flat. Durable. Safe. Non-slip.
Non-glare. Simply good.



Good grip through Matt chrome finish.

Thanks to the complex galvanic treatment with nickel and chrome the spanners do not only get an efficient surface protection but also the perfect and well-known MATADOR look.

Matt chrome finished spanners are real and do not hide their inner values below a nice surface.

MATADOR spanners do not only lie better in your hand and have the edge over mirror-finished spanners when working with oil-smearred hands, they also offer great protection against chrome flaking off even under extreme load.

The thin but extremely durable nickel-chrome-coating with non-reflecting effect has proved itself in professional use and is still considered as industrial standard.

Double Open Ended Spanners



- Ideal for tightening hexagon screws and when bolts or cables block the way
- Torque values exceeding DIN standards
- Flat heads for use in confined spaces
- Good grip thanks to matt chrome-plated surface, also with oily hands
- Heads are grinded and polished fully automatically, for longer durability
- Jaws set at 15°

- Standards: DIN 3110 / ISO 3318 / 1085 / 10102
- Material: Chrome Vanadium
- Surface: Matt chrome finish

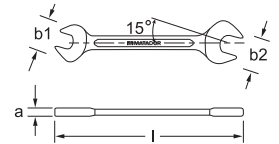

Art. Code	mm	l mm	a mm	b1 mm	b2 mm	g
0100 0405	4 x 5	103	3,2	12,5	14,0	10
0100 0555	5 x 5,5	122	3,2	14,0	16,0	10
0100 5507	5,5 x 7	122	3,3	16,0	17,5	20
0100 0607	6 x 7	122	3,3	16,0	17,5	20
0100 0809	8 x 9	136	3,7	20,0	22,0	25
0100 1011	10 x 11	152	4,5	24,0	27,0	40
0100 1013	10 x 13	172	5,1	26,0	30,5	55
0100 1213	12 x 13	172	5,1	28,5	30,5	70
0100 1415	14 x 15	185	5,5	31,5	33,5	90
0100 1617	16 x 17	201	5,9	35,5	38,5	110
0100 1719	17 x 19	221	6,9	40,0	43,0	155
0100 1819	18 x 19	221	6,9	40,0	43,0	155
0100 1922	19 x 22	235	7,2	44,0	48,0	210
0100 2022	20 x 22	235	7,2	44,0	48,0	210
0100 2123	21 x 23	245	7,4	47,0	51,0	240
0100 2224	22 x 24	245	7,4	47,0	51,0	240
0100 2427	24 x 27	265	8,4	54,0	57,0	320
0100 2528	25 x 28	275	8,4	56,0	61,5	480
0100 2730	27 x 30	275	8,4	56,0	62,5	500
0100 2732	27 x 32	299	9,4	59,5	68,5	530
0100 3032	30 x 32	299	9,4	62,5	68,5	550
0100 3236	32 x 36	325	9,6	68,5	74,5	650
0100 3641	36 x 41	358	9,8	74,5	84,0	830
0100 4146	41 x 46	400	10,3	84,0	93,5	830
0100 4650	46 x 50	450	11,6	95,5	102,0	1500
0100 5560	55 x 60	560	18,0	113,0	123,0	3160



MATADOR's Classics.

Carefully manufactured for generations.
Our classics.

The most important wrenches.

Even though the number of varieties has increased continuously, in the course of the decades four classic spanners have established that may not be missing in any tools assortment:

- Double Open Ended Spanners (DIN 3110)
- Angled Combination Spanners (DIN 3113 A)
- Offset Combination Spanners (DIN 3113 B)
- Double Ended Ring Spanners (DIN 838)



■ Double Open Ended Spanners Sets

- | | | |
|--|--------------|------------------------------------|
| - Tried and tested assortments of double open ended spanners | - Standards: | DIN 3110 / ISO 3318 / 1085 / 10102 |
| - All important sizes in one set | - Material: | Chrome Vanadium |
| - Sets in premium rollbag | - Surface: | Matt chrome finish |
| - Individual assortments on request | | |



Art. Code	g	
0100 9080 8 MM	740	1
Content 0100 6 x 7 - 8 x 9 - 10 x 11 - 12 x 13 - 14 x 15 - 16 x 17 - 18 x 19 - 20 x 22 mm		
0100 9120 12 MM	2150	1
Content 0100 6 x 7 - 8 x 9 - 10 x 11 - 12 x 13 - 14 x 15 - 16 x 17 - 18 x 19 - 20 x 22 - 21 x 23 - 24 x 27 - 25 x 28 - 30 x 32 mm		



■ Combination Spanners, angled



- Classic spanners with same sizes on both ends (1 size per spanner)
- With angled ring side
- All-purpose tool for tightening or countering screw joints
- High-grade, durable industrial quality
- Torque values exceeding DIN standards
- Flat heads for use in confined spaces
- Good grip thanks to matt chrome-plated surface, also with oily hands
- Heads are polished fully automatically, for longer durability of spanner and screws

- Jaws set at 15°
- Standards: DIN 3113 A / ISO 3318 / 7738
- Material: Chrome Vanadium
- Surface: Matt chrome finish

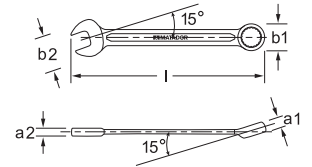

Art. Code	mm	l mm	a1 mm	a2 mm	b1 mm	b2 mm	g	
0185 0060	6	100	5,4	3,6	10,2	15,0	15	10
0185 0070	7	110	5,4	3,6	11,7	16,0	20	10
0185 0080	8	120	6,4	4,1	13,0	18,0	25	10
0185 0090	9	130	6,4	4,1	14,5	20,0	30	10
0185 0100	10	140	7,9	4,6	15,8	22,0	40	10
0185 0110	11	150	8,4	5,1	17,2	24,5	45	10
0185 0120	12	160	8,4	5,1	18,5	27,5	55	10
0185 0130	13	170	9,4	5,9	20,0	28,5	60	10
0185 0140	14	180	9,9	5,9	21,5	30,5	75	10
0185 0150	15	190	9,9	5,9	22,5	32,5	90	10
0185 0160	16	200	10,9	6,3	24,0	34,5	105	10
0185 0170	17	210	10,9	6,5	25,5	37,5	120	10
0185 0180	18	220	11,9	6,7	26,5	39,5	145	10
0185 0190	19	230	11,9	7,2	28,0	42,0	170	10
0185 0200	20	240	12,4	7,7	29,5	43,0	185	10
0185 0210	21	250	12,9	8,2	31,5	45,0	200	10
0185 0220	22	260	12,9	8,7	33,0	47,0	250	10
0185 0240	24	280	13,9	8,9	36,0	51,0	300	10
0185 0270	27	310	15,4	9,7	39,5	57,5	405	5
0185 0300	30	340	16,4	10,2	43,5	60,5	510	5
0185 0320	32	360	16,9	10,2	46,5	65,5	600	5
0185 0340	34	420	19,0	10,2	49,0	72,0	630	5



Art. Code	" AF	l mm	a1 mm	a2 mm	b1 mm	b2 mm	g	
0185 8001	1/4	105	5,6	3,8	10	16,0	20	10
0185 8002	5/16	120	6,8	4,2	13	17,0	30	10
0185 8003	3/8	154	8,0	4,6	16	24,0	50	10
0185 8004	7/16	166	8,6	4,8	17	26,0	60	10
0185 8005	1/2	190	9,8	5,4	20	30,0	80	10
0185 8006	9/16	203	10,4	5,8	22	32,0	100	10
0185 8007	5/8	227	11,6	6,6	25	36,0	135	10
0185 8008	11/16	239	12,2	7	26	38,0	155	10
0185 8009	3/4	230	11,5	7	27,5	42,0	190	10
0185 8010	13/16	250	12,5	8,6	32	46,0	260	10
0185 8011	7/8	300	14,6	9	34	48,0	310	10
0185 8012	15/16	277	13,5	8,5	35	49,0	300	5
0185 8013	1	330	15,6	9,6	38	52,0	380	5
0185 8014	1,1/16	310	15,5	10	39	57,0	470	5
0185 8015	1,1/8	360	17,0	10	43	58,0	470	5
0185 8016	1,1/4	420	20,0	12	48	66,0	775	5

Equally sized Ring Spanners.

Angled or offset?

Ring Spanners are available in two different versions:

Angled (as per DIN 3113 Form A)
or offset (as per DIN 3113 Form B).

Depending on the case of application both versions have their specific advantages and disadvantages.

Angled ring spanners are flatter and shorter than offset ring spanners and are also lower priced.

But especially in case of deep or hardly accessible screw joints offset ring spanners have the edge over the angled form A. They are longer, have a thicker ring head and can thus reach higher torque values so that particularly professional users give their preference to offset type spanners.

Thus MATADOR - as a manufacturer of tools for professional application - has a much larger range of offset type ring spanners than of angled ring spanners.

Further sizes are available on request.

DIN 3113 A



Flatter angle of DIN 3113 A compared to DIN 3113 B

DIN 3113 B

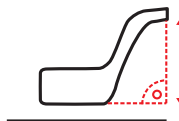

DIN 3113 A



Thinner head of DIN 3113 A compared to DIN 3113 B

DIN 3113 B

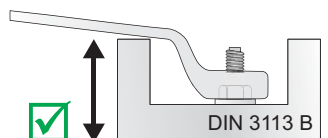
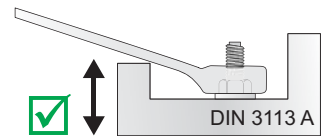
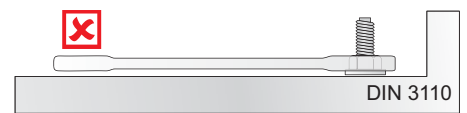

Combination Spanners Sets

- Tried and tested assortments of angled combination spanners
- All important sizes in one set
- Sets in premium rollbag
- From 6 to 22 mm or from 6 to 32 mm and from 5/16 to 1" AF in different assortments

- Standards: DIN 3113 A / ISO 3318 / 7738
- Material: Chrome Vanadium
- Surface: Matt chrome finish



Art. Code	g	
0185 9080 8 MM	840	1
Content 0185 8 - 10 - 11 - 13 - 14 - 17 - 19 - 22 mm		
0185 9100 10 MM	655	1
Content 0185 6 - 7 - 8 - 9 - 10 - 11 - 13 - 14 - 17 - 19 mm		
0185 9120 12 MM	995	1
Content 0185 6 - 7 - 8 - 9 - 10 - 11 - 13 - 14 - 17 - 19 - 20 - 22 mm		
0185 9160 16 MM	2670	1
Content 0185 6 - 7 - 8 - 9 - 10 - 11 - 12 - 13 - 14 - 17 - 19 - 22 - 24 - 27 - 30 - 32 mm		
0185 9170 17 MM	1690	1
Content 0185 6 - 7 - 8 - 9 - 10 - 11 - 12 - 13 - 14 - 15 - 16 - 17 - 18 - 19 - 20 - 21 - 22 mm		
0185 9121 12 AF	1735	1
Content 0185 5/16 - 3/8 - 7/16 - 1/2 - 9/16 - 5/8 - 11/16 - 3/4 - 13/16 - 7/8 - 15/16 1" AF		



■ Combination Spanners, offset (MM)



- Classic spanners with same sizes on both ends (1 size per spanner)
- With polished and offset ring side
- All-purpose tool for tightening or countering screw joints
- High-grade, durable industrial quality
- Torque values exceeding DIN standards
- Flat heads for confined spaces
- Good grip thanks to matt chrome-plated surface, also with oily hands
- Grinded for longer durability of spanner and screws
- Jaws set at 15°
- Standards: DIN 3113 B / ISO 3318 / 7738
- Material: Chrome Vanadium
- Surface: Matt chrome finish

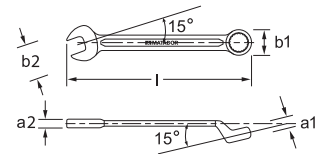

Art. Code	mm	l mm	a1 mm	a2 mm	b1 mm	b2 mm	g
0190 0060	6	100	5,3	3,9	10,0	15,5	20
0190 0070	7	112	5,8	3,9	11,5	16,5	25
0190 0080	8	124	6,3	4,4	13,0	18,5	30
0190 0090	9	136	6,8	4,4	14,5	20,3	35
0190 0100	10	147	7,4	4,9	16,0	22,3	50
0190 0110	11	159	7,8	5,3	17,5	25,3	55
0190 0120	12	171	8,4	5,3	18,2	28,3	65
0190 0130	13	183	9,0	6,2	19,5	29,2	75
0190 0140	14	195	9,8	6,4	21,5	31,0	100
0190 0150	15	207	9,8	6,7	22,5	33,0	105
0190 0160	16	219	10,3	7,1	23,7	35,0	120
0190 0170	17	232	10,4	7,5	25,3	38,0	170
0190 0180	18	243	11,4	7,7	26,8	40,0	155
0190 0190	19	256	11,8	7,9	28,0	41,0	200
0190 0200	20	268	12,0	8,4	29,5	41,5	240
0190 0210	21	279	12,3	8,7	31,5	45,5	250
0190 0220	22	292	12,4	8,9	33,0	48,0	265
0190 0230	23	315	12,8	9,5	35,5	49,5	265
0190 0240	24	315	12,8	9,5	35,5	49,5	400
0190 0250	25	315	12,8	9,5	35,5	49,5	400
0190 0260	26	349	14,3	10,5	39,5	56,5	400
0190 0270	27	349	14,3	10,5	39,5	56,5	485
0190 0280	28	385	15,4	10,9	43,5	63,0	620
0190 0290	29	385	15,4	10,9	43,5	63,0	610
0190 0300	30	385	15,4	10,9	43,5	63,0	610
0190 0320	32	408	16,2	11,1	46,0	67,5	780
0190 0330	33	412	20,5	11,8	47,5	70,5	800
0190 0340	34	412	20,5	11,8	49,0	70,5	840
0190 0360	36	460	23,5	12,8	52,2	76,2	1160
0190 0380	38	460	24,2	13,2	56,0	79,2	1450
0190 0410	41	520	25,5	14,0	60,2	85,0	1120
0190 0460	46	550	27,5	15,0	68,0	95,5	2250
0190 0500	50	580	29,5	16,0	74,0	103,0	2800
0190 0550	55	620	30,5	17,0	82,0	112,5	3600
0190 0600	60	660	32,0	18,0	90,0	121,0	4400
0190 0650	65	710	33,0	22,0	98,0	133,0	4500
0190 0700	70	760	35,0	24,0	105,0	143,0	5600
0190 0750	75	810	38,0	26,0	110,0	153,0	6780
0190 0800	80	860	41,0	28,0	119,0	163,0	8780



■ Combination Spanners, offset (AF)

Art. Code	* AF	l mm	a1 mm	a2 mm	b1 mm	b2 mm	g
0190 8001	1/4	105	5,5	4,3	11,4	16,2	20
0190 8002	5/16	125	6,7	4,7	14,2	20,3	30
0190 8003	3/8	150	7,9	5,1	16,7	24,3	50
0190 8004	7/16	160	8,5	5,3	17,9	26,4	55
0190 8005	1/2	185	9,7	5,9	20,7	30,5	75
0190 8006	9/16	195	10,2	6,3	22,3	32,5	90
0190 8007	19/32	195	10,8	6,7	23,6	34,5	105
0190 8008	5/8	220	11,4	7,1	25,1	36,5	120
0190 8009	11/16	250	12,0	7,5	26,6	38,5	135
0190 8010	3/4	255	12,8	8,3	29,5	42,5	200
0190 8011	13/16	280	12,5	9,1	31,0	45,0	240
0190 8012	7/8	290	14,4	9,4	34,5	48,7	265
0190 8013	15/16	295	14,4	9,4	34,5	48,7	365
0190 8014	1	329	15,4	9,8	38,0	52,7	400
0190 8015	1,1/16	350	16,7	10,6	40,5	56,0	485
0190 8016	1,1/8	360	16,7	10,6	41,8	59,0	485
0190 8017	1,1/4	410	16,7	11,0	46,0	67,0	780
0190 8018	1,5/16	435	20,5	12,2	48,5	70,5	780
0190 8019	1,3/8	460	21,2	13,0	53,8	76,0	1000
0190 8020	1,7/16	460	21,2	13,0	53,8	76,0	1000
0190 8021	1,1/2	460	24,2	13,2	56,0	79,2	1400
0190 8022	1,5/8	520	25,5	14,0	60,5	85,0	1400
0190 8023	1,11/16	470	22,0	13,5	62,0	85,0	1400
0190 8024	1,3/4	550	27,5	15,0	66,0	95,5	2200
0190 8025	1,13/16	550	27,5	15,0	68,0	95,5	2250
0190 8026	1,7/8	550	27,5	15,0	69,0	95,5	2300
0190 8027	2	580	29,5	16,0	74,5	103,0	2800



■ Combination Spanners Sets

- Tried and tested assortments of offset type combination spanners
- Standards: DIN 3113 B / ISO 3318 / 7738
- All important sizes in one set
- Material: Chrome Vanadium
- Sets in premium rollbag
- Surface: Matt chrome finish

Art. Code	Content	g
0190 9080	8 MM	600
Content	0190 8 - 9 - 10 - 11 - 13 - 14 - 17 - 19 mm	1
0190 9120	12 MM	1175
Content	0190 8 - 9 - 10 - 11 - 12 - 13 - 14 - 15 - 16 - 17 - 18 - 19 mm	1
0190 9121	12 MM	1300
Content	0190 6 - 7 - 8 - 9 - 10 - 11 - 12 - 13 - 14 - 17 - 19 - 22 mm	1
0190 9122	12 MM	3200
Content	0190 10 - 11 - 12 - 13 - 14 - 17 - 19 - 22 - 24 - 27 - 30 - 32 mm	1
0190 9160	16 MM	3220
Content	0190 6 - 7 - 8 - 9 - 10 - 11 - 12 - 13 - 14 - 17 - 19 - 22 - 24 - 27 - 30 - 32 mm	1
0190 9170	17 MM	1920
Content	0190 6 - 7 - 8 - 9 - 10 - 11 - 12 - 13 - 14 - 15 - 16 - 17 - 18 - 19 - 20 - 21 - 22 mm	1
0190 9260	26 MM	4500
Content	0190 6 - 7 - 8 - 9 - 10 - 11 - 12 - 13 - 14 - 15 - 16 - 17 - 18 - 19 - 20 - 21 - 22 - 23 - 24 - 25 - 26 - 27 - 28 - 29 - 30 - 32 mm	1
0190 9161	16 AF	3365
Content	0190 1/4 - 5/16 - 3/8 - 7/16 - 1/2 - 9/16 - 19/32 - 5/8 - 11/16 - 3/4 - 13/16 - 7/8 - 15/16 1 - 1.1/16 - 1.1/4 , AF	1



Double Ended Ring Spanners



- Classic spanners with deeply offset double ring profile for deep-set screw joints
 - 2 sizes per spanner
 - High-grade, durable industrial quality
 - Good grip thanks to matt chrome-plated surface, also with oily hands
 - Heads fully automatically grinded, for longer durability of spanner and screws
- Standards: DIN 838 / ISO 3318 / 1085 / 10104
 - Material: Chrome Vanadium
 - Surface: Matt chrome finish

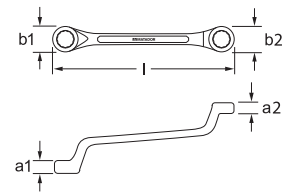

Art. Code	mm	l mm	a1 mm	a2 mm	b1 mm	b2 mm	g	
0200 0607	6 x 7	167	5,6	6,2	10,4	12,0	40	10
0200 0809	8 x 9	182	6,4	7,1	13,4	15,0	60	10
0200 0810	8 x 10	182	6,4	7,1	13,4	16,0	60	10
0200 1011	10 x 11	197	7,5	8,0	16,0	17,8	75	10
0200 1013	10 x 13	216	8,5	9,1	16,0	21,0	110	10
0200 1213	12 x 13	216	8,5	9,1	19,3	21,0	110	10
0200 1317	13 x 17	263	10,3	10,7	22,0	26,5	240	10
0200 1415	14 x 15	216	9,7	10,7	21,8	22,7	110	10
0200 1617	16 x 17	263	10,3	10,7	25,0	26,5	240	10
0200 1719	17 x 19	290	11,0	11,3	27,5	29,0	300	10
0200 1819	18 x 19	290	11,0	11,3	27,5	29,0	300	10
0200 1922	19 x 22	318	11,7	12,4	29,0	33,5	305	10
0200 2022	20 x 22	318	11,7	12,4	29,0	33,5	305	10
0200 2123	21 x 23	325	12,2	13,0	32,0	35,0	360	5
0200 2224	22 x 24	325	12,2	13,0	34,0	37,0	360	5
0200 2426	24 x 26	337	13,0	14,0	36,1	40,0	430	5
0200 2427	24 x 27	337	13,0	14,0	36,1	40,0	430	5
0200 2528	25 x 28	346	13,2	14,5	38,0	42,0	450	5
0200 3032	30 x 32	360	15,2	16,5	43,7	46,0	620	5
0200 3236	32 x 36	410	16,0	17,5	50,0	52,0	950	5
0200 3641	36 x 41	440	17,5	19,0	52,0	60,0	1 100	5
0200 4146	41 x 46	475	19,5	21,0	60,0	67,0	1 280	5
0200 4650	46 x 50	536	19,7	20,6	61,0	68,0	1 390	1
0200 5560	55 x 60	610	24,6	25,6	84,9	91,8	3 150	1



Art. Code	" AF	l mm	a1 mm	a2 mm	b1 mm	b2 mm	g	
0200 8001	1/4 x 5/16	176	5,8	6,4	12,0	14,5	55	10
0200 8002	3/8 x 7/16	206	8,5	9,0	16,0	17,2	115	10
0200 8003	7/16 x 1/2	221	9,5	9,8	18,7	20,0	135	10
0200 8004	1/2 x 9/16	245	9,5	10,2	21,7	23,5	145	10
0200 8005	5/8 x 11/16	271	12,0	12,8	26,0	29,0	270	5
0200 8006	3/4 x 25/32	271	12,4	12,8	27,5	29,0	270	5
0200 8007	13/16 x 7/8	311	13,6	14,2	32,0	35,0	400	5
0200 8008	15/16 x 1	331	14,4	15,0	36,5	39,5	495	5
0200 8009	1,1/16 x 1,1/4	371	15,4	17,0	40,7	47,5	640	5

MATADOR SmartDrive. The intelligent profile.

Goes easy on the tool and the screw.

Conventional „angular“ hexagon or double hexagon profiles transfer considerable tightening and separation forces to the edges of the screw heads.

The consequences:

- Lower traction
- Deformed screw heads
- Less contact surface when screw heads are rounded

As one of the first tool manufacturers MATADOR introduced a special flank drive profile („SmartDrive“) for all ring spanners and sockets already more than 10 years ago.

Spanners with MATADOR Smart-Drive profile transfer forces to the flanks of the screw head, not to the edges. Thanks to this flank drive profile the spanners can work on double the contact surface than conventional spanners.

The advantages:

- Optimized traction, even on screws with rounded edges
- Higher torque values
- Ideal protection of the screws and nuts

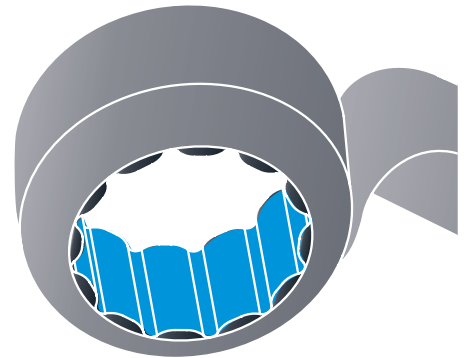

Conventional profile:

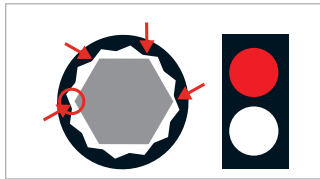

Less traction with angular double hexagon profiles

Conventional profile:

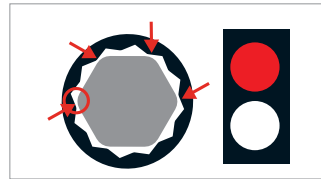

Hardly any traction on screws with rounded edges

MATADOR SmartDrive:

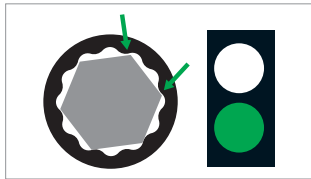

Perfect traction also on screws with rounded edges

MATADOR SmartDrive:

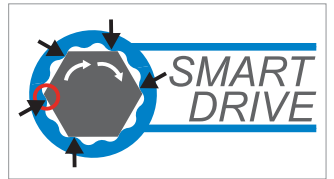

■ Double Ended Ring Spanners Sets

- Tried and tested assortments of ring spanners, all important sizes in one set
 - High-grade, durable industrial quality
 - Good grip thanks to matt chrome-plated surface, also with oily hands
 - Fully automatically grinded heads, for longer durability of spanner and screws
 - Sets in premium rollbag
 - Individual assortments on request
- Standards: DIN 838 / ISO 3318 / 1085 / 10104
 - Material: Chrome Vanadium
 - Surface: Matt chrome finish



Art. Code		g	
0200 9080	8 MM	1265	1
Content	0200 6 x 7 - 8 x 9 - 10 x 11 - 12 x 13 - 14 x 15 - 16 x 17 - 18 x 19 - 20 x 22 mm		
0200 9100	10 MM	2355	1
Content	0200 6 x 7 - 8 x 9 - 10 x 11 - 12 x 13 - 14 x 15 - 16 x 17 - 18 x 19 - 20 x 22 - 24 x 27 - 30 x 32 mm		
0200 9120	12 MM	3310	1
Content	0200 6 x 7 - 8 x 9 - 10 x 11 - 12 x 13 - 14 x 15 - 16 x 17 - 18 x 19 - 20 x 22 - 21 x 23 - 24 x 27 - 25 x 28 - 30 x 32 mm		
0200 9081	8 AF	2180	1
Content	0200 1/4 x 5/16 - 3/8 x 7/16 - 1/2 x 9/16 - 5/8 x 11/16 - 3/4 x 25/32 - 13/16 x 7/8 - 15/16 x 1 - 1,1/16 x 1,1/4 , AF		

■ Magnetic Spanners Set



- For fine mechanics, model making etc.
- 10 mini tools on ring, consisting of 8 mini open ended spanners, 1 contact file with slotted screwdriver, 1 feeler gauge 0.40 mm
- Material: Sheet steel, hardened
- Surface: Nickel-plated

Art. Code	g	
0158 0001 19 MM	50	1
Content 0145 4 - 4,5 - 5 - 5,5 - 6 - 6,5 - 7 - 7,5 mm		



The right spanner for screw and nut.

The width across flats (SW) of a spanner defines the „size“ of the spanner, e.g. SW 13 for 13 mm. The mm and inch units are stamped into the spanner.

Screws and nuts are classified through the nominal diameter (d) of their thread and thus identified e.g. as „M 6“.

Thread diameter and width of the spanner are not identical. The correct spanner-screw combination can be seen from the alongside table:



Spanner sizes for hexagon nuts and screws are defined as per DIN ISO 272. E.g. according to this standard a nut sized M 8 requires a spanner sized 13 mm.

According to the previously valid DIN 931 and 933 the required spanner size for M 10 screws was 17 mm and 19 mm for M 12 screws.

	M 2	M 2,5	M 3	M 4	M 5	M 6	M 8
	SW 4	SW 5	SW 5,5	SW 7	SW 8	SW 10	SW 13
	M 10	M 12	M 14	M 16	M 18	M 20	M 22
	SW 16 (SW 17)	SW 18 (SW 19)	SW 22	SW 24	SW 27	SW 30	SW 32

Values in brackets = old values are the previously applicable DIN 931 / 933

Due to the transformation of the DIN into the international ISO standard the correct spanner sizes became 16 and 18 mm leading to an increased importance of spanners sized 16 and 18 mm.

■ Adjustable Single Ended Spanner



- Individual versatile single ended spanner, thanks to its continuous setting
- Wide range: 6 - 24 mm
- Good grip thanks to knurly spool
- With ergonomic non-slip rubber handle
- With practical hole for hooks

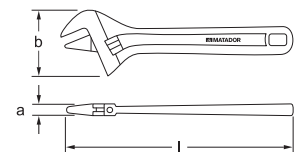

Art. Code	mm	" AF	l "	l mm	a mm	b mm	mm	g	
0590 0080	6-24	0-1	8	200	13,5	57	0-25	250	1

Adjustable Single Ended Spanners. One for all.

The practical allround spanner.

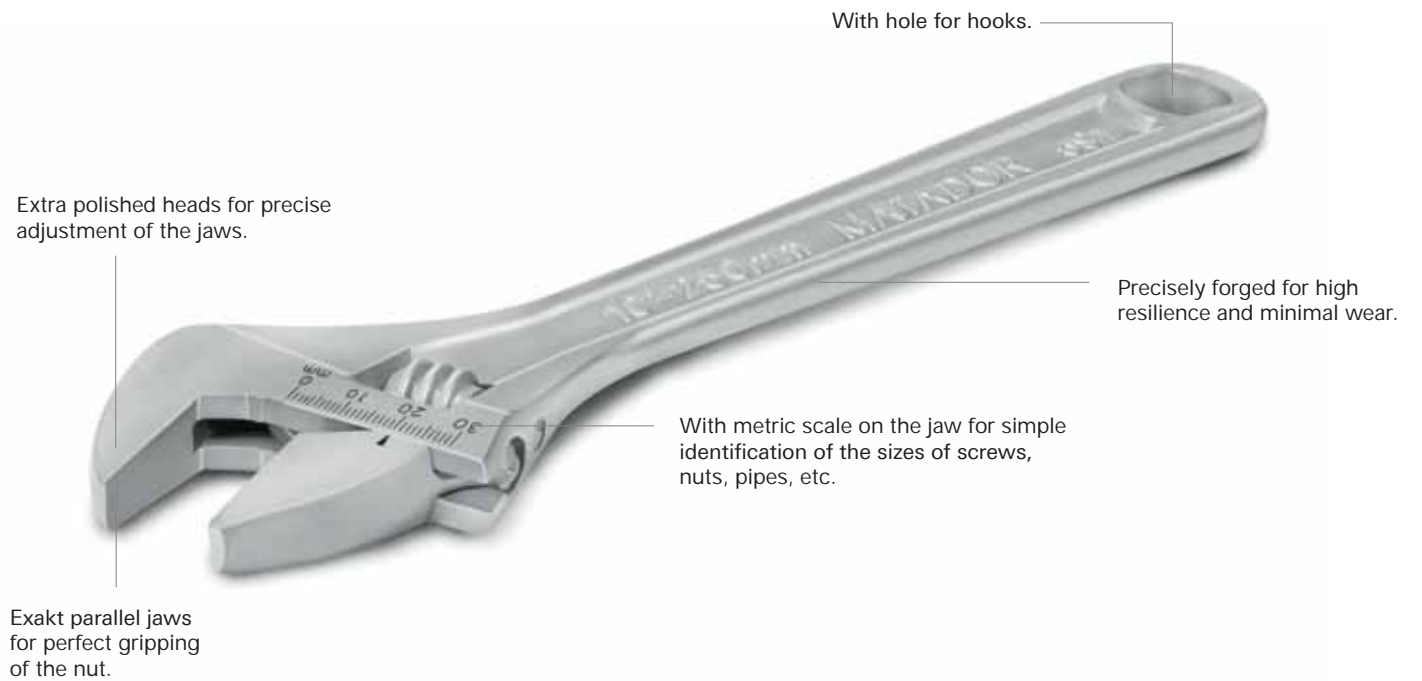

Adjustable Spanners

- Several sizes per spanner
- High-grade, durable industrial quality
- Good grip thanks to matt chrome-plated surface, also with oily hands
- Swedish type with anticlockwise spool
- Jaws set at 15°
- Standards: DIN 3117 Form A ISO 6787-1982

- Material: Chrome Vanadium (6 - 12")
Tempered steel (15 - 18")
- Surface: Matt chrome finish

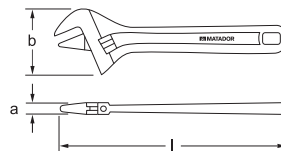

Art. Code	mm	*AF	l"	l mm	a mm	b mm	mm	g	
0591 0040	0-13	0-1/2	4	100	12.5	46	0-13	140	1
0591 0060	0-20	0-25/32	6	150	12.5	46	0-20	140	1
0591 0080	0-25	0-1	8	200	13.5	57	0-25	250	1
0591 0100	0-30	0-1.3/16	10	250	16	66	0-30	390	1
0591 0120	0-40	0-1.9/16	12	300	20	82	0-40	630	1
0591 0150	0-43	0-1.11/16	15	375	25	105	0-45	950	1



MATADOR Ratchet Spanners. If time is short.

The most important innovation since the invention of spanners.



Made of CHROME VANADIUM Steel for high resilience and minimal wear.

Exceeds the torque values of standard combination spanners.

With 72 teeth.

With patented GEARplus[®] technique.



2 in 1: Ratchet Spanners.

MATADOR Ratchet Spanners combine the advantages of a ratchet with those of a slim spanner:

The ultra slim design of the ring side allows fast working in confined spaces, even where conventional ratchets with sockets are not applicable. For instance the thickness of the ring side of a ratchet spanner is only 1/5 of the height of a standard ratchet with socket.

The open ended side is appropriate for all screw connections where bolts or cables block the way.

Higher torque value in most confined spaces.

MATADOR relies on the tried and tested GEARplus[®] technique which is made of specially hardened and Tempered steel.

The progressive toothting of the inserted ratchet gear allows the transmission of up to 30% more torque compared to previous ratchet spanners and reaches and even exceeds the DIN / ISO torque standards for standard combination spanners.

Thanks to the ratcheting angle of only 5° and the 72 teeth ratchet mechanism screw connections can be tightened or loosened at a previously unknown speed – without resetting.

With MATADOR SmartDrive profile.

Of course, all MATADOR ratchet spanners are provided with MATADOR SmartDrive profile.

MATADOR SmartDrive profile transmits forces at 100% to the flanks of the screw head or the nut, not to the edges. Thanks to this flank drive profile the spanners work on double the contact surface than conventional spanners, even rounded screws are no problem.

The advantages:

- Optimized traction, even on screws with rounded edges
- Higher torque values
- Ideal protection of the screws and nuts

What are the benefits of ratchet spanners?

One can no longer imagine a modern workshop without ratchet spanners.

Meanwhile millionfold tried and tested ratchet spanners often replace the use of standard ratchets and spanners. Through the flat design they reach spaces where standard reversible ratchets with sockets cannot be used.

Thanks to the innovative ratchet technique screws can be tightened up to 7x faster because there is no need for resetting the tool.

And by the way ratchet spanners reach nearly identical torque values compared to standard spanners.

Powerful, flat, fast.

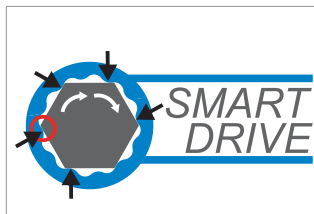
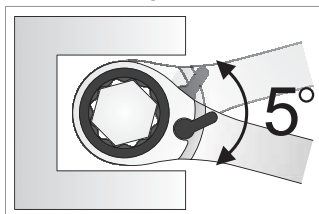
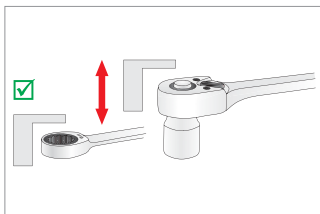



■ Combination Ratchet Spanners, straight

- Combination ratchet spanners, straight type
- With 72 teeth, very high torque values (exceeding DIN 3110 / ISO 3318)
- With patented ratchet gear (GEARplus®) made of special steel with 72 teeth
- Simply turn around for clockwise / anticlockwise use
- Jaws set at 15°
- Standards: Similar to DIN 3113 A, ISO 3318 / 7738
- Material: Chrome Vanadium
- Surface: Matt chrome finish

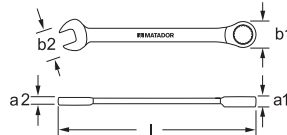

Art. Code	mm	l mm	a1 mm	a2 mm	b1 mm	b2 mm	g
0183 0060	6	128	6,3	3,9	14,0	15,0	25
0183 0070	7	140	6,5	4,0	16,8	16,7	30
0183 0080	8	140	6,5	4,0	16,8	16,7	30
0183 0090	9	149	6,9	4,4	18,8	18,7	40
0183 0100	10	158	7,3	4,8	20,8	20,8	50
0183 0110	11	165	7,7	5,2	21,8	23,0	60
0183 0120	12	171	8,2	5,5	22,8	24,6	70
0183 0130	13	178	8,6	5,8	24,8	26,8	80
0183 0140	14	190	9,0	6,2	27,8	29,0	110
0183 0150	15	199	9,4	6,5	28,8	31,0	120
0183 0160	16	208	9,9	6,8	30,8	33,0	150
0183 0170	17	225	10,3	7,2	31,8	35,5	180
0183 0180	18	236	10,7	7,7	32,8	37,5	210
0183 0190	19	247	11,2	8,2	33,8	39,4	240
0183 0220	22	289	13,0	9,0	40,0	45,8	340
0183 0240	24	322	14,5	10,0	46,0	51,8	470
0183 0270	27	358	15,5	10,5	52,0	56,4	580
0183 0300	30	401	17,0	11,4	58,0	62,7	860
0183 0320	32	424	17,5	12,5	62,0	66,4	1060



■ Combination Ratchet Spanners Sets

- Tried and tested assortments of combination ratchet spanners, straight type
- All important sizes in one set

Art. Code	g
0183 9050 5 MM	600
Content: 0183 8 - 10 - 13 - 17 - 19 mm	
0183 9080 8 MM	790
Content: 0183 8 - 9 - 10 - 11 - 13 - 14 - 17 - 19 mm	
0183 9120 12 MM	1400
Content: 0183 8 - 9 - 10 - 11 - 12 - 13 - 14 - 15 - 16 - 17 - 18 - 19 mm	
0189 9050 5 MM	600
Content: 0183 8 - 10 - 13 - 17 - 19 mm	
0189 9080 8 MM	790
Content: 0183 8 - 9 - 10 - 11 - 13 - 14 - 17 - 19 mm	
0189 9120 12 MM	1400
Content: 0183 8 - 9 - 10 - 11 - 12 - 13 - 14 - 15 - 16 - 17 - 18 - 19 mm	



■ Combination Ratchet Spanners, angled



- Combination ratchet spanners, angled type, jaws set at 15°
- With 72 teeth, very high torque values (exceeding DIN 3110 / ISO 3318)
- With patented ratchet gear (GEARplus®) made of special steel with 72 teeth
- With switch lever
- Standards: Similar to DIN 3113 A / ISO 3318 / 7738

- Material: Chrome Vanadium
- Surface: Matt chrome finish

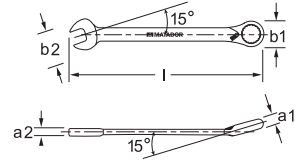

Art. Code	mm	l mm	a1 mm	a2 mm	b1 mm	b2 mm	g	
0189 0060	6	126	6,3	3,9	14,0	15,0	30	10
0189 0070	7	145	6,5	4,6	16,6	16,7	30	10
0189 0080	8	145	6,5	4,6	16,6	16,7	30	10
0189 0090	9	150	6,9	4,9	18,4	18,8	40	10
0189 0100	10	145	7,3	5,3	20,0	20,8	50	10
0189 0110	11	165	7,7	5,6	21,8	23,0	60	10
0189 0120	12	172	8,2	6,0	22,7	25,0	70	10
0189 0130	13	165	8,6	6,4	24,7	27,1	80	10
0189 0140	14	190	9,0	6,8	27,0	29,2	100	10
0189 0150	15	200	9,4	7,0	28,3	31,3	120	10
0189 0160	16	208	9,9	7,2	30,0	33,4	150	10
0189 0170	17	225	10,3	7,7	31,8	35,5	160	10
0189 0180	18	237	10,7	8,2	32,6	37,6	190	10
0189 0190	19	248	11,2	8,8	33,8	39,7	220	10
0189 0220	22	290	13,0	9,0	40,0	46,0	360	5
0189 0240	24	323	14,5	10,0	46,0	52,2	470	5
0189 0270	27	331	15,5	10,5	52,5	56,5	660	5
0189 0300	30	389	17,0	11,4	58,5	62,7	860	5
0189 0320	32	415	17,5	12,4	62,6	66,4	1050	5

■ Adapters for Ratchet Spanners



- Makes an ultra-flat ratchet out of a ratchet spanner (10 mm = 1/4" or 1/4" Bit, 13 mm = 3/8" and 19 mm = 1/2")
- With push-button quick-release function
- Applicable for ratchet spanners with GEARplus® technique

- Standards: DIN 3120 / ISO 1174 DIN 3126 / C 6,3
- Material: Chrome Vanadium
- Surface: Polished chrome finish

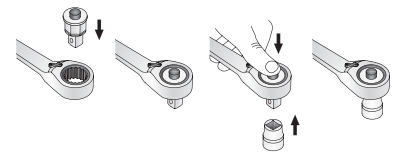
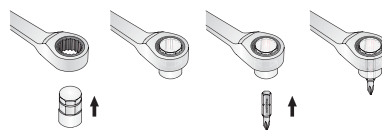

Art. Code	g	
0186 0010	60	1
Content	0186 6,3 (1/4) Bit - 6,3 (1/4) - 10 (3/8) - 12,5 (1/2) mm	

4in1 Ratchet Spanner.

Suitable for 70% of all screw tasks.

Ideal for mobile use.



70% is more than two thirds.

MATADOR's „4in1“ ratchet spanner must not be missing in any modern tools assortment.

70% of all screws and nuts need a spanner size of 10, 13, 17 or 19 mm - and this is exactly what the „4in1“ ratchet spanner provides. Especially in cases when a complete spanner set is not at hand (e.g. during mobile use) 70% of all possible screw tasks (thus more than two thirds!) can be solved only with this single spanner - with torque values exceeding those of a standard spanner.

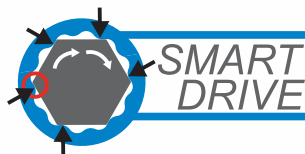

4in1 Ratchet Spanner

- 4 ratchet spanners in one tool, combines 10, 13, 17 and 19 mm
- For 70% of all screw tasks
- With patented ratchet gear (“Reverse Gear”) made of special steel with 120 teeth
- Transmits very high torque values
 - Size 10 x 13 = max. 138 Nm
 - Size 17 x 19 = max. 387 Nm

- Only 3° ratcheting angle thanks to 120 teeth - especially suitable for confined spaces
- Material: Chrome Vanadium
- Surface: Matt chrome finish

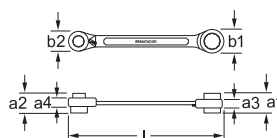

Art. Code	mm	l mm	a1/a3 mm	a2/a4 mm	b1 mm	b2 mm	g	
0184 0001	10,13,17,19	190	21,9 / 11,2	17,1 / 9,0	33,6	21,9	196	1



MATADOR Slogging Spanners.

Rise to the challenge.



■ Slogging Open Ended Spanners (MM)



- Tried and tested MATADOR classic
 - For tightening and loosening of big screw joints, e.g. in heavy industry, shipbuilding, plant construction, etc.
 - Ideal for the use with club hammer or air hammer
 - Precisely drop-forged
 - Very high impact strength
 - Up to 500 mm made of Chrome Vanadium steel 31 CrV 3, from 525 mm made of C 35
 - With zinc-plated surface for durable rust protection - not only sandblasted / oiled
- Standards: DIN 133 (except for special sizes *)
 - Material: 31 CrV 3 / C 35
 - Surface treatment: Zinc-plated

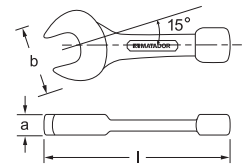

Art. Code	mm	l mm	a mm	b mm	g
0175 0220	22*	180	16,0	55,0	280
0175 0240	24*	180	16,0	55,0	280
0175 0260	26*	180	16,0	57,0	210
0175 0270	27	180	16,5	57,5	385
0175 0280	28*	180	16,0	57,0	280
0175 0300	30	190	17,0	63,5	451
0175 0320	32	195	17,5	66,5	552
0175 0340	34	195	17,5	66,5	559
0175 0350	35*	215	19,0	76,0	745
0175 0360	36	210	18,5	75,5	709
0175 0370	37*	215	19,0	76,0	740
0175 0380	38*	215	19,0	76,0	680
0175 0400	40*	235	19,0	86,0	900
0175 0410	41	225	19,5	88,0	1000
0175 0420	42*	235	19,0	86,0	900
0175 0450	45*	255	20,0	98,0	1200
0175 0460	46	255	20,0	98,0	1258
0175 0470	47*	255	20,0	98,0	1200

Art. Code	mm	l mm	a mm	b mm	g
0175 0480	48*	255	20,0	98,0	1275
0175 0500	50	280	21,5	108,0	1609
0175 0520	52*	275	21,0	105,0	1450
0175 0550	55	310	24,0	118,5	2131
0175 0560	56*	300	23,0	116,0	1900
0175 0600	60	320	24,5	129,5	2484
0175 0640	64*	345	27,0	138,0	3300
0175 0650	65	342	28,0	140,5	3340
0175 0700	70	370	30,0	151,0	4325
0175 0750	75	400	31,5	163,0	5110
0175 0800	80	405	34,5	174,0	6020
0175 0850	85	405	34,5	174,0	5770
0175 0900	90	455	39,0	195,0	8905
0175 0950	95	455	39,0	195,0	8985
0175 1000	100	500	47,0	227,0	13315
0175 1050	105	500	47,0	227,0	13220
0175 1100	110	500	47,0	227,0	13045
0175 1150	115	525	55,0	246,5	17660

Art. Code	mm	l mm	a mm	b mm	g	
0175 1200	120	525	55,0	246,5	17610	1
0175 1250	125*	545	50,0	255,0	16760	1
0175 1300	130	575	55,0	275,0	19030	1
0175 1350	135	575	55,0	275,0	18880	1
0175 1400	140*	575	55,0	275,0	17880	1
0175 1450	145	640	60,0	305,0	26665	1
0175 1500	150	640	60,0	305,0	24660	1
0175 1550	155	640	60,0	305,0	24200	1
0175 1600	160*	640	60,0	305,0	25690	1
0175 1650	165	715	70,0	342,0	39560	1
0175 1700	170	715	70,0	342,0	37760	1
0175 1750	175*	715	70,0	342,0	36840	1
0175 1800	180*	715	70,0	392,0	37000	1
0175 1850	185*	715	70,0	392,0	36000	1
0175 1900	190*	800	78,0	392,0	53300	1
0175 1950	195*	800	78,0	392,0	52900	1
0175 2000	200*	800	78,0	392,0	52500	1
0175 2050	205*	800	78,0	392,0	52500	1
0175 2100	210*	800	78,0	392,0	51700	1
0175 2150	215*	800	78,0	392,0	51300	1
0175 2200	220*	800	72,0	415,0	51300	1

* Made to order, no general stock size

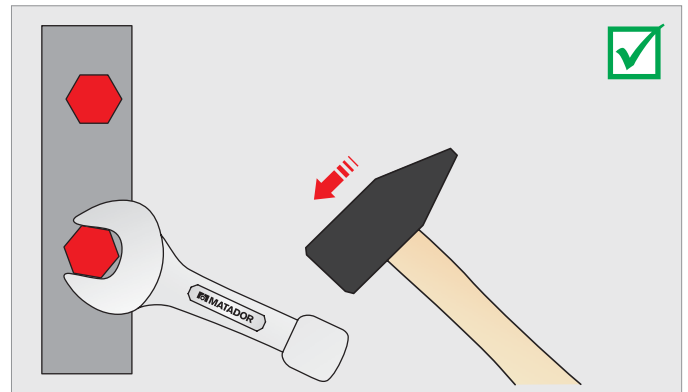

MATADOR Slogging Spanners.

Rise to the challenge.



■ Slogging Ring Ended Spanners (MM)



- Tried and tested MATADOR classic
 - For tightening and loosening of big screw joints, e.g. in heavy industry, shipbuilding, plant construction, etc.
 - Ideal for the use with club hammer or air hammer
 - Precisely drop-forged
 - Very high impact strength
 - Up to 435 mm made of Chrome Vanadium steel 31 CrV 3, from 480 mm made of C 35
 - With zinc-plated surface for durable rust protection - not only sandblasted / oiled
- Standards: DIN 7444 (except for special sizes *)
 - Material: 31 CrV 3 / C 35
 - Surface treatment: Zinc-plated

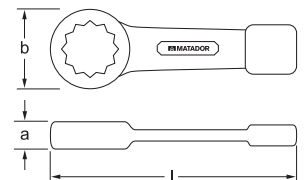

Art. Code	mm	l mm	a mm	b mm	g
0270 0220	22*	165	15,0	43,0	220
0270 0240	24*	160	15,0	42,5	250
0270 0270	27	180	15,5	47,0	350
0270 0300	30	190	16,5	52,5	400
0270 0320	32	195	16,5	54,0	450
0270 0340	34	195	16,5	54,0	600
0270 0360	36	205	19,5	60,0	750
0270 0380	38*	205	19,5	60,0	660
0270 0410	41	225	20,5	66,0	850
0270 0460	46	240	22,5	75,0	1050
0270 0500	50	250	23,5	80,0	1250
0270 0550	55	270	25,0	87,5	1550
0270 0560	56*	270	25,0	86,0	1400
0270 0600	60	270	26,0	93,5	1650
0270 0650	65	290	29,0	101,0	2300
0270 0700	70	320	32,5	109,5	2600
0270 0750	75	325	34,0	114,5	3350

Art. Code	mm	l mm	a mm	b mm	g
0270 0800	80	345	35,0	123,0	3800
0270 0850	85	360	37,0	129,0	4200
0270 0900	90	400	41,5	152,0	5700
0270 0950	95	400	41,5	152,0	5700
0270 1000	100	400	41,5	152,0	5700
0270 1050	105	435	47,5	172,0	8500
0270 1100	110	435	47,5	172,0	8500
0270 1150	115	435	47,5	172,0	8500
0270 1200	120	480	54,0	182,0	10000
0270 1250	125*	480	54,0	182,0	10000
0270 1300	130	520	58,0	202,0	13000
0270 1350	135	520	58,0	202,0	13000
0270 1400	140*	520	58,0	202,0	13000
0270 1450	145	580	64,0	228,0	18000
0270 1500	150	580	64,0	228,0	18000
0270 1550	155	580	64,0	228,0	18000
0270 1600	160*	580	64,0	228,0	18000

Art. Code	mm	l mm	a mm	b mm	g	
0270 1650	165	650	70,0	265,0	25000	1
0270 1700	170	650	70,0	265,0	25000	1
0270 1750	175*	650	70,0	265,0	25000	1
0270 1800	180*	650	70,0	265,0	24600	1
0270 1850	185*	700	75,0	290,0	33000	1
0270 1900	190*	700	75,0	290,0	32600	1
0270 1950	195*	700	75,0	290,0	31800	1
0270 2000	200*	700	75,0	290,0	32000	1
0270 2050	205*	750	80,0	320,0	40500	1
0270 2100	210*	750	80,0	320,0	39500	1
0270 2150	215*	750	80,0	320,0	39000	1
0270 2200	220*	750	80,0	320,0	37400	1
0270 2250	225*	750	80,0	320,0	36400	1
0270 2300	230*	750	80,0	320,0	35400	1

* Made to order, no general stock size

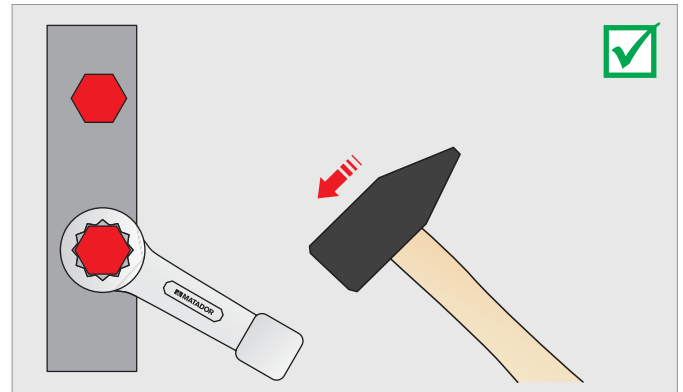

■ Slogging Ring Ended Spanners (AF)

- Tried and tested MATADOR classic
 - For tightening and loosening of big screw joints, e.g. in heavy industry, shipbuilding, plant construction, etc.
 - Ideal for the use with club hammer or air hammer
 - Precisely drop-forged
 - Very high impact strength
 - Up to 435 mm made of Chrome Vanadium steel 31 CrV 3, from 480 mm made of C 35
 - With zinc-plated surface for durable rust protection - not only sandblasted / oiled
- Standards: DIN 7444 (except for special sizes *)
 - Material: 31 CrV 3 / C 35
 - Surface treatment: Zinc-plated

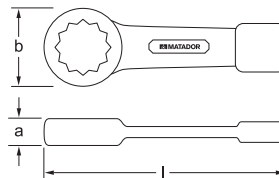

Art. Code	* AF	l mm	a mm	b mm	g	
0270 8002	1*	160	15,0	42,5	1640	1
0270 8003	1.1/16*	185	15,5	48,5	1650	1
0270 8004	1.1/8*	185	15,5	48,5	1640	1
0270 8005	1.3/16*	190	16,5	52,5	1640	1
0270 8006	1.1/4*	190	16,5	52,5	1640	1
0270 8007	1.5/16*	195	16,5	54,0	2150	1
0270 8008	1.3/8*	195	16,5	54,0	2300	1
0270 8009	1.7/16*	205	19,5	60,0	2150	1
0270 8010	1.1/2*	205	19,5	60,0	2150	1
0270 8011	1.9/16*	230	20,0	66,0	2150	1
0270 8012	1.5/8*	225	20,5	66,0	2600	1
0270 8013	1.11/16*	225	20,5	66,0	2950	1
0270 8014	1.3/4*	225	20,5	66,0	2950	1
0270 8015	1.13/16*	240	22,5	75,0	2950	1
0270 8016	1.7/8*	240	22,5	75,0	2800	1
0270 8017	1.15/16*	255	24,0	80,0	3350	1

Art. Code	* AF	l mm	a mm	b mm	g	
0270 8018	2*	250	23,5	80,0	2800	1
0270 8019	2.1/16*	250	23,5	80,0	2800	1
0270 8020	2.1/8*	250	23,5	80,0	2800	1
0270 8021	2.3/16*	270	25,0	87,5	4000	1
0270 8022	2.1/4*	270	25,0	87,5	3800	1
0270 8023	2.5/16*	280	26,0	93,0	4000	1
0270 8024	2.3/8*	270	26,0	93,5	4000	1
0270 8025	2.7/16*	270	26,0	93,5	4000	1
0270 8028	2.5/8*	290	29,0	101,0	3850	1
0270 8030	2.3/4*	320	32,5	109,5	3850	1
0270 8032	2.7/8*	330	33,0	110,0	5700	1
0270 8048	3.7/8*	420	45,0	155,0	6500	1

* Made to order, no general stock size

MATADOR Heavy Duty Ring Spanners.

Long lever - large impact.

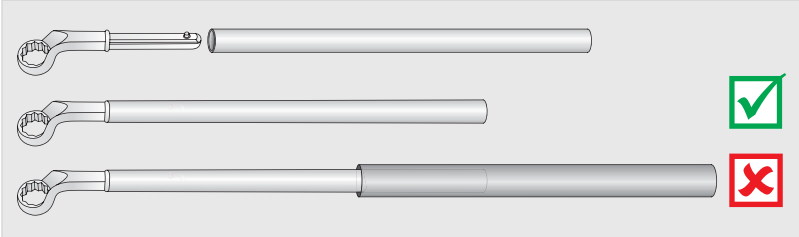

■ Heavy Duty Ring Spanners (MM)



- Tried and tested MATADOR classic
- For tightening and loosening of big screw joints, e.g. in heavy industry, shipbuilding, plant construction, etc.
- Precisely drop-forged
- Very high impact strength
- Very high power together with extension pipe
- With zinc-plated surface for durable rust protection

- Material: 31 CrV 3
- Surface: Matt chrome finish

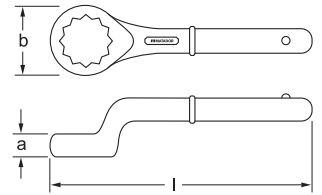

Art. Code	mm	l mm	a mm	b mm	g	
0280 0240	24	180	17,0	38,0	350	1
0280 0260	26*	190	17,0	42,0	430	1
0280 0270	27	190	17,4	42,0	400	1
0280 0300	30	200	18,4	47,0	450	1
0280 0320	32	235	18,4	50,0	550	1
0280 0330	33*	235	18,4	50,0	700	1
0280 0360	36	245	20,0	55,0	650	1
0280 0380	38	250	21,0	55,0	840	1
0280 0420	42*	265	22,0	61,5	1000	1
0280 0450	45*	280	23,0	68,5	1300	1
0280 0460	46	280	23,0	68,5	1050	1
0280 0480	48*	290	25,5	75,0	1450	1
0280 0500	50	290	25,5	75,0	1150	1
0280 0550	55	300	28,0	80,0	1400	1
0280 0600	60	345	30,5	89,0	2100	1

Art. Code	mm	l mm	a mm	b mm	g	
0280 0650	65	355	33,0	97,0	2300	1
0280 0700	70	365	35,5	104,0	2600	1
0280 0750	75	375	38,0	109,0	3000	1
0280 0800	80	385	40,5	124,0	3450	1
0280 0850	85	385	40,5	124,0	3800	1
0280 0900	90	410	45,0	140,0	4875	1
0280 0950	95	410	45,0	140,0	4565	1
0280 1050	105*	415	45,0	144,0	4600	1

* Made to order, no general stock size

The perfect leverage effect.

Long lever - large impact.

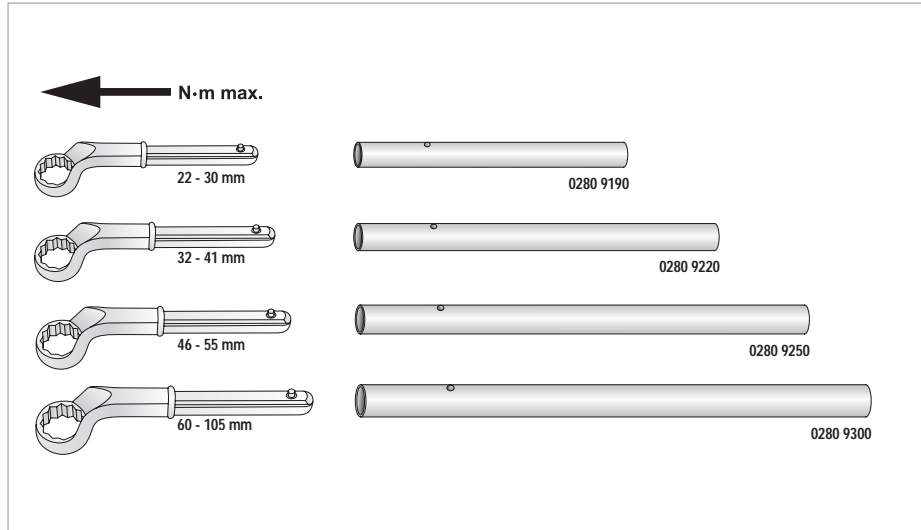

The perfect leverage effect.

Very convenient: The perfectly fitting extension pipes for MATADOR Heavy Duty Ring Spanners.

The increased lever transmission makes it possible to move big screws manually with relatively little effort. The locking pin allows quick assembly and disassembly.

Available in four sizes up to 105 mm. Special sizes on request.



■ Extension Pipes for Heavy Duty Ring Spanners

- For extension of the lever arm and increased force action
- With hole for safe locking and unlocking
- Material: 31 CrV 3
- Surface treatment: Zinc-plated

Art. Code	mm	mm	" AF	l mm	g	
0280 9190	19	22 - 30	7/8 - 1.3/16	460	600	1
0280 9220	22	32 - 41	1.1/4 - 1.11/16	610	1150	1
0280 9250	25	46 - 55	1.3/4 - 2.1/4	760	2150	1
0280 9300	30	60 - 105	2.3/8 - 4.1/8	860	2850	1



The specials from MATADOR.

For confined spaces and special applications.

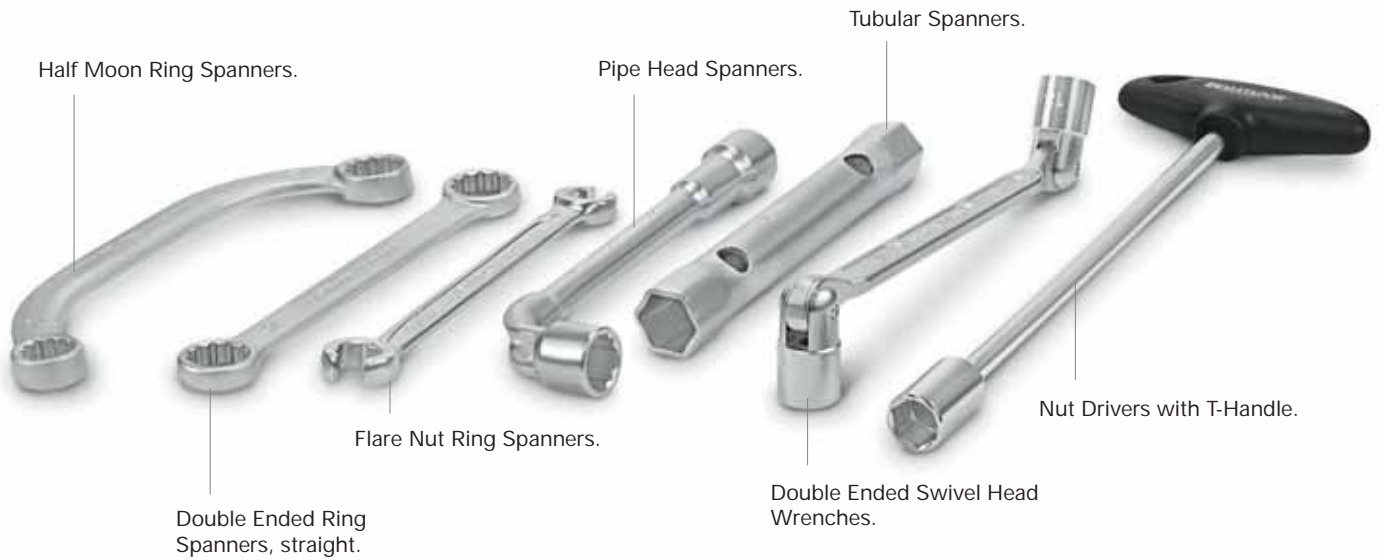

Half Moon Ring Spanners



- Double ended ring spanners with curved shaft and extra thin-walled rings for work in confined spaces (e. g. car engine block, carburettor / starter, electric generator etc.)
 - High-grade, durable industrial quality
 - Good grip thanks to matt chrome-plated surface, also with oily hands
- Material: Chrome Vanadium
 - Surface: Matt chrome finish

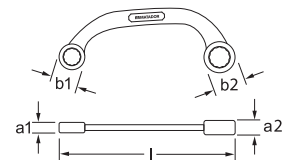
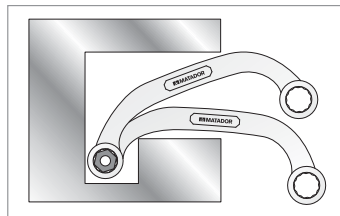

Art. Code	mm	l mm	a1 mm	a2 mm	b1 mm	b2 mm	g	
0188 1012	10 x 12	150	7,0	7,0	17,0	20,0	55	10
0188 1113	11 x 13	150	7,0	7,0	17,0	20,0	55	10
0188 1315	13 x 15	185	9,0	9,0	21,5	26,0	110	10
0188 1417	14 x 17	185	9,0	9,0	21,5	26,0	110	10
0188 1517	15 x 17	185	9,0	9,0	21,5	26,0	100	10
0188 1618	16 x 18	185	9,0	9,0	21,5	26,0	100	10
0188 1922	19 x 22	230	11,0	11,0	29,0	33,0	195	10

Double Ended Ring Spanners, straight

- Straight double ended ring spanners with extra-thin walled rings for work in confined spaces
- High-grade, durable industrial quality
- Good grip thanks to matt chrome-plated surface, also with oily hands
- Heads grinded fully automatically
- Standards: DIN 837 Form B ISO 3318 / 1085
- Material: Chrome Vanadium
- Surface: Matt chrome finish

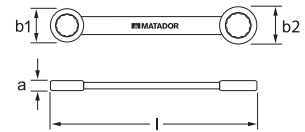

Art. Code	mm	l mm	a mm	b1 mm	b2 mm	g	
0220 0607	6 x 7	100	4,5	10,0	11,5	14	10
0220 0809	8 x 9	115	5,2	13,0	14,5	24	10
0220 0810	8 x 10	115	5,2	13,0	16,0	22	10
0220 1011	10 x 11	130	5,8	16,0	17,0	34	10
0220 1213	12 x 13	150	6,4	19,0	20,5	49	10
0220 1315	13 x 15	160	7,2	20,5	23,0	64	10
0220 1317	13 x 17	165	7,8	20,5	25,5	74	10
0220 1415	14 x 15	160	7,2	21,5	23,0	64	10
0220 1617	16 x 17	170	7,8	24,5	25,5	84	10
0220 1719	17 x 19	185	8,5	25,5	28,0	98	10
0220 1819	18 x 19	185	8,5	27,0	28,0	106	10
0220 2022	20 x 22	210	9,4	29,5	32,5	134	10
0220 2123	21 x 23	230	10,0	30,5	33,5	171	10
0220 2224	22 x 24	230	10,0	32,5	35,5	184	10
0220 2427	24 x 27	260	10,8	35,5	39,0	249	10
0220 2528	25 x 28	290	11,6	36,5	41,0	273	10
0220 3032	30 x 32	320	12,6	43,5	46,0	399	10



- Set in PP-Box

Art. Code	g
0220 9080 8 MM	430
Content: 0220 6 x 7 - 8 x 9 - 10 x 11 - 12 x 13 - 14 x 15 - 16 x 17 - 18 x 19 - 20 x 22 mm	
0220 9120 12 MM	1260
Content: 0220 6 x 7 - 8 x 9 - 10 x 11 - 12 x 13 - 14 x 15 - 16 x 17 - 18 x 19 - 20 x 22 - 21 x 23 - 24 x 27 - 25 x 28 - 30 x 32 mm	



Double Ended Ring Spanners, TORX®

- as above, but TORX® profile

Art. Code	E	l mm	a1 mm	a2 mm	b1 mm	b2 mm	g		
0221 0608	6 x 8	110	4,6	5,6	9,2	11,2	20	10	
0221 1012	10 x 12	140	6,5	7,8	14,4	16,7	31	10	
0221 1418	14 x 18	180	8,2	9,8	17,2	21,2	75	10	
0221 2024	20 x 24	225	11,0	13,0	24,8	28,7	158	10	
0222 1012	10 x 12	angled	140	6,5	7,8	14,4	16,7	31	10

- Set in carton box

Art. Code	g
0221 9080 4 MM	430
Content: 0221 6 x 8 - 10 x 12 - 14 x 18 - 20 x 24 mm	



Flare Nut Ring Spanners, open



- For cap nuts at pipelines, ideal for brake lines
 - Drop-forged with reinforced ring
 - Jaws slotted and 15° offset from shaft
 - Up to size 13 x 14 mm with hexagon profile, from size 14 x 17 mm with double hexagon profile
- Standards: DIN 3118
 - Material: Chrome Vanadium
 - Surface: Matt chrome finish

Art. Code	mm	l mm	t1 mm	t2 mm	a1 mm	a2 mm	b1 mm	b2 mm	g
0251 0810	8 x 10	145	6,0	7,0	7,0	8,5	18,0	20,0	47
0251 1011	10 x 11	152	7,0	8,5	8,5	9,0	20,0	22,0	60
0251 1012	10 x 12	152	7,0	9,0	8,5	9,0	20,0	22,6	60
0251 1113	11 x 13	165	8,5	10,0	9,0	10,5	22,0	25,0	78
0251 1314	13 x 14	178	10,0	11,0	9,5	11,0	24,0	27,4	120
0251 1417	14 x 17	196	11,0	14,0	11,0	12,0	27,4	30,0	145
0251 1719	17 x 19	210	14,0	15,0	12,0	14,0	30,0	32,5	180
0251 1922	19 x 22	233	15,0	17,0	14,0	16,0	32,5	38,0	240
0251 2224	22 x 24	252	17,0	18,0	16,0	17,0	38,0	41,0	300
0251 2427	24 x 27	265	18,0	20,0	17,0	18,0	41,0	45,0	350
0251 2736	27 x 36	285	20,0	22,0	18,0	25,0	45,0	58,0	470
0251 3032	30 x 32	285	22,0	24,0	21,0	23,0	48,5	51,0	470
0251 3641	36 x 41	350	27,0	32,0	25,0	27,0	58,0	65,0	820

- Tried and tested assortment of open flare nut ring spanners
- All important sizes in one set
- Set in practical, transparent polypropylene box: robust packaging, stackable and easy to stock, reclosable, reusable and with hanging hole for tool panels

Art. Code	g
0251 9050 5 MM	550

Content: 8 x 10 - 10 x 12 - 11 x 13 - 14 x 17 - 19 x 22 mm

Flare Nut Ring Spanners, open



- Straight, reinforced type, especially for screwed connections on brake lines
- Straight slotted, with hexagon ring
- Material: Chrome Vanadium
- Surface: Matt chrome finish

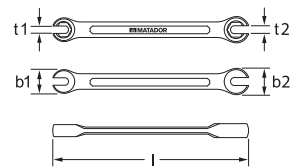

Art. Code	mm	l mm	t1 mm	t2 mm	b1 mm	b2 mm	g
0250 0001	10 x 11	150	7,0	8,5	20,5	22,3	170

- Offset, reinforced type, especially for screwed connections on brake lines
- Straight slotted, with hexagon ring
- Material: Chrome Vanadium
- Surface: Matt chrome finish

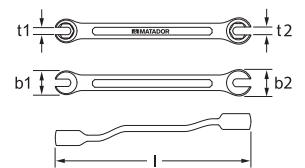

Art. Code	mm	l mm	t1 mm	t2 mm	b1 mm	b2 mm	g
0250 0002	10 x 11	150	7,0	8,5	20,5	22,3	170



Tubular Box Spanners

- For numerous fields of application, ideal for stud bolts, deep-set nuts and spark plugs
- With hollow shaft
- With borehole for tommy bars (Art. Code 342)
- Standards: DIN 896 Form B
ISO 2236 / 1085

- Material: C35 hardened
- Surface: Matt chrome finish

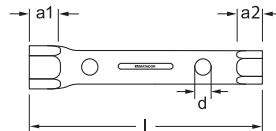

Art. Code	mm	d mm	l mm	a1 mm	a2 mm	g
0380 0607	6 x 7	5	105	6,0	6,5	80
0380 0809	8 x 9	6	105	7,0	7,5	85
0380 0810	8 x 10	6	120	7,0	8,0	105
0380 1011	10 x 11	6	140	8,0	8,5	115
0380 1213	12 x 13	8	140	9,5	10,0	145
0380 1315	13 x 15	8	140	10,0	11,5	170
0380 1415	14 x 15	8	140	10,5	11,5	185
0380 1617	16 x 17	10	150	12,0	12,5	215
0380 1719	17 x 19	12	155	12,5	15,5	240
0380 1819	18 x 19	12	155	13,5	15,5	275
0380 1821	18 x 21	12	155	13,5	16,0	345
0380 2022	20 x 22	12	165	16,0	16,5	385
0380 2123	21 x 23	14	165	16,0	18,0	490
0380 2427	24 x 27	14	180	20,0	22,0	550
0380 2528	25 x 28	16	195	20,0	22,0	550
0380 3032	30 x 32	16	195	23,0	27,0	715
0380 3236	32 x 36	18	215	27,0	28,0	750
0380 3641	36 x 41	18	215	28,0	31,0	885
0380 4146	41 x 46	20	235	31,0	35,0	890
0380 4650	46 x 50	20	235	35,0	37,0	890

- Tried and tested assortments of tubular box spanners
- All important sizes in one set
- In carton box



Art. Code	Content	g
0380 9080	0380 6 x 7 - 8 x 9 - 10 x 11 - 12 x 13 - 14 x 15 - 16 x 17 - 18 x 19 - 20 x 22 mm	850
0380 9120	0380 6 x 7 - 8 x 9 - 10 x 11 - 12 x 13 - 14 x 15 - 16 x 17 - 18 x 19 - 20 x 22 - 21 x 23 - 24 x 27 - 25 x 28 - 30 x 32 mm	2100

Tommy Bar

- 5 steps tommy bar for pipe head spanners (Art. Code 320), tubular box spanners (Art. Code 380) etc.
- For boreholes with a diameter of 5, 6, 8, 10 and 12 mm
- Suitable as T-handle

- Material: Chrome Vanadium
- Surface: Matt chrome finish

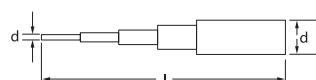

Art. Code	d mm	l mm	g
0342 0250	5 - 6 - 8 - 10 - 12	200	230

Hexagon Nut Drivers



- With 2-component handle with hard zone for quick fastening and soft zone for comfortable fine adjustment
- Especially ergonomic handle
- With hanging hole

- Standards: DIN 3125
- Blade Material: Chrome Vanadium
- Blade Surface: Matt chrome finish

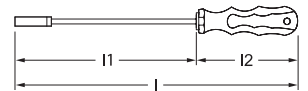

Art. Code	mm	M	l mm	l1 mm	l2 mm	g	
0670 2050	5	2,5	235	125	110	67	10
0670 2060	6	3,5	235	125	110	69	10
0670 2070	7	4,0	235	125	110	100	10
0670 2080	8	5,0	235	125	110	102	10
0670 2100	10	6,0	235	125	110	106	10

Hexagon Nut Drivers, flexible



- With flexible shaft
- For hose clamps and confined spaces
- With 2-component handle with hard zone for quick fastening and soft zone for comfortable fine adjustment
- Especially ergonomic handle
- With hanging hole

- Standards: DIN 3125
- Blade Material: Chrome Vanadium
- Blade Surface: Matt chrome finish

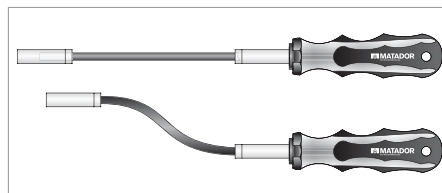

Art. Code	mm	M	l mm	l1 mm	l2 mm	g	
0670 0050	5	2,5	410	150	260	129	10
0670 0060	6	3,5	410	150	260	131	10
0670 0070	7	4	410	150	260	132	10
0670 0080	8	5	410	150	260	133	10
0670 0100	10	6	410	150	260	140	10

Nut Drivers with T-Handle

- Extra long design
- With ergonomically designed T-handle made of highly impact-resistant special plastic
- With hanging hole
- Chamfered edges
- Blade Material: Chrome Vanadium
- Blade Surface: Nickel-plated

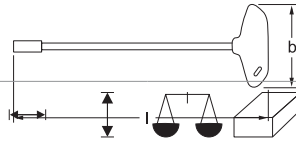

Art. Code	mm	M	l mm	b mm	g		
0671 0055	5,5	3	230	90	123	10	
0671 0060	6	3,5	230	90	125	10	
0671 0070	7	4	230	90	125	10	
0671 0080	8	5	230	90	138	10	
0671 0090	9		230	90	140	10	
0671 0100	10	6	230	90	172	10	
0671 0110	11	7	230	90	170	10	
0671 0120	12	(8)	230	90	174	10	
0671 0130	13	8	230	90	177	10	
0671 0140	14		230	90	185	10	



Wheel Nut Wrenches

- With deep head for deep-set wheel nuts
- Hardness and torque values as per DIN 899
- Especially high corrosion resistance thanks to KTL coating (cathaphoretic dip paint)
- Material: Chrome Vanadium
- Surface: KTL coating

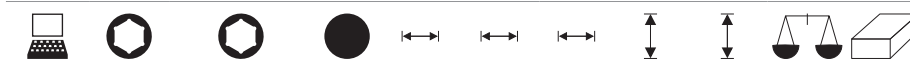
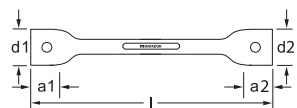

Art. Code	mm	AF	mm	l mm	a1 mm	a2 mm	d1 mm	d2 mm	g	
0340 2427	24 x 27	15/16 x 1.1/16	18	400	34,5	34,5	37	41	80	10
0340 2730	27 x 30	1.1/16 x 1.3/16	18	400	34,5	34,5	41	45	85	10
0340 2732	27 x 32	1.1/16 x 1.1/4	18	400	34,5	34,5	41	47	105	10
0340 2833	28 x 33		18	400	34,5	34,5	42	48	115	5
0340 3032	30 x 32	1.3/16 x 1.1/4	18	400	34,5	34,5	45	47	145	5
0340 3233	32 x 33		18	400	34,5	34,5	47	48	170	5



Tommy Bar

- Straight tommy bar
- Surface: KTL coating



Art. Code	mm	l mm	g
0342 0600	18	600	1190





Sockets and accessories.

Be a MATADOR.





Content Sockets / accessories.

Page Article group

6,3 	Sockets and accessories 6,3 (1/4)
46	Reversible Ratchet
1/4	47 Reversible Ratchet Z90
48	2in1 Spinner Handle
49	Sliding T-Handle
49	Extensions
49	Universal Joint
49	Spinner Handle
50	T-Handle Extension
50	Converter
50	Adapter
51	Sockets
51	Sockets „Mini“, Set
52	Sockets, long type
52	Sockets (TORX®)
52	Sockets „Mini“, Set
53	Screwdriver Bit Sockets (Slotted)
53	Screwdriver Bit Sockets (PH)
53	Screwdriver Bit Sockets (PZ)
54	Screwdriver Bit Sockets (Hex)
54	Screwdriver Bit Sockets „Mini“, Set
54	Screwdriver Bit Sockets (TORX®)
55	Screwdriver Bit Sockets „Mini“, Set
55	Screwdriver Bit Sockets (TORX® with pilot)
55	Socket Rail
56	Socket Sets Classic 6.3 (1/4)
57	Socket Sets Pro 6.3 (1/4)
10 	Sockets and accessories 10 (3/8)
3/8	58 Reversible Ratchet Z90
59	Sliding T-Handle
59	Extensions
59	T-Handle Extension
60	Universal Joint
60	Reducer
60	Converter
60	Bit Adapter
61	Sockets (MM)
62	Sockets (long type)
62	Sockets (TORX®)
62	Screwdriver Bit Sockets (Slotted)
63	Screwdriver Bit Sockets (PH)
63	Screwdriver Bit Sockets (Hex)
63	Screwdriver Bit Sockets (XZN)
64	Screwdriver Bit Sockets (TORX®)
64	Screwdriver Bit Sockets Set (TORX®)

Page Article group

65	Socket Sets 10 (3/8)
12,5 	Sockets and accessories 12,5 (1/2)
1/2	66 Reversible Ratchet Z90
67	Push-Through Ratchet
68	Sliding T-Handle
68	Extensions
68	Extensions (Wobble Type)
69	Universal Joint
69	Speed Brace
69	Swivel Handle
69	T-Handle Extension
70	Reducer
70	Converter
70	Bit Adapters
71	Sockets (MM)
72	Sockets (AF)
73	Sockets, long type
73	Sockets (TORX®)
74	Screwdriver Bit Sockets (Hex)
74	Screwdriver Bit Sockets Set (Hex)
75	Screwdriver Bit Sockets (XZN)
75	Screwdriver Bit Sockets Set (XZN)
76	Screwdriver Bit Sockets (RIBE®)
76	Screwdriver Bit Sockets (TORX®)
77	Screwdriver Bit Sockets Set (TORX®)
77	Screwdriver Bit Sockets (TORX® with pilot)
77	Screwdriver Bit Sockets Set (TORX® with pilot)
78	Socket Sets 12.5 (1/2)
78	Socket Sets PRO 6.3 (1/4) / 12.5 (1/2)
79	Socket Sets 12.5 (1/2), long type
79	Screwdriver Sockets Set (TORX®)
20 	Sockets and accessories 20 (3/4)
3/4	80 Reversible Ratchet (72 T)
80	Push-Through Ratchet
81	Sliding T-Handle
81	Extensions
81	Universal Joint
81	Reducer
82	Converter
82	Sockets
83	Socket Sets 20 (3/4)

Page Article group

25 	Sockets and accessories 25 (1)
1	84 Reversible Ratchet
84	Sliding T-Handle
84	Extensions
84	Reducer
85	Sockets (MM)
85	Socket Set 25 (1)
85	Construction ratchet



MATADOR drive technology. Benefit from experience.

In the beginning there was only an idea.



MATADOR's first reversible ratchet made in 1924, patented in Germany.



2018 model of the MATADOR reversible ratchet.



Why recessed switch lever?

MATADOR reversible ratchets are basically equipped with recessed switch levers.

In comprehensive application studies we found that the most common cause of defect is a torn-off switch lever. In daily use in workshops reversible ratchets are often simply thrown into the tool box or even misused as hammers. Yet a light tap on a protruding lever can cause it to tear off and render it impossible to continue work.

Since 1900 we think about drive technology.

Often, less is more.

The intrinsic values are what counts.

As one of the first manufacturers in Europe already in 1924 MATADOR presented its first reversible ratchet which was patented in Germany.

It is not our objective to offer the most extensive range of ratchets in the market and to sell "old wine in new bottles".

Besides a proper use the lifetime of a ratchet is substantially determined by the quality of the components.

In the course of the following years a comprehensive range of operating tools had been developed.

Instead we concentrate on our core competences and have only those ratchets in our range that are really needed in practice and that meet our strict requirements in terms of quality.

For instance, the MATADOR reversible ratchet with 12.5 mm (½") drive is made of 12 individual components that are precisely matched to each other. Especially the toothed ratchet wheel, the pawl made of heavy duty steel for fixing the wheel as well as the lever for switching from clockwise to anti-clockwise operation

Nowadays, CNC-controlled processes allow the production of top quality ratchets. However, their core function has not changed significantly. Back then as well as today ratchets help tightening or loosening screwed connections quickly by hand.

No toys but solid technology for professional users at an appropriate price/performance ratio.

are parts that are exposed to heavy load. The ideal composition of the used material as well as a perfect machining are of great importance.

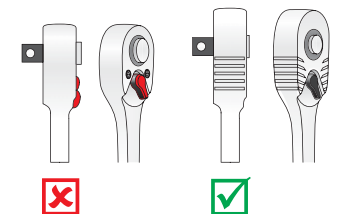

That is why MATADOR countersinks the switch levers into the ratchet body creating an even and invulnerable surface.

















A small detail with high effect.

All ratchets at a glance.

Get back to basics.

From 6.3 (1/4") up to 25 (1") drive. Extremely short for confined spaces or extremely long for high torque transmission. Or extendible. Or swivelling. Normal-toothed or fine-toothed with 72 teeth for only 5° swivel angle. With lever or push-through-technology.

You don't find what you need? Please contact us.

			6.3 mm 1/4	10 mm 3/8	12.5 mm 1/2	20 mm 3/4	25 mm 1
	 Reversible Ratchet, fine-toothed	2061 0001	--	--	--	--	--
	 Reversible Ratchet, fine-toothed	2061 0090	--	--	--	--	--
	 Reversible Ratchet, fine-toothed	--	3061 0090	--	--	--	--
	 Reversible Ratchet, fine-toothed	--	--	4061 0090	--	--	--
	 Push-Through Ratchet, normal-toothed	--	--	4062 0001	--	--	--
	 Reversible Ratchet, fine-toothed	--	--	--	5060 0001	--	--
	 Push-Through Ratchet, normal-toothed	--	--	--	5062 0001	--	--
	 Reversible Ratchet, fine-toothed	--	--	--	--	6060 0001	--

How much torque do you need? Minimum torque requirements according to DIN 3122 for reversible ratchets:

		6.3 mm 1/4	10 mm 3/8	12.5 mm 1/2	20 mm 3/4	25 mm 1
	up to a max. swivel angle of 20°	62 N-m	202 N-m	--	--	--
	up to a max. swivel angle of 15°	--	--	512 N-m	1412 N-m	2515 N-m

MATADOR Sockets with Super-Chrom and SmartDrive².

Our range of sockets and screwdriver bit sockets for professional use.

Super-Chrom coating outside and inside - for permanence and durability.



From 6.3 (1/4") to 20 (3/4") with SmartDrive².



All tools are automatically stamped, not only lasered.



From 10 (3/8") to 12.5 (1/2") with cross knurling for quick manual operation (also with oily hands).

4 deep milled ball grooves for secure hold.

Higher torque values thanks to SmartDrive.

As one of the first tool manufacturers MATADOR introduced a special flank drive profile ("SmartDrive") more than 10 years ago.

Sockets with MATADOR Smart-Drive profile distribute the power to the screw head flanks, not to the edges. As a result MATADOR sockets work on about double the contact surface as conventional sockets.

The advantages:

- Optimized traction, even on worn screws
- Higher torque values
- Ideal protection of the screws

All MATADOR sockets with square drives from 6.3 (1/4") up to 20 (3/4") are supplied with SmartDrive.

And what's more: SmartDrive².

The perfect add-on to SmartDrive is SmartDrive².

Also on the drive end of a socket enormous power is applied and the optimal traction between the outer square of the operating tool and the inner square of the socket is highly important.

That's why the inner squares of the MATADOR sockets are also provided with a SmartDrive profile: The edges of the outer square will be protected thanks to the notches. Slightly convex flanks transfer the power to the plane surface.

MATADOR SmartDrive² - you should not be content with less.

MATADOR SuperChrom.

Generally quality hand tools undergo a fully galvanic treatment, i.e. they are first nickel-plated and then chrome-plated.

Through the (yellowly shimmering) nickel coating the tools get rust protection and through chrome which is applied afterwards they receive their silvery shiny appearance.

MATADOR SuperChrom goes one step further: Through especially intense grinding the tools get a very smooth surface. Afterwards they will be finished optimally with a very resistant and thick nickel-chrome-plating - of course chrome VI free and environmentally friendly.

Inner values combined with a valuable appearance.

In the result SuperChrom does not only look much more valuable but it also significantly improves the resistance to external impacts.

Chrome spalling due to heavy duty application, scratches on the surface etc. and thus potential patches of rust are things of the past.

Please test yourself and compare MATADOR SuperChrom tools with conventionally chrome-plated tools - you will be impressed.

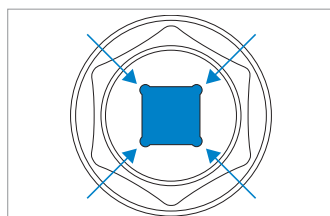
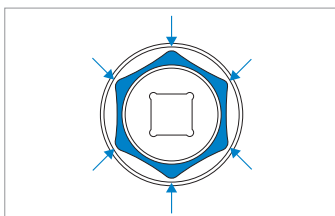















































Alle Steckschlüssel auf einen Blick.

Von der Feinmechanik bis hin zur Schwerindustrie.

From 6.3 (1/4") up to 25 (1") drive. Six point. Double six point. Millimeter. Inch. Short type. Long type. With bits for slotted screws. For cross-slotted screws. For hexagon socket screws. For XZN. For RIBE®. For TORX®. With drive for bits from 6.3 (1/4") to 11 (7/16").

You don't find what you need? Please contact us.

						
	 Sockets, six point	2075 4 – 14 (1/8 – 9/16)	3075 6 – 22 (1/4 – 5/16)	4075 8 – 36 (3/8 – 1.1/4)	5075 19 – 60 (7/8 – 2.1/4)	-
	 Sockets, double six point	-	3075 6 – 22 (11/32 – 7/8)	4075 10 – 36 (3/8 – 1.1/4)	5075 19 – 60	6075 36 – 80
	 Sockets, long type, six point	2081 4 – 14	3081 8 – 22	4081 10 – 32	-	-
	 Sockets, long type, double six point	-	-	4081 10 – 32	-	-
	 Sockets, outside TORX®	2090 E4 – E11	3090 E8 – E14	4090 E10 – E24	-	-
	 Screwdriver Bit Sockets, for slotted screws	2076 4 – 7	3076 7 – 9	4076 8 – 12	-	-
	 Screwdriver Bit Sockets, for cross-slotted screws PH	2077 PH 1 – 3	3077 PH 1 – 3	4077 PH 2 – 4	-	-
	 Screwdriver Bit Sockets, for cross-slotted screws PZ	2077 PZ 1 – 3	-	-	-	-
	 Screwdriver Bit Sockets, for hexagon socket screws	2078 3 – 10	3078 4 – 10	4078 4 – 19 (3/6 – 9/16)	-	-
	 Screwdriver Bit Sockets, for multi-point screws XZN	-	3079 M5 – M10	4079 M5 – M16	-	-
	 Screwdriver Bit Sockets, for multi-spline screws RIBE®	-	-	4080 M5 – M16	-	-
	 Screwdriver Bit Sockets, for recessed TORX® screws	2092 T6 – T40	3092 T15 – T50	4092 T20 – T80	-	-
	 Screwdriver Bit Sockets, for recessed TORX® screws with pin	2093 TR8 – TR40	-	4093 TR20 – TR80	-	-
	 Reducers	-	3082 0001	-	-	-
	 Reducers and Converters	2083 0001	-	4082 0001	-	-
	 Reducers and Converters	-	3083 0001	-	5082 0001	-
	 Reducers and Converters	-	-	4083 0001	-	6082 0001
	 Reducers and Converters	-	-	-	5083 0001	-
	 Bit Adapters	2084 0001 2084 0002	3084 0001	4084 0001	-	-
	 Bit Adapters	-	-	4084 0002	-	-
	 Bit Adapters	-	-	4084 0003	-	-

The MATADOR reversible ratchet in 6.3 (1/4").

Small, handy and compact.

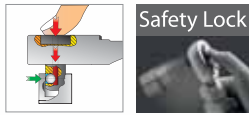

Safety Lock

With safety lock and quick-release function.



Ergonomic handle.

Recessed lever for clockwise and anti-clockwise movement.



Fine-toothed with 72 teeth for only 56° swivel angle.

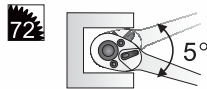

■ Reversible Ratchet



- Small ratchet head for confined spaces
- With safety lock and quick-release function
- With lever
- Fine-toothed with 72 teeth
- For hand-operated sockets and adapters
- With square drive as per DIN 3120 - C 6.3 / ISO 1174

- Standards: DIN 3122 / ISO 3315
- Material: Chrome Vanadium
- Surface: Matt chrome finish

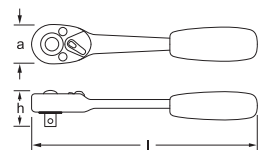

Art. Code	mm	"	l mm	a mm	h mm	g	
2061 0090	6,3	1/4	140	25	23	110	10
2061 0010	Repair Kit					30	1

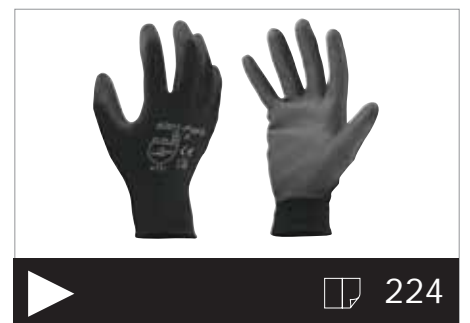
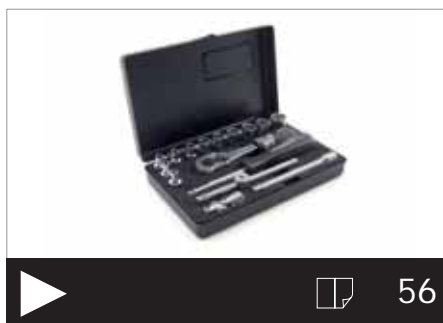
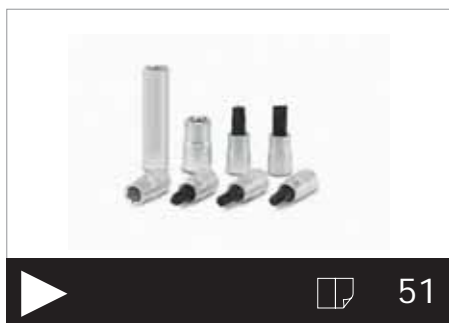

The new MATADOR Z90 reversible ratchet in 6.3 (1/4").
More teeth. More power. More grip. More applications. More design.

25%

reduced angle (only 4°) compared to standard fine-toothed ratchets thanks to an innovative 90-teeth technique. Still ready for working even when it gets really tight.

4°

50%

more torque than requested in the DIN standard (e.g. 12.5 mm (1/2") > 750 N·m). Still loosens screws when others have long given up.

max.

ergonomics thanks to multi-component handle, better than standard 1- or 2-component handles. Optimally adapted, spherical shape.



6.3 mm
1/4

Reversible Ratchet

- Extremely robust square shank made of Chrome Vanadium steel for high resilience in every situation
- Push-button lock for a safe connection between ratchet and socket
- Recessed, flat lever for quick change of direction
- Fine-toothed with 90 teeth, only 4° swivel angle
- For hand-operated sockets and adapters
- Practical hanging loop to secure the ratchet during construction work or to hang on a tools panel

- Standards: DIN 3122 / ISO 3315
- Material: Chrome Vanadium
- Surface: Matt chrome finish

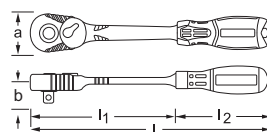

Art. Code	mm	"	l mm	l1 mm	l2 mm	a mm	b mm	g	
2061 0090	6,3	1/4	125	70	55	23,5	24,7	112	10
2061 0099	Repair Kit							30	1



MATADOR 2in1 Spinner Handle.

The innovative multiscrewdriver.



multi-component handle. Optimally adapted, spherical shape.

Bayonet mount for bit and square drive.



With hexagon socket for bits.



With square drive for sockets.



Ergonomic and comfortable thumb rest.



Practical hanging loop to secure the handle during construction work or to hang on a tools panel.

Spinner Handle 2in1



- Innovative spinner handle that can be used as a multiscrewdriver
- Patented spinner handle with bayonet mount for bit and square drive
- Ergonomic multi-component handle

- Standards: DIN 3122 / ISO 3315
- Material: Chrome Vanadium
- Surface: Matt chrome finish

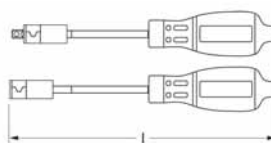

Art. Code	mm	"	l mm	g	
2073 0090	6,3	1/4	165	90	10

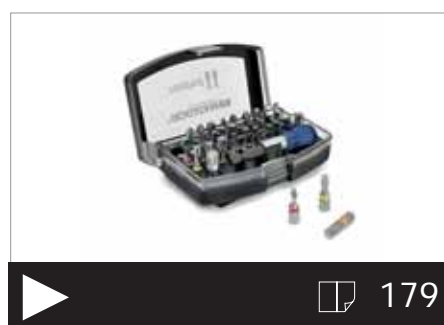
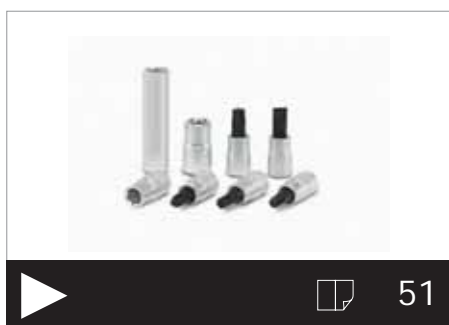

Sliding T-Handle

1/4 6.3 mm

- Can be used as T-Handle, with sliding square drive
- With ball locking device
- For hand-operated sockets and adapters
- With square drive as per DIN 3120 - A 6.3 / ISO 1174

- Standards: DIN 3122 / ISO 3315
- Material: Chrome Vanadium
- Surface: Super-Chrom

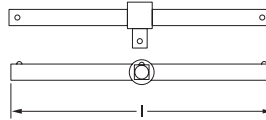

Art. Code	mm	"	l mm	g	
2064 0001	6,3	1/4	115	42	10

Extensions

1/4 6.3 mm 1/4 6.3 mm

- With ball locking device
- For hand-operated sockets and adapters
- With square drive as per DIN 3120 - A 6.3 and C 6.3 / ISO 1174
- Standards: DIN 3123 / ISO 3315

- Material: Chrome Vanadium
- Surface: Super-Chrom



Art. Code	mm	"	mm	"	d mm	l mm	l' "	g	
2065 0001	6,3	1/4	6,3	1/4	12	50	2	20	10
2065 0002	6,3	1/4	6,3	1/4	12	100	4	40	10

Universal Joint

1/4 6.3 mm 1/4 6.3 mm

- With ball locking device
- For hand-operated sockets and adapters
- With square drive as per DIN 3120 - A 6.3 and C 6.3 / ISO 1174
- Standards: DIN 3123 / ISO 3316

- Material: Chrome Vanadium
- Surface: Super-Chrom

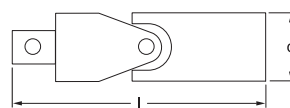

Art. Code	mm	"	mm	"	d mm	l mm	g	
2068 0001	6,3	1/4	6,3	1/4	14	38	27	10

Spinner Handle

1/4 6.3 mm

- With ball locking device
- For hand-operated sockets and adapters
- With square drive as per DIN 3120 - A 6.3 / ISO 1174

- Standards: DIN 3122 / ISO 3315
- Material: Chrome Vanadium
- Surface: Matt chrome finish

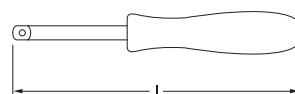

Art. Code	mm	"	mm	"	l mm	g	
2073 0001	6,3	1/4	6,3	1/4	150	90	10

T-Handle Extension

1/4 6.3 1/4 6.3



- Very functional, for hard-to-reach areas
- Can be used as T-Handle or L-Handle
- Can also be used as extension together with a ratchet thanks to inner square C 6.3 on the T-Handle side
- With universal joint for flexible use
- With ball locking device
- For hand-operated sockets and adapters

- Square drive acc. to DIN 3120 - A 6.3 / ISO 1174
- Standards: DIN 3123 / ISO 3316
- Material: Chrome Vanadium
- Surface: Super-Chrom

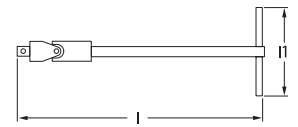

Art. Code	mm	"	mm	"	l mm	"	l1 mm	l1 "	g	
2074 0001	6,3	1/4	6,3	1/4	500	20	200	8	300	10

Converter

3/8 10 1/4 6.3



- With ball locking device
- For hand-operated sockets and adapters
- Square drive acc. to DIN 3120 - A 10 and C 6.3 / ISO 1174
- Standards: DIN 3123 / ISO 3316

- Material: Chrome Vanadium
- Surface: Super-Chrom

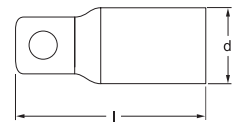

Art. Code	mm	"	mm	"	d mm	l mm	g	
2083 0001	10,0	3/8	6,3	1/4	14	25,5	20	10

Adapter

1/4 6.3 1/4 6.3 1/4 6.3 1/4 6.3



2084 0001



2084 0002

- For inserting bits with hex shank
- With spring clip
- With hexagon socket acc. to DIN 3126 - D 6.3 and inner square C 6.3 acc. to DIN 3120
- Standards: DIN 3126 / 3120

- Material: Chrome Vanadium
- Surface: Super-Chrom

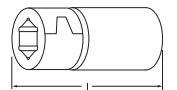

Art. Code	mm	"	mm	"	l mm	g	
2084 0001	6,3	1/4	6,3	1/4	25	15	10

- Connector

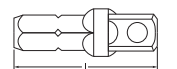

Art. Code	mm	"	mm	"	l mm	g	
2084 0002	6,3	1/4	6,3	1/4	28	15	10

■ Sockets



- For hexagon head screws
- For hand operation
- Square drive acc. to DIN 3120 - C 6.3 / ISO 1174
- With six point profile
- With MATADOR SmartDrive²
- Standards: DIN 3124 / ISO 2725-1

- Material: Chrome Vanadium
- Surface: Super-Chrom

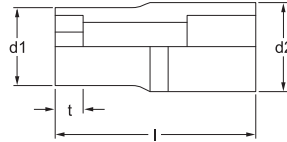

Art. Code	mm	t mm	l mm	d1 mm	d2 mm	g	
2075 0040	4	5	25	6,8	11,9	10	10
2075 0045	4,5	5	25	7,1	11,9	10	10
2075 0050	5	5	25	8,0	11,9	10	10
2075 0055	5,5	5	25	8,3	11,9	11	10
2075 0060	6	5	25	9,3	11,9	11	10
2075 0070	7	5	25	10,5	11,9	12	10
2075 0080	8	5	25	11,9	11,9	12	10
2075 0090	9	8	25	13,0	13,0	19	10
2075 0100	10	8	25	14,0	14,0	17	10
2075 0110	11	8	25	15,9	15,9	24	10
2075 0120	12	8	25	16,9	16,9	27	10
2075 0130	13	10	25	17,8	17,8	31	10
2075 0140	14	10	25	19,6	19,6	38	10



6.3 mm
1/4

Art. Code	*AF	t mm	l mm	d1 mm	d2 mm	g	
2075 8001	1/8	5	25	6,8	11,9	10	10
2075 8002	5/32	5	25	6,8	11,9	10	10
2075 8003	3/16	5	25	8,0	11,9	10	10
2075 8004	7/32	5	25	8,8	11,9	11	10
2075 8005	1/4	5	25	9,3	11,9	11	10
2075 8006	9/32	5	25	10,5	11,9	12	10
2075 8007	5/16	5	25	11,9	11,9	12	10
2075 8008	11/32	5	25	13,0	13,0	19	10
2075 8009	13/32	5	25	13,0	13,0	19	10
2075 8010	3/8	8	25	14,0	14,0	17	10
2075 8011	7/16	8	25	16,0	16,0	24	10
2075 8012	1/2	10	25	17,8	17,8	31	10
2075 8013	9/16	10	25	19,5	19,5	31	10

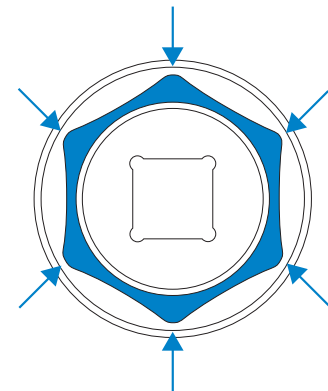

■ Sockets „Mini“, Set



- For hexagon head screws
- The 4 most important sizes in one set
- In practical box with hanger
- For hand operation
- Square drive acc. to DIN 3120 - C 6.3 / ISO 1174

- With six point profile
- With MATADOR SmartDrive²
- Standards: DIN 3124 / ISO 2725-1
- Material: Chrome Vanadium
- Surface: Super-Chrom



Art. Code	a mm	b mm	g	
2075 9040	75	95	80	1



■ Sockets, long type



- For hexagon head screws
- Ideal for deep screw connections
- For hand operation
- Square drive acc. to DIN 3120 - C 6.3 / ISO 1174
- With six point profile
- With MATADOR SmartDrive²

- Standards: DIN 3124 / ISO 2725-1
- Material: Chrome Vanadium
- Surface: Super-Chrom

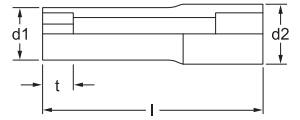

Art. Code	mm	t mm	l mm	d1 mm	d2 mm	g	
2081 0040	4	5	50	6,8	11,9	22	10
2081 0045	4,5	5	50	7,1	11,9	23	10
2081 0050	5	5	50	8,0	11,9	21	10
2081 0055	5,5	5	50	8,3	11,9	21	10
2081 0060	6	8	50	9,3	11,9	22	10
2081 0070	7	8	50	10,5	11,9	23	10
2081 0080	8	8	50	11,9	11,9	25	10
2081 0090	9	11	50	13,0	13,0	30	10
2081 0100	10	11	50	14,6	14,6	40	10
2081 0110	11	11	50	15,9	15,9	45	10
2081 0120	12	13	50	16,9	16,9	53	10
2081 0130	13	13	50	17,8	17,8	70	10
2081 0140	14	16	50	19,6	19,6	75	10

■ Sockets (TORX®)



- For outside TORX® screws
- For hand operation
- Square drive acc. to DIN 3120 - C 6.3 / ISO 1174

- Material: Chrome Vanadium
- Surface: Super-Chrom



Art. Code		t mm	l mm	d1 mm	d2 mm	g	
2090 0040	E4	5	25	7	11,9	12	10
2090 0050	E5	5	25	8	11,9	12	10
2090 0060	E6	5	25	9	11,9	13	10
2090 0070	E7	5	25	9,5	11,9	14	10
2090 0080	E8	8	25	10,5	11,9	13	10
2090 0100	E10	8	25	13,1	14,5	21	10
2090 0110	E11	8	25	13,5	14,5	22	10

■ Sockets „Mini“, Set



- For outside TORX® screws
- The 3 most important sizes in one set
- In practical box with hanger
- For hand operation
- Square drive acc. to DIN 3120 - C 6.3 / ISO 1174

- Material: Chrome Vanadium
- Surface: Super-Chrom

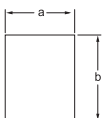

Art. Code	a mm	b mm	g	
2090 9030	75	95	65	1

2090 E8 - E10 - E11

■ Screwdriver Bit Sockets (Slotted)



- For slotted screws
- Extra hard tips made of special steel
- For hand operation
- Square drive acc. to DIN 3120 - C 6.3 / ISO 1174
- Standard: DIN ISO 2380-1 Form B

- Material: Chrome Vanadium / tip made of special steel
- Surface: Super-Chrom / tip manganese phosphated

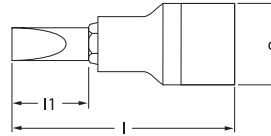

Art. Code	mm	mm	l mm	l1 mm	d mm	g
2076 0040	0,6	4,0	33	14	11,9	12
2076 0055	0,8	5,5	33	14	11,9	12
2076 0070	1,0	7,0	33	14	11,9	13

■ Screwdriver Bit Sockets (PH)



- For cross-slotted screws PH
- Extra hard tips made of special steel
- For hand operation
- Square drive acc. to DIN 3120 - C 6.3 / ISO 1174
- Standard: DIN ISO 8764-1 PH

- Material: Chrome Vanadium / tip made of special steel
- Surface: Super-Chrom / tip manganese phosphated

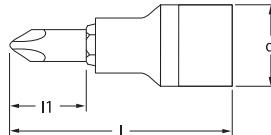

Art. Code	PH	l mm	l1 mm	d mm	g
2077 0001	1	33	14	11,9	14
2077 0002	2	33	14	11,9	14
2077 0003	3	33	14	11,9	15

■ Screwdriver Bit Sockets (PZ)



- For cross-slotted screws PZ
- Extra hard tips made of special steel
- For hand operation
- Square drive acc. to DIN 3120 - C 6.3 / ISO 1174
- Standard: DIN ISO 8764-1 PZ

- Material: Chrome Vanadium / tip made of special steel
- Surface: Super-Chrom / tip manganese phosphated

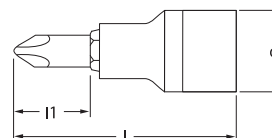

Art. Code	PZ	l mm	l1 mm	d mm	g
2077 0011	1	33	14	11,9	14
2077 0012	2	33	14	11,9	14
2077 0013	3	33	14	11,9	15

■ Screwdriver Bit Sockets (Hex)



- For hexagon socket screws
- Extra hard tips made of special steel
- For hand operation
- Square drive acc. to DIN 3120 - C 6.3 / ISO 1174
- Standard: DIN 7422

- Surface: Super-Chrom / tip manganese phosphated

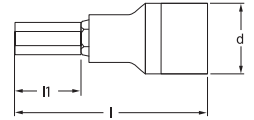

Art. Code	mm	l mm	l1 mm	d mm	g
2078 0030	3	33	14	11,9	12
2078 0040	4	33	14	11,9	12
2078 0050	5	33	14	11,9	13
2078 0060	6	33	14	11,9	14
2078 0070	7	33	14	11,9	13
2078 0080	8	33	14	11,9	21
2078 0100	10	33	14	11,9	22

■ Screwdriver Bit Sockets „Mini“, Set



- For hexagon socket screws
- The 3 most important sizes in one set
- In practical box with hanger
- For hand operation
- Square drive acc. to DIN 3120 - C 6.3 / ISO 1174

- Standard: DIN 7422
- Material: Chrome Vanadium / tip made of special steel
- Surface: Super-Chrom / tip manganese phosphated



Art. Code	a mm	b mm	g
2078 9030	75	95	65

2078 4 - 5 - 6 x 32 mm

■ Screwdriver Bit Sockets (TORX®)



- For recessed TORX® head screws
- Extra hard tips made of special steel
- For hand operation
- Square drive acc. to DIN 3120 - C 6.3 / ISO 1174

- Surface: Super-Chrom / tip manganese phosphated

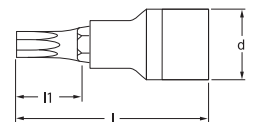

Art. Code	l mm	l1 mm	d mm	g	
2092 0060	T6	33	14	11,9	14
2092 0070	T7	33	14	11,9	14
2092 0080	T8	33	14	11,9	14
2092 0090	T9	33	14	11,9	14
2092 0100	T10	33	14	11,9	14
2092 0150	T15	33	14	11,9	14
2092 0200	T20	33	14	11,9	14
2092 0250	T25	33	14	11,9	14
2092 0270	T27	33	14	11,9	14
2092 0300	T30	33	14	11,9	14
2092 0400	T40	33	14	11,9	15

■ Screwdriver Bit Sockets „Mini“, Set



- For recessed TORX® head screws
- The 4 most important sizes in one set
- In practical box with hanger
- For hand operation
- Square drive acc. to DIN 3120 - C 6.3 / ISO 1174
- Material: Chrome Vanadium / tip made of special steel
- Surface: Super-Chrom / tip manganese phosphated



Art. Code	a mm	b mm	g
2092 9040	75	95	65

2092 T20 - T25 - T30 - T40 x 32 mm

■ Screwdriver Bit Sockets (TORX® with pilot)



- For recessed TORX® screws with pilot
- Extra hard tips made of special steel
- For hand operation
- Square drive acc. to DIN 3120 - C 10 / ISO 1174
- Material: Chrome Vanadium / tip made of special steel
- Surface: Super-Chrom / tip manganese phosphated

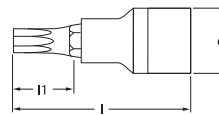

Art. Code	l mm	l1 mm	d mm	g
2093 0080	33	14	11,9	14
2093 0100	33	14	11,9	14
2093 0150	33	14	11,9	14
2093 0200	33	14	11,9	14
2093 0250	33	14	11,9	14
2093 0270	33	14	11,9	14
2093 0300	33	14	11,9	14
2093 0400	33	14	11,9	15



■ Socket Rail



- For wall mounting
- For 14 sockets
- For square drive acc. to DIN 3120 - C 6.3 / ISO 1174

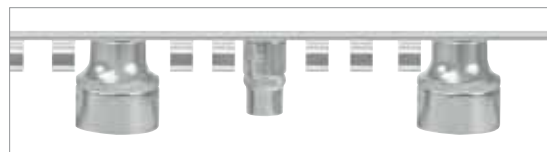

Art. Code	l mm	g
2099 0001	410	67



MATADOR Socket Sets in 6.3 mm (1/4").

In solid metal case.

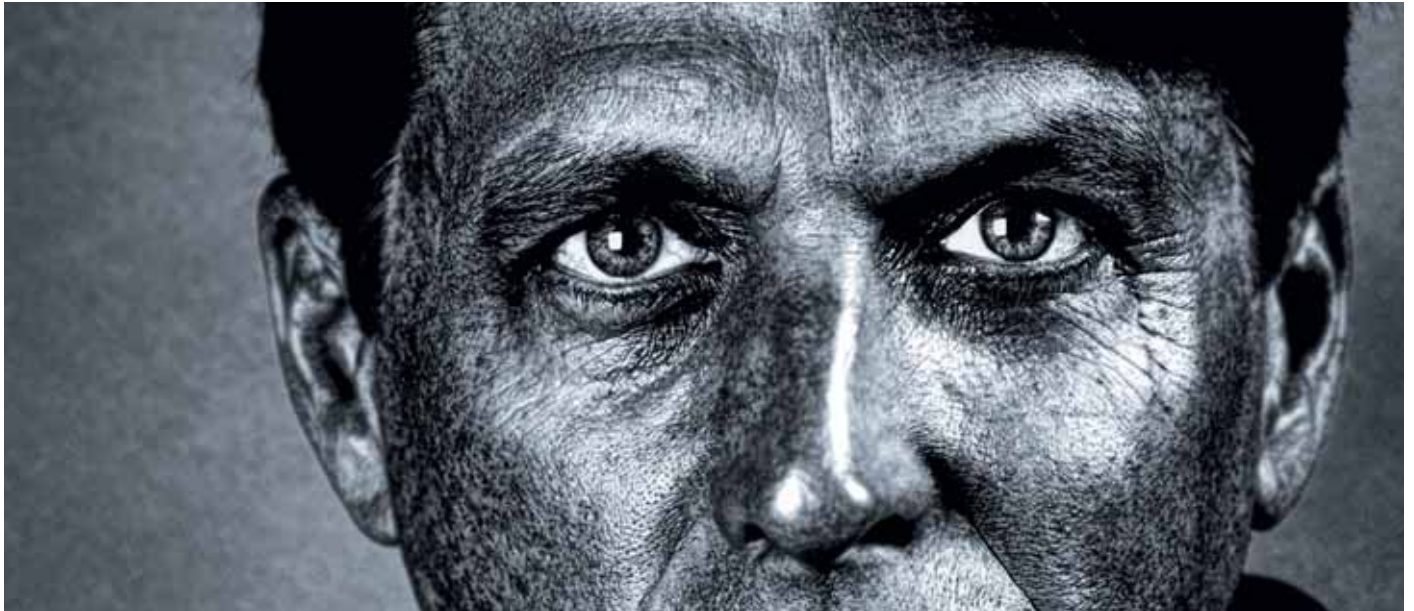

6.3 mm
1/4"

■ Socket Sets 6.3 (1/4)



■ Socket Sets 6.3 (1/4)



Art. Code	16 MM 2061	a mm	b mm	g	
2115 9160	2061	170	105	700	1
	2064 115 mm				
	2065 100 mm				
	2068				
	2073 150 mm				
	2075 4 - 4,5 - 5 - 5,5 - 6 - 7 - 8 - 9 - 10 - 11 - 13 mm				

Art. Code	28 MM 2061	a mm	b mm	g	
2135 9280	2061	220	110	850	1
	2064 115 mm				
	2065 50, 100 mm				
	2068				
	2073 150 mm				
	2075 4 - 4,5 - 5 - 5,5 - 6 - 7 - 8 - 9 - 10 - 11 - 13 mm				
	2076 4 - 5,5 - 7 x 32 mm				
	2077 PH 1 - PH 2 - PH 3 x 32 mm				
	2078 3 - 4 - 5 - 6 - 8 x 32 mm				



MFS MATADOR
FOAM SYSTEM.

With black foam inlay,
resistant against oil and
lubricants.



6.3
mm
1/4

METAL

In solid metal case,
durable quality,
black powder
coated.

With reversible ratchet Z90 (2061).

■ Socket Sets Pro 6.3 (1/4)

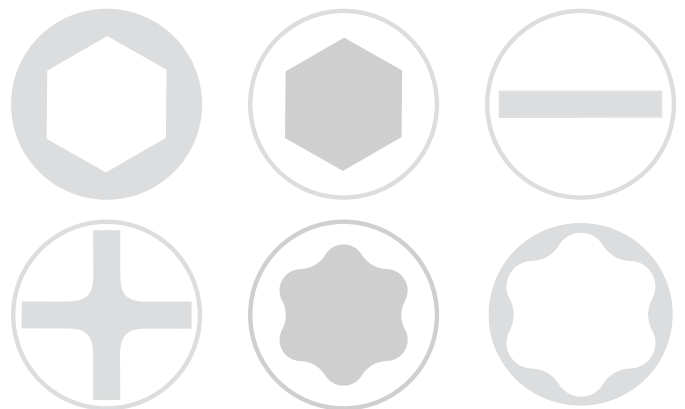

Art. Code	46	MM	6	2061	a mm	b mm	g	
2140 9460					315	115	1100	1
				2064	115 mm			
				2065	50, 100 mm			
				2068				
				2073	150 mm			
				2075	4 - 4,5 - 5 - 5,5 - 6 - 7 - 8 - 9 - 10 - 11 - 12 - 13 - 14 mm			
				2076	4 - 7 x 32 mm			
				2077	PH 1 - PH 2 x 32 mm			
				2077	PZ 1 - PZ 2 x 32 mm			
				2078	3 - 4 - 5 - 6 - 8 x 32 mm			
				2090	E4 - E5 - E6 - E7 - E8 - E10 - E11			
				2092	T8 - T10 - T15 - T20 - T25 - T27 - T30 - T40 x 32 mm			
				2084	6,3 (1/4) - 6,3 (1/4) Bit			



Ratchets and sockets in 10 mm (3/8"). The perfect compromise.

Compact size, high torque values.

25%

reduced angle (only 4°) compared to standard fine-toothed ratchets thanks to an innovative 90-teeth technique. Still ready for working even when it gets really tight.



10 mm
3/8"



max.

ergonomics thanks to multi-component handle, better than standard 1- or 2-component handles. Optimally adapted, spherical shape.

50%

more torque than requested in the DIN standard (e.g. 12.5 mm (1/2") > 750 N·m). Still loosens screws when others have long given up.

4°

■ Reversible Ratchet



- Extremely robust square shank made of Chrome Vanadium steel for high resilience in every situation
- Push-button lock for a safe connection between ratchet and socket
- Recessed, flat lever for quick change of direction
- Fine-toothed with 90 teeth, only 4° swivel angle
- For hand-operated sockets and adapters
- Practical hanging loop to secure the ratchet during construction work or to hang on a tools panel

- Standards: DIN 3122 / ISO 3315
- Material: Chrome Vanadium
- Surface: Matt chrome finish

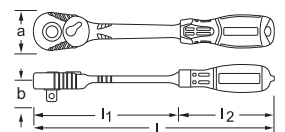

Art. Code	mm	"	l mm	l1 mm	l2 mm	a mm	b mm	g	
3061 0090	10	3/8	200	120	80	29,1	32,8	234	10
3061 0099	Repair Kit							102	1

Sliding T-Handle

3/8 10 mm

- Can be used as T-Handle, with sliding square drive
- With ball locking device
- For hand-operated sockets and adapters
- Square acc. to DIN 3120 - A 10 / ISO 1174

- Standards: DIN 3122 / ISO 3315
- Material: Chrome Vanadium
- Surface: Super-Chrom

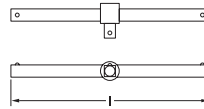

Art. Code	mm	"	l mm	g
3064 0001	10	3/8	200	170

Extensions

3/8 10 mm 3/8 10 mm

- With ball locking device
- With non-slip cross knurling
- For hand-operated sockets and adapters
- With square drive as per DIN 3120 - A 10 and C 10 / ISO 1174

- Standards: DIN 3123 / ISO 3315
- Material: Chrome Vanadium
- Surface: Super-Chrom

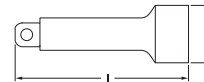

Art. Code	mm	"	mm	"	d mm	l mm	l" mm	g
3065 0050	10	3/8	10	3/8	18	50	5	60
3065 0075	10	3/8	10	3/8	18	75	10	90
3065 0001	10	3/8	10	3/8	18	125	5	120
3065 0002	10	3/8	10	3/8	18	250	10	210

T-Handle Extension

3/8 10 mm 3/8 10 mm

- Very functional, for hard-to-reach areas
- Can be used as T-Handle or L-Handle
- Can also be used as extension together with a ratchet thanks to inner square C 10 on the T-Handle side
- With universal joint for flexible use
- With ball locking device
- For hand-operated sockets and adapters

- With square drive as per DIN 3120 - A 10 / ISO 1174
- Standards: DIN 3123 / ISO 3316
- Material: Chrome Vanadium
- Surface: Super-Chrom

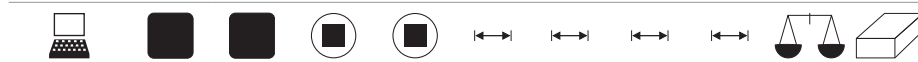
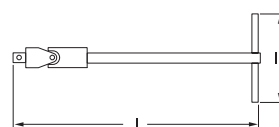

Art. Code	mm	"	mm	"	l mm	l" mm	l1 mm	l1" mm	g
3074 0001	10	3/8	10	3/8	500	20	200	8	350

■ Universal Joint



- With ball locking device
- For hand-operated sockets and adapters
- With square drive as per DIN 3120 - A 10 and C 10 / ISO 1174
- Standards: DIN 3123 / ISO 3316

- Material: Chrome Vanadium
- Surface: Super-Chrom

3/8 10 mm 3/8 10 mm

Art. Code	mm	"	mm	"	d mm	l mm	g	
3068 0001	10	3/8	10	3/8	19	55	75	10

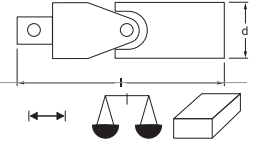

■ Reducer



- With ball locking device
- For hand-operated sockets and adapters
- With square drive as per DIN 3120 - C 10 and A 6.3 / ISO 1174

- Standards: DIN 3123 / ISO 3316
- Material: Chrome Vanadium
- Surface: Super-Chrom

1/4 6.3 mm 3/8 10 mm

Art. Code	mm	"	mm	"	d mm	l mm	g	
3082 0001	6,3	1/4	10	3/8	17	27	30	10

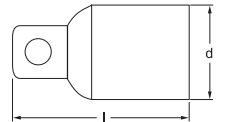

■ Converter



- With ball locking device
- With non-slip cross knurling
- For hand-operated sockets and adapters
- With square drive as per DIN 3120 - C 10 and A 12.5 / ISO 1174

- Standards: DIN 3123 / ISO 3316
- Material: Chrome Vanadium
- Surface: Super-Chrom

1/2 12.5 mm 3/8 10 mm

Art. Code	mm	"	mm	"	d mm	l mm	g	
3083 0001	12,5	1/2	10	3/8	18	35	40	10

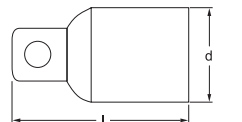

■ Bit Adapter



- For inserting bits with hexagon shank
- With spring clip
- With hexagon socket acc. to DIN 3126 and inner square acc. to DIN 3120 - C 10

- Standards: DIN 3126 / 3120
- Material: Chrome Vanadium
- Surface: Super-Chrom

1/4 6.3 mm 3/8 10 mm

Art. Code	mm	"	mm	"	d mm	l mm	g	
3084 0001	10	3/8	6,3	1/4	17	30	50	10

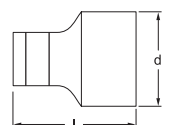

■ Sockets (MM)

- For hexagon head screws
- For hand operation
- Square drive acc. to DIN 3120 - C 10 / ISO 1174
- With six point or double six point profile
- With non-slip cross knurling
- With MATADOR SmartDrive profile
- MATADOR Super-Chrom for long-lasting rust protection

- Standards: DIN 3124 / ISO 2725-1
- Material: Chrome Vanadium
- Surface: Super-Chrom

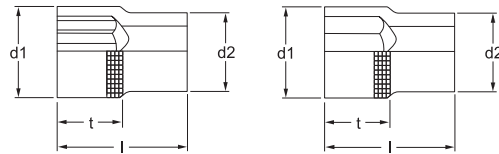

Art. Code	mm	Art. Code	mm	t mm	l mm	d1 mm	d2 mm	g	
3075 0060	6	3075 1060	6	5	28	9,3	17,0	20	10
3075 0070	7	3075 1070	7	5	28	10,6	17,0	22	10
3075 0080	8	3075 1080	8	9	28	11,8	17,0	24	10
3075 0090	9	3075 1090	9	9	28	13,2	17,0	26	10
3075 0100	10	3075 1100	10	9	28	14,5	17,0	30	10
3075 0110	11	3075 1110	11	9	28	15,7	17,0	30	10
3075 0120	12	3075 1120	12	9	28	17,0	17,0	32	10
3075 0130	13	3075 1130	13	9	28	18,0	17,0	35	10
3075 0140	14	3075 1140	14	11	28	19,6	17,0	40	10
3075 0150	15	3075 1150	15	13	28	20,9	18,0	42	10
3075 0160	16	3075 1160	16	13	28	22,0	18,0	48	10
3075 0170	17	3075 1170	17	13	30	23,4	18,0	55	10
3075 0180	18	3075 1180	18	13	30	24,6	18,0	60	10
3075 0190	19	3075 1190	19	13	30	26,0	20,0	70	10
3075 0200	20	3075 1200	20	13	30	27,1	20,0	75	10
3075 0210	21	3075 1210	21	14	30	28,0	20,0	82	10
3075 0220	22	3075 1220	22	15	32	30,0	20,0	85	10

■ Sockets (AF)

- For hexagon head screws
- For hand operation
- Square drive acc. to DIN 3120 - C 10 / ISO 1174
- With non-slip cross knurling
- With MATADOR SmartDrive profile

- MATADOR Super-Chrom for long-lasting rust protection
- Standards: DIN 3124 / ISO 2725-1
- Material: Chrome Vanadium
- Surface: Super-Chrom



Art. Code	"AF		t mm	l mm	d1 mm	d2 mm	g	
3075 8001	1/4	6	6	28	9,2	17,0	20	10
3075 8002	9/32	6	7	28	11,1	17,0	22	10
3075 8003	5/16	6	7	28	11,5	17,0	24	10
3075 8004	11/32	12	7	28	13,0	17,0	26	10
3075 8005	3/8	12	9	28	14,6	17,0	26	10
3075 8006	7/16	12	10	28	16,0	17,0	30	10
3075 8007	1/2	12	12	28	18,0	17,0	30	10
3075 8008	9/16	12	13	28	20,0	17,0	30	10
3075 8009	5/8	12	13	28	22,0	18,0	40	10
3075 8010	11/16	12	14	30	24,0	18,0	50	10
3075 8011	3/4	12	15	30	26,0	20,0	60	10
3075 8012	13/16	12	16	30	28,0	20,0	70	10
3075 8013	7/8	12	18	30	30,0	20,0	80	10

■ Sockets, long type



- For outside TORX® screws
- For hand operation
- Square drive acc. to DIN 3120 - C 10 / ISO 1174
- With non-slip cross knurling

- Material: Chrome Vanadium
- Surface: Super-Chrom

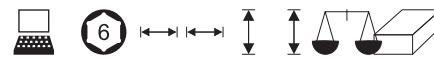

Art. Code	mm	t mm	l mm	d1 mm	d2 mm	g
3081 0080	8	10	65	11,8	17,0	110
3081 0100	10	11	65	14,5	17,0	110
3081 0110	11	12	65	15,7	17,0	120
3081 0120	12	14	65	17,0	16,4	120
3081 0130	13	14	65	18,0	17,0	140
3081 0140	14	17	65	19,6	17,0	140

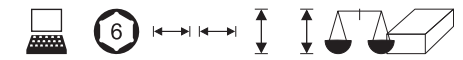

Art. Code	mm	t mm	l mm	d1 mm	d2 mm	g
3081 0150	15	17	65	20,9	18,0	140
3081 0170	17	17	65	23,4	18,0	150
3081 0190	19	20	65	26,0	20,0	150
3081 0210	21	20	65	28,0	20,0	150
3081 0220	22	23	65	30,0	20,0	160

■ Sockets (TORX®)



- For outside TORX® screws
- For hand operation
- Square drive acc. to DIN 3120 - C 10 / ISO 1174
- With non-slip cross knurling
- MATADOR Super-Chrom for long-lasting rust protection

- Material: Chrome Vanadium
- Surface: Super-Chrom

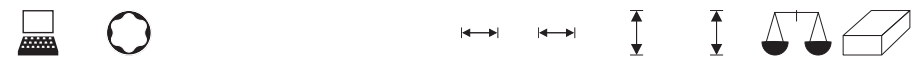
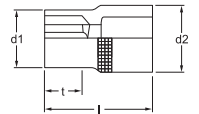

Art. Code		t mm	l mm	d1 mm	d2 mm	g
3090 0060	E6	7	28	10	17	27
3090 0070	E7	7	28	10	17	27
3090 0080	E8	7	28	10	17	27
3090 0100	E10	8	28	12	17	28
3090 0110	E11	8	28	13	17	29
3090 0120	E12	8	28	14	17	30
3090 0140	E14	10	28	15	17	34

■ Screwdriver Bit Sockets (Slotted)



- For slotted screws
- Extra hard tips made of special steel
- For hand operation
- Square drive acc. to DIN 3120 - C 10 / ISO 1174
- Standard: DIN ISO 2380-1 Form B

- Material: Chrome Vanadium / tip made of special steel

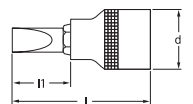

Art. Code	mm	mm	l mm	l1 mm	d mm	g
3076 0070	1,0	7	48	22	18	27
3076 0080	1,2	8	48	22	18	28
3076 0090	1,6	9	48	22	18	29

Screwdriver Bit Sockets (PH)



- For cross-slotted screws PH
 - Extra hard tips made of special steel
 - Square drive acc. to DIN 3120 - C 10 / ISO 1174
 - With non-slip cross knurling
 - Standard: DIN ISO 8764-1 PH
- Material: Chrome Vanadium / tip made of special steel

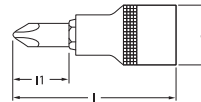

Art. Code	PH	l mm	l1 mm	d mm	g
3077 0001	1	48	22	18	27
3077 0002	2	48	22	18	28
3077 0003	3	48	22	18	29



Screwdriver Bit Sockets (Hex)



- For hexagon socket screws
 - Extra hard tips made of special steel
 - Square drive acc. to DIN 3120 - C 10 / ISO 1174
 - With non-slip cross knurling
 - Standard: DIN 7422
- Material: Chrome Vanadium / tip made of special steel

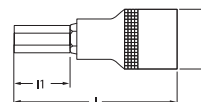

Art. Code	mm	l mm	l1 mm	d mm	g
3078 0040	4	48	22	18	35
3078 0050	5	48	22	18	35
3078 0060	6	48	22	18	36
3078 0070	7	48	22	18	38
3078 0080	8	48	22	18	40
3078 0100	10	48	22	18	48
3078 1040	4	92	66	18	68
3078 1050	5	92	66	18	68
3078 1060	6	92	66	18	68
3078 1070	7	92	66	18	68
3078 1080	8	92	66	18	70
3078 1100	10	92	66	18	71



Screwdriver Bit Sockets (XZN)



- For multi-point screws XZN
 - Extra hard tips made of special steel
 - In standard length (48 mm) or extra long for deep screw connections (92 mm)
 - Square drive acc. to DIN 3120 - C 12.5 / ISO 1174
 - With non-slip cross knurling
- Material: Chrome Vanadium / tip made of special steel
- Surface: Super-Chrom / tip manganese phosphated

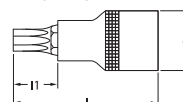

Art. Code		l mm	l1 mm	d mm	g
3079 0050	M5	48	22	18	35
3079 0060	M6	48	22	18	35
3079 0080	M8	48	22	18	36
3079 0100	M10	48	22	18	40
3079 1080	M8	92	66	18	70
3079 1100	M10	92	66	18	82



■ Screwdriver Bit Sockets (TORX®)



- For recessed TORX® screws
- Extra hard tips made of special steel
- In standard length (48 mm) or extra long for deep screw connections (92 mm)
- For hand operation
- Square drive acc. to DIN 3120 - C 10 / ISO 1174
- With non-slip cross knurling

- Material: Chrome Vanadium / tip made of special steel
- Surface: Super-Chrom / tip manganese phosphated

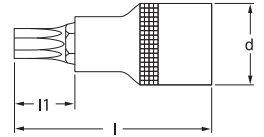

Art. Code		l mm	l1 mm	d mm	g
3092 0100	T10	48	22	18	34
3092 0150	T15	48	22	18	34
3092 0200	T20	48	22	18	34
3092 0250	T25	48	22	18	34
3092 0270	T27	48	22	18	34
3092 0300	T30	48	22	18	35
3092 0400	T40	48	22	18	35
3092 0450	T45	48	22	18	37
3092 0500	T50	48	22	18	45
3092 0550	T55	48	22	18	45

Art. Code		l mm	l1 mm	d mm	g
3092 1150	T15	92	66	18	68
3092 1200	T20	92	66	18	68
3092 1250	T25	92	66	18	68
3092 1270	T27	92	66	18	68
3092 1300	T30	92	66	18	70
3092 1400	T40	92	66	18	71
3092 1450	T45	92	66	18	100
3092 1500	T50	92	66	18	110
3092 1550	T55	92	66	18	110

■ Screwdriver Bit Sockets Set (TORX®)



- For recessed TORX® head screws
- The 7 most important sizes in one set
- In standard length (48 mm) and extra long for deep screw connections (92 mm)
- For hand operation
- Square drive acc. to DIN 3120 - C 6.3 / ISO 1174
- In solid metal case, durable quality, black powder coated

- Material: Chrome Vanadium / tip made of special steel
- Surface: Super-Chrom / tip manganese phosphated

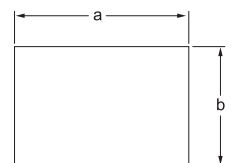

Art. Code		a mm	b mm	g
3092 9140	14	170	105	1000

3092 T20 - T25 - T27 - T30 - T40 - T45 - T50 x 48 mm
T20 - T25 - T27 - T30 - T40 - T45 - T50 x 92 mm

MATADOR Socket Sets 10 mm (3/8").

In solid metal case.



METAL
In solid metal case,
durable quality,
black powder
coated.

MFS MATADOR
FOAM SYSTEM.
With black foam inlay,
resistant against oil and
lubricants.



10
mm
3/8



Socket Sets 10 (3/8)



Socket Sets (TORX®) 10 (3/8)



Art. Code	Icon	Size	a mm	b mm	g	Box
3115 9211		12	315	115	2400	1
		10 3/8				3061
		10 3/8				3065 125, 250 mm
		10 3/8				3068
		10 3/8				3075 6 - 7 - 8 - 9 - 10 - 11 - 12 - 13 - 14 - 15 - 16 - 17 18 - 19 - 20 - 21 - 22 mm

Art. Code	Icon	Size	a mm	b mm	g	Box
3125 9390		6	445	185	3200	1
3125 9391		12	445	185	3200	1
3125 9350		6 AF	445	185	3200	1
		10 3/8				3061
		10 3/8				3065 125, 250 mm
		10 3/8				3068
		10 3/8				3075 6 - 7 - 8 - 9 - 10 - 11 - 12 - 13 - 14 - 15 - 16 - 17 18 - 19 - 20 - 21 - 22 mm AF: 1/4 - 9/32 - 5/16 - 11/32 - 3/8 - 7/16 - 1/2 - 9/16 - 5/8 11/16 - 3/4 - 13/16 - 7/8"
		10 3/8				3078 4 - 5 - 6 - 7 - 8 - 10 x 48 mm
		10 3/8				3090 E8 - E10 - E11 - E12 - E14
		10 3/8				3092 T15 - T20 - T25 - T27 - T30 - T40 - T45 x 48 mm

The new MATADOR Z90 reversible ratchet in 6.3 (1/4"). More teeth. More power. More grip. More applications. More design.

25%

reduced angle (only 4°) compared to standard fine-toothed ratchets thanks to an innovative 90-teeth technique. Still ready for working even when it gets really tight.



12,5 mm
1/2"



max.

ergonomics thanks to multi-component handle, better than standard 1- or 2-component handles. Optimally adapted, spherical shape.

50%

more torque than requested in the DIN standard (e.g. 12.5 mm (1/2") > 750 N·m). Still loosens screws when others have long given up.

4°

■ Reversible Ratchet



- Extremely robust square shank made of Chrome Vanadium steel for high resilience in every situation
- Push-button lock for a safe connection between ratchet and socket
- Recessed, flat lever for quick change of direction
- Fine-toothed with 90 teeth, only 4° swivel angle
- For hand-operated sockets and adapters
- Practical hanging loop to secure the ratchet during construction work or to hang on a tools panel

- Standards: DIN 3122 / ISO 3315
- Material: Chrome Vanadium
- Surface: Matt chrome finish

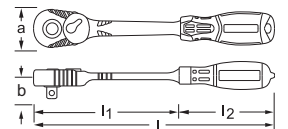

Art. Code	mm	"	l mm	l1 mm	l2 mm	a mm	b mm	g	
4061 0090	12,5	1/2	275	165	110	37,7	42,2	539	10
4061 0092	6,3 - 12,5	1/4 - 1/2	Double Pack						1
4061 0093	6,3 - 10 - 12,5	1/4 - 3/8 - 1/2	Triple Pack						1
4061 0099	Repair Kit							135	1

■ Push-Through Ratchet



- Ideal for step keys for radiator valves
- Robust toothing with 36 teeth
- For hand-operated sockets and adapters
- With square coupler as per DIN 3120 - C 12,5 / ISO 1174

- Standards: DIN 3123 / ISO 3316
- Material: Chrome Vanadium
- Surface: Matt chrome finish

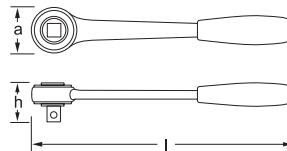

Art. Code	mm	"	l mm	a mm	h mm	g	
4062 0001	12,5	1/2	265	43	39	450	10
4062 0002	Square coupler					50	1



Care instructions for ratchets.

High quality ratchets from MATADOR can be used for a lifetime operation, if they are treated with a little care:

Never use the ratchet as a hammer!

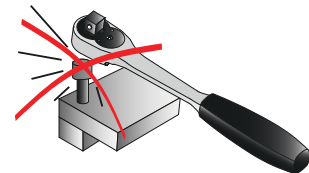

Do not clean the ratchet under water as this reduces the lubrication of the gear mechanism.

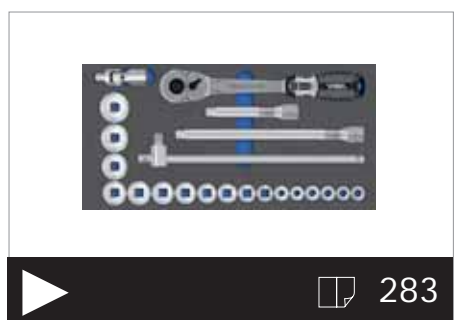
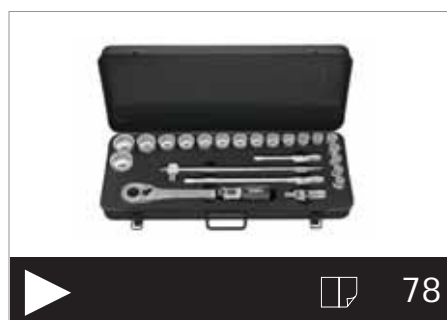
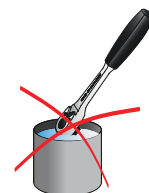

■ Sliding T-Handle

1/2 **12,5 mm**

- Can be used as T- or L-Handle, with sliding square drive
- With ball locking device
- For hand-operated sockets and adapters
- Square acc. to DIN 3120 - A 12.5 / ISO 1174
- Standards: DIN 3122 / ISO 3315

- Material: Chrome Vanadium
- Surface: Super-Chrom

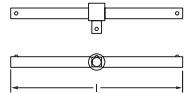

Art. Code	mm	"	l mm	g
4064 0001	12,5	1/2	300	380

■ Extensions

1/2 **12,5 mm** **1/2** **12,5 mm**

- With ball locking device
- With non-slip cross knurling
- For hand-operated sockets and adapters
- Square acc. to DIN 3120 - A 12.5 and C 12.5 / ISO 1174

- Standards: DIN 3123 / ISO 3316
- Material: Chrome Vanadium
- Surface: Super-Chrom



Art. Code	mm	"	mm	"	d mm	l mm	l"	g
4065 0001	12,5	1/2	12,5	1/2	25	75	3	120
4065 0002	12,5	1/2	12,5	1/2	25	125	5	220
4065 0003	12,5	1/2	12,5	1/2	25	250	10	400

■ Extensions (Wobble Type)

1/2 **12,5 mm** **1/2** **12,5 mm**

- Allow the socket to turn off center on the extension by 8° in each direction
- With non-slip cross knurling
- With ball locking device
- For hand-operated sockets and adapters

- Square acc. to DIN 3120 - A 12.5 and C 12.5 / ISO 1174
- Standards: DIN 3123 / ISO 3316
- Material: Chrome Vanadium
- Surface: Super-Chrom

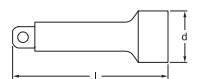
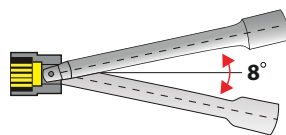

Art. Code	mm	"	mm	"	d mm	l mm	l"	g
4066 0001	12,5	1/2	12,5	1/2	25	125	5	220
4066 0002	12,5	1/2	12,5	1/2	25	250	10	430

■ Universal Joint

1/2 12,5 mm 1/2 12,5 mm

- With ball locking device
- For hand-operated sockets and adapters
- Square acc. to DIN 3120 - A 12.5 and C 12.5 / ISO 1174
- Standards: DIN 3123 / ISO 3316

- Material: Chrome Vanadium
- Surface: Super-Chrom

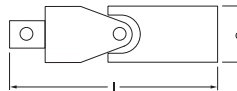

Art. Code	mm	"	mm	"	l mm	g
4068 0001	12,5	1/2	12,5	1/2	75	160

■ Speed Brace

1/2 12,5 mm

- For quick operation
- With black plastic handle
- With ball locking device
- For hand-operated sockets and adapters
- Square acc. to DIN 3120 - A 12.5 / ISO 1174

- Standards: DIN 3122 / ISO 3315
- Material: Chrome Vanadium
- Surface: Super-Chrom

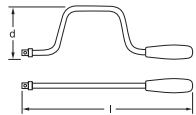

Art. Code	mm	"	d mm	l mm	g
4070 0001	12,5	1/2	130	350	570

■ Swivel Handle

1/2 12,5 mm

- With metal handle
- With ball locking device
- For hand-operated sockets and adapters
- Square acc. to DIN 3120 - A 12.5 / ISO 1174
- Standards: DIN 3122 / ISO 3315

- Material: Chrome Vanadium
- Surface: Super-Chrom

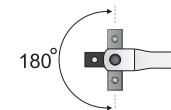
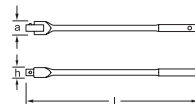

Art. Code	mm	"	l mm	a mm	h mm	g
4072 0001	12,5	1/2	375	30	20	630

■ T-Handle Extension

1/2 12,5 mm 1/2 12,5 mm

- Very functional, for hard-to-reach areas
- With universal joint for flexible use
- Can be used as T-handle or L-handle
- Can also be used as extension together with a ratchet thanks to inner square on the T-handle side
- With ball locking device
- For hand-operated sockets and adapters

- Square acc. to DIN 3120 - A 12.5 and C 12.5 / ISO 1174
- Standards: DIN 3123 / ISO 3316
- Material: Chrome Vanadium
- Surface: Super-Chrom



Art. Code	mm	"	mm	"	l mm	l "	l1 mm	l1 "	g
4074 0001	12,5	1/2	12,5	1/2	500	20	200	8	750

■ Reducer

3/8 10 mm 1/2 12,5 mm



- With ball locking device
- With non-slip cross knurling
- For hand-operated sockets and adapters
- Square acc. to DIN 3120 - A 10 and C 12.5 / ISO 1174

- Standards: DIN 3123 / ISO 3316
- Material: Chrome Vanadium
- Surface: Super-Chrom

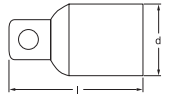

Art. Code	mm	"	mm	"	d mm	l mm	g	
4082 0001	10,0	3/8	12,5	1/2	22	36	50	10

■ Converter

3/4 20 mm 1/2 12,5 mm



- With ball locking device
- For hand-operated sockets and adapters
- Square acc. to DIN 3120 - A 20 and C 12.5 / ISO 1174
- Standards: DIN 3123 / ISO 3316

- Material: Chrome Vanadium
- Surface: Super-Chrom

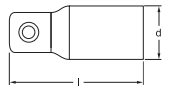

Art. Code	mm	"	mm	"	d mm	l mm	g	
4083 0001	20,0	3/4	12,5	1/2	25	46	110	10

■ Bit Adapters

1/2 12,5 mm



- For hand as well as machine operation
- For inserting bits with hex shank
- With spring clip
- With hexagon socket acc. to DIN 3126 and inner square acc. to DIN 3120 - C 12.5
- Standards: DIN 3126 / 3120

- Material: Chrome Vanadium
- Surface: Super-Chrom

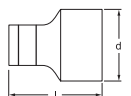

Art. Code	mm	"	mm	"	d mm	l mm	g	
4084 0001	12,5	1/2	6,3	1/4	25	38	45	10
4084 0002	12,5	1/2	7,94	5/16	25	38	60	10
4084 0003	12,5	1/2	11,11	7/16	25	38	80	10

MATADOR Super Chrome.

The original since 1934.

The perfect surface treatment.



■ Sockets (MM)

- For hexagon head screws
- For hand operation
- Square drive acc. to DIN 3120 - C 12.5 / ISO 1174
- With six point or double six point profile
- With non-slip cross knurling
- With MATADOR SmartDrive profile
- MATADOR Super-Chrom for long-lasting rust protection

- Standard: DIN 3124 / ISO 2725-1
- Material: Chrome Vanadium
- Surface: Super-Chrom

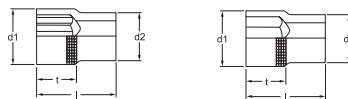

Art. Code	mm	Art. Code	mm	t mm	l mm	d1 mm	d2 mm	g	
4075 0080	8	--	--	6	38	12,2	22,0	45	10
4075 0090	9	--	--	6	38	13,5	22,0	48	10
4075 0100	10	4075 1100	10	7	38	15,0	22,0	50	10
4075 0110	11	4075 1110	11	8	38	16,3	22,0	53	10
4075 0120	12	4075 1120	12	9	38	17,6	22,0	55	10
4075 0130	13	4075 1130	13	9	38	18,8	22,0	60	10
4075 0140	14	4075 1140	14	11	38	20,4	22,0	62	10
4075 0150	15	4075 1150	15	11	38	21,0	22,0	65	10
4075 0160	16	4075 1160	16	11	38	22,0	22,0	68	10
4075 0170	17	4075 1170	17	11	38	24,0	22,0	70	10
4075 0180	18	4075 1180	18	12	38	26,0	22,0	72	10
4075 0190	19	4075 1190	19	12	38	26,0	22,0	80	10
4075 0200	20	4075 1200	20	12	38	28,0	22,0	85	10
4075 0210	21	4075 1210	21	12	38	28,0	26,0	95	10
4075 0220	22	4075 1220	22	14	38	30,0	26,0	100	10
4075 0230	23	4075 1230	23	14	38	32,0	26,0	105	10
4075 0240	24	4075 1240	24	16	38	32,0	26,0	110	10
4075 0250	25	4075 1250	25	16	42	34,0	26,0	120	5
4075 0260	26	4075 1260	26	16	42	36,0	28,0	130	5
4075 0270	27	4075 1270	27	18	42	36,0	28,0	150	5
4075 0280	28	4075 1280	28	18	42	38,0	28,0	165	5
4075 0290	29	4075 1290	29	18	43	38,0	28,0	180	5
4075 0300	30	4075 1300	30	20	44	40,0	28,0	200	5
4075 0320	32	4075 1320	32	20	44	42,0	28,0	210	5
4075 0340	34	4075 1340	34	22	44	44,0	32,0	260	5
4075 0360	36	4075 1360	36	22	46	48,0	34,0	260	5



■ Sockets (AF)



- For hexagon head screws
- For hand operation
- Square drive acc. to DIN 3120 - C 12.5 / ISO 1174
- With double six point profile
- With non-slip cross knurling
- Standards: DIN 3124 / ISO 2725-1
- Material: Chrome Vanadium
- Surface: Super-Chrom

Art. Code	" AF	t mm	l mm	d1 mm	d2 mm	g	
4075 8001	3/8	6	38	15,0	22,0	50	10
4075 8002	7/16	6	38	16,3	22,0	50	10
4075 8003	15/32	8	38	18,8	22,0	60	10
4075 8004	1/2	8	38	18,8	22,0	60	10
4075 8005	9/16	10	38	20,4	22,0	60	10
4075 8006	19/32	10	38	21,0	22,0	60	10
4075 8007	5/8	10	38	22,0	20,5	60	10
4075 8008	21/32	10	38	24,0	22,0	70	10
4075 8009	11/16	10	38	24,0	22,0	70	10
4075 8010	3/4	12	38	26,0	22,0	90	10
4075 8011	25/32	12	38	28,0	22,0	90	10
4075 8012	13/16	12	38	28,0	26,0	90	10
4075 8013	7/8	14	38	30,0	26,0	120	10
4075 8014	15/16	16	38	32,0	26,0	130	5
4075 8015	31/32	16	38	34,0	26,0	150	5
4075 8016	1	16	42	34,0	26,0	150	5
4075 8017	1.1/16	18	42	36,0	28,0	170	5
4075 8018	1.1/8	20	43	38,0	28,0	170	5
4075 8019	1.3/16	20	43	40,0	28,0	200	5
4075 8020	1.1/4	20	43	42,0	28,0	240	5



■ Sockets, long type



- For hexagon head screws
 - For hand operation
 - Square drive acc. to DIN 3120 - C 12.5 / ISO 1174
 - With six point profile
 - With non-slip cross knurling
 - With MATADOR SmartDrive profile
- Standards: DIN 3124 / ISO 2725-1
 - Material: Chrome Vanadium
 - Surface: Super-Chrom

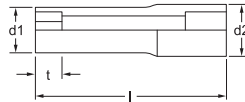

Art. Code	mm	Art. Code	mm	t mm	l mm	d1 mm	d2 mm	g	
4081 0100	10	4081 1100	10	18	77	15,0	22	85	5
4081 0110	11	4081 1110	11	18	77	16,3	22	85	5
4081 0120	12	4081 1120	12	18	77	17,6	22	90	5
4081 0130	13	4081 1130	13	18	77	18,8	22	105	5
4081 0140	14	4081 1140	14	31	77	20,4	22	125	5
4081 0150	15	4081 1150	15	31	77	21,0	22	130	5
4081 0161	16	--	--	31	77	21,0	22	130	5
4081 0170	17	4081 1170	17	31	77	24,0	22	145	5
4081 0181	18	--	--	31	77	24,0	22	145	5
4081 0190	19	4081 1190	19	31	77	26,0	22	165	5
4081 0210	21	4081 1210	21	31	77	28,0	26	205	5
4081 0220	22	4081 1220	22	31	77	30,0	26	200	5
4081 0240	24	4081 1240	24	31	77	32,0	26	250	5
4081 0270	27	4081 1270	27	31	77	36,0	28	270	5
4081 0300	30	4081 1300	30	31	77	40,0	28	330	5
4081 0320	32	4081 1320	32	31	77	42,0	28	410	5



12,5 mm
1/2

■ Sockets (TORX[®])



- For outside TORX[®] screws
 - For hand operation
 - Square drive acc. to DIN 3120 - C 12.5 / ISO 1174
 - With non-slip cross knurling
 - MATADOR Super-Chrom for long-lasting rust protection
- Material: Chrome Vanadium
 - Surface: Super-Chrom

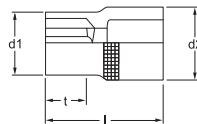

Art. Code		t mm	l mm	d1 mm	d2 mm	g	
4090 0100	E10	22	38	13	22	60	10
4090 0120	E12	22	38	15	22	60	10
4090 0140	E14	22	38	16	22	70	10
4090 0160	E16	22	38	19	22	83	10
4090 0180	E18	22	38	20	22	87	10
4090 0200	E20	24	38	24	22	90	10
4090 0220	E22	26	38	26	22	92	10
4090 0240	E24	28	38	28	22	95	10



■ Screwdriver Bit Sockets (Hex)



- For hexagon socket screws
- Extra hard tips made of special steel
- In standard length (62 mm) or extra long for deep screw connections (100 mm)
- For hand operation
- Square drive acc. to DIN 3120 - C 12.5 / ISO 1174
- With non-slip cross knurling
- MATADOR Super-Chrom for long-lasting rust protection

- Standard: DIN 7422
- Material: Chrome Vanadium / tip made of special steel
- Surface: Super-Chrom / tip manganese phosphated

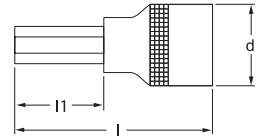

Art. Code	mm	l mm	l1 mm	d mm	g
4078 0040	4	62	24	24	88
4078 0050	5	62	24	24	89
4078 0060	6	62	24	24	89
4078 0070	7	62	24	24	90
4078 0080	8	62	24	24	91
4078 0100	10	62	24	24	95
4078 0120	12	62	24	24	107
4078 0140	14	62	24	24	121
4078 0170	17	62	24	26	162
4078 0190	19	62	24	26	170

Art. Code	mm	l mm	l1 mm	d mm	g
4078 1040	4	100	62	24	95
4078 1050	5	100	62	24	100
4078 1060	6	100	62	24	103
4078 1070	7	100	62	24	105
4078 1080	8	100	62	24	108
4078 1100	10	100	62	24	122
4078 1120	12	100	62	24	130
4078 1140	14	100	62	24	135
4078 1170	17	100	62	26	140
4078 1190	19	100	62	26	150

■ Screwdriver Bit Sockets Set (Hex)



- For hexagon socket screws
- Extra hard tips made of special steel
- The most important screwdriver sockets in one set in standard length (62 mm)
- For hand operation
- Square drive acc. to DIN 3120 - C 12.5 / ISO 1174
- With non-slip cross knurling
- MATADOR Super-Chrom for long-lasting rust protection
- In solid metal case, durable quality, black powder coated

- Standard: DIN 7422
- Material: Chrome Vanadium / tip made of special steel
- Surface: Super-Chrom / tip manganese phosphated

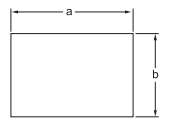

Art. Code	a mm	b mm	g
4078 9090	170	105	1200

4078 5 - 6 - 7 - 8 - 10 - 12 - 14 - 17 - 19 x 62 mm

■ Screwdriver Bit Sockets (XZN)



- For multi-point screws XZN
 - Extra hard tips made of special steel
 - In standard length (62 mm) or extra long for deep screw connections (100 mm)
 - For hand operation
 - Square drive acc. to DIN 3120 - C 12.5 / ISO 1174
 - With non-slip cross knurling
 - MATADOR Super-Chrom for long-lasting rust protection
- Standard: DIN 2324
 - Material: Chrome Vanadium / tip made of special steel
 - Surface: Super-Chrom / tip manganese phosphated

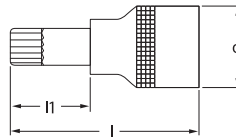

Art. Code		l mm	l1 mm	d mm	g	
4079 0050	M5	62	24	24	89	10
4079 0060	M6	62	24	24	89	10
4079 0080	M8	62	24	24	90	10
4079 0100	M10	62	24	24	91	10
4079 0120	M12	62	24	24	95	10
4079 0140	M14	62	24	24	107	10
4079 0160	M16	62	24	24	121	10

Art. Code		l mm	l1 mm	d mm	g	
4079 1050	M5	100	62	24	100	10
4079 1060	M6	100	62	24	103	10
4079 1080	M8	100	62	24	105	10
4079 1100	M10	100	62	24	108	10
4079 1120	M12	100	62	24	122	10
4079 1140	M14	100	62	24	130	10
4079 1160	M16	100	62	24	135	10



12,5 mm
1/2

■ Screwdriver Bit Sockets Set (XZN)



- For multi-point screws XZN
 - Extra hard tips made of special steel
 - The most important screwdriver sockets
 - For hand operation
 - Square drive acc. to DIN 3120 - C 12.5 / ISO 1174
 - With non-slip cross knurling
 - MATADOR Super-Chrom for long-lasting rust protection
 - In solid metal case, durable quality, black powder coated
- Standard: DIN 2324
 - Material: Chrome Vanadium / tip made of special steel
 - Surface: Super-Chrom / tip manganese phosphated

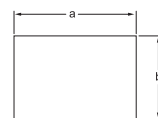

Art. Code		a mm	b mm	g	
4079 9070	4	170	105	1200	1

4079 M5 - M6 - M8 - M10 - M12 x 62 mm
M8 - M10 x 100 mm



■ Screwdriver Bit Sockets (RIBE®)



- For multi-spline screws RIBE®
- Extra hard tips made of special steel
- For hand operation
- With ball locking device
- With non-slip cross knurling
- Square drive acc. to DIN 3120 - C 12.5 / ISO 1174

- Material: Chrome Vanadium / tip made of special steel
- Surface: Super-Chrom / tip manganese phosphated

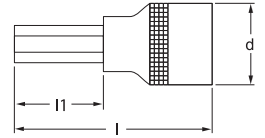

Art. Code		l mm	l1 mm	d mm	g	
4080 0050	M5	62	24	24	88	10
4080 0060	M6	62	24	24	88	10
4080 0080	M8	62	24	24	89	10
4080 0100	M10	62	24	24	89	10
4080 0120	M12	62	24	24	90	10
4080 0140	M14	62	24	24	91	10
4080 0160	M16	62	24	24	95	10

■ Screwdriver Bit Sockets (TORX®)



- For recessed TORX® screws
- Extra hard tips made of special steel
- In standard length (62 mm) or extra long for deep screw connections (100 mm)
- Square drive acc. to DIN 3120 - C 12.5 / ISO 1174

- Material: Chrome Vanadium / tip made of special steel
- Surface: Super-Chrom / tip manganese phosphated



Art. Code		l mm	l1 mm	d mm	g	
4092 0200	T20	62	24	24	59	10
4092 0250	T25	62	24	24	84	10
4092 0270	T27	62	24	24	86	10
4092 0300	T30	62	24	24	88	10
4092 0400	T40	62	24	24	89	10
4092 0450	T45	62	24	24	90	10
4092 0500	T50	62	24	24	91	10
4092 0550	T55	62	24	24	94	10
4092 0600	T60	62	24	26	104	10
4092 0700	T70	62	24	26	110	10
4092 0800	T80	62	24	26	120	10

Art. Code		l mm	l1 mm	d mm	g	
4092 1200	T20	100	62	24	95	10
4092 1250	T25	100	62	24	100	10
4092 1270	T27	100	62	24	105	10
4092 1300	T30	100	62	24	112	10
4092 1400	T40	100	62	24	115	10
4092 1450	T45	100	62	24	115	10
4092 1500	T50	100	62	24	120	10
4092 1550	T55	100	62	24	123	10
4092 1600	T60	100	62	26	130	10
4092 1700	T70	100	62	26	135	10
4092 1800	T80	100	62	26	138	10

■ Screwdriver Bit Sockets Set (TORX®)



- For recessed TORX® screws
 - Extra hard tips made of special steel
 - The most important screwdriver sockets in one set in standard length (62 mm)
 - For hand operation
 - Square drive acc. to DIN 3120 - C 12.5 / ISO 1174
 - With non-slip cross knurling
 - MATADOR Super-Chrom for long-lasting rust protection
- In solid metal case, durable quality, black powder coated
 - Material: Chrome Vanadium / tip made of special steel
 - Surface: Super-Chrom / tip manganese phosphated

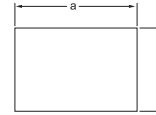

Art. Code	a mm	b mm	g
4092 9090	170	105	1100

4092 T20 - T25 - T27 - T30 - T40 - T45 - T50 - T55 - T60 x 62 mm

■ Screwdriver Bit Sockets (TORX® with pilot)



- For recessed TORX® screws with pilot
 - Extra hard tips made of special steel
 - For hand operation
 - Square drive acc. to DIN 3120 - C 12.5 / ISO 1174
 - With non-slip cross knurling
- Material: Chrome Vanadium / tip made of special steel
 - Surface: Super-Chrom / tip manganese phosphated

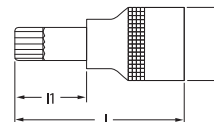

Art. Code	l mm	l1 mm	d mm	g
4093 0200	62	24	24	59
4093 0250	62	24	24	84
4093 0270	62	24	24	86
4093 0300	62	24	24	88
4093 0400	62	24	24	89
4093 0450	62	24	24	90
4093 0500	62	24	24	91
4093 0550	62	24	24	94
4093 0600	62	24	26	104
4093 0700	62	24	26	110
4093 0800	62	24	26	120



■ Screwdriver Bit Sockets Set (TORX® with pilot)



- For recessed TORX® screws with pilot
 - Extra hard tips made of special steel
 - For hand operation
 - Square drive acc. to DIN 3120 - C 12.5 / ISO 1174
 - With non-slip cross knurling
 - In solid metal case, durable quality, black powder coated
- Material: Chrome Vanadium / tip made of special steel
 - Surface: Super-Chrom / tip manganese phosphated

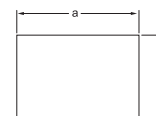

Art. Code	a mm	b mm	g
4093 9090	170	105	1100

4093 T20 - T25 - T27 - T30 - T40 - T45 - T50 - T55 - T60 x 62 mm

MATADOR Socket Sets 12.5 mm (1/2").

In solid metal case.



MFS MATADOR FOAM SYSTEM.

With black foam inlay, resistant against oil and lubricants.



12.5 mm
1/2"

METAL

In solid metal case, durable quality, black powder coated.

Socket Sets 12.5 (1/2)



Art. Code	Icon	Size	a mm	b mm	g	Qty
4114 9230		MM 6	445	185	4400	1
4114 9231		MM 12	445	185	4400	1
		12.5 1/2				4061
		12.5 1/2				4064 300 mm
		12.5 1/2				4065 125, 250 mm
		12.5 1/2				4068
		12.5 1/2				4075 10 - 11 - 12 - 13 - 14 - 15 - 16 - 17 - 18 - 19 - 20 - 21 - 22 23 - 24 - 27 - 30 - 32 mm

Socket Sets PRO 6.3 (1/4) / 12.5 (1/2)



Art. Code	Icon	Size	a mm	b mm	g	Qty
4118 9230		MM 6	445	185	5800	1
4118 9231		MM 12	445	185	5800	1
		6.3 1/4				2061
		6.3 1/4				2065 50 mm
		6.3 1/4				2068
		6.3 1/4				2073 150 mm
		6.3 1/4				2075 4 - 4.5 - 5 - 5.5 - 6 - 7 - 8 - 9 - 10 - 11 - 12 - 13 - 14 mm
		6.3 1/4				2076 4 - 5.5 - 7 x 32 mm
		6.3 1/4				2077 PH 1 - PH 2 x 32 mm
		6.3 1/4				2077 PZ 1 - PZ 2 x 32 mm
		6.3 1/4				2078 3 - 4 - 5 - 6 - 8 x 32 mm
		6.3 1/4				2090 E4 - E5 - E6 - E8
		6.3 1/4				2092 T10 - T15 - T20 - T25 - T27 - T30 x 32 mm
		12.5 1/2				4061
		12.5 1/2				4065 125, 250 mm
		12.5 1/2				4068
		12.5 1/2				4075 10 - 11 - 12 - 13 - 14 - 15 - 16 - 17 - 18 - 19 - 20 - 21 - 22 23 - 24 - 27 - 30 - 32 mm

MATADOR practical add-ons.

In solid metal case.



MFS MATADOR
FOAM SYSTEM.

With black foam inlay,
resistant against oil and
lubricants.

METAL

In solid metal case, durable
quality, black powder coated.

T8 - T60

E4 - E24



12,5
mm
1/2

Socket Sets 12.5 (1/2), long type



Art. Code	Icon	MM	g	a mm	b mm	g	1
4181 9170		6	3800	445	185	3800	1
4181 9171		12	3800	445	185	3800	1
		4081	30 - 32 x 80 mm	10 - 11 - 12 - 13 - 14 - 15 - 17 - 19 - 21 - 22 - 24 - 27			
		4081	16 - 18 - 20,8 mm				

Screwdriver Sockets Set (TORX[®])



Art. Code	Icon	g	a mm	b mm	g	1
4192 9310		3400	315	115	3400	1
		2090	E4 - E5 - E6 - E7 - E8 - E10 - E11			
		2092	T8 - T10 - T15 - T20 - T25 - T27 - T30 - T40 x 32 mm			
		4090	E12 - E14 - E16 - E18 - E20 - E22 - E24			
		4092	T20 - T25 - T27 - T30 - T40 - T45 - T50 - T55 - T60 x 62 mm			



Reversible Ratchet with 20 mm (3/4") drive. 1 600 N·m torque and 72 tooth mechanism.

For heavy maintenance in industry and workshop.



■ Reversible Ratchet (72 T)



- With non-slip metal disc change
- Fine-toothed with 72 teeth
- For hand-operated sockets and accessories with locking pin
- Standards: DIN 3122 / ISO 3315

- Material: Chrome Vanadium
- Surface: Matt chrome finish

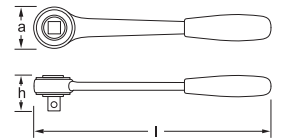

Art. Code	mm	"	l mm	a mm	h mm	g	
5060 0001	20	3/4	510	65	60	2050	5
5060 0010	Repair Kit					450	1

■ Push-Through Ratchet



- Classical Push-Through ratchet
- Robust toothing with 36 teeth
- For hand-operated sockets and adapters
- Square as per DIN 3120 - C 20 / ISO 1174
- Square coupler as per DIN 3120 - A 20
- Standards: DIN 3123 / ISO 3316

- Material: Chrome Vanadium
- Surface: Matt chrome finish

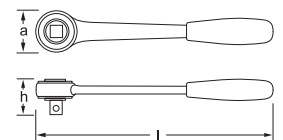

Art. Code	mm	"	l mm	a mm	h mm	g	
5062 0001	20	3/4	510	65	60	1850	5
5062 0002	20	3/4	52	19	19	140	1
5062 0010	Repair kit					450	1
5062 0012	Repair kit for 50620015					450	1

Sliding T-Handle

3/4 20 mm

- Can be used as T- or L-Handle, with sliding square drive
- For hand-operated sockets and adapters with locking pin
- Square acc. to DIN 3120 - B 20 / ISO 1174

- Standards: DIN 3122 / ISO 3315
- Material: Chrome Vanadium
- Surface: Super-Chrom

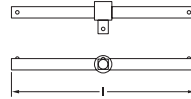

Art. Code	mm	"	l mm	g	
5064 0001	20	3/4	505	1420	5

Extensions

3/4 20 mm 3/4 20 mm

- For hand-operated sockets and adapters with locking pin
- Square acc. to DIN 3120 - B 20 and D 20 / ISO 1174
- Standards: DIN 3123 / ISO 3316

- Material: Chrome Vanadium
- Surface: Super-Chrom

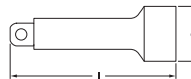

Art. Code	mm	"	mm	"	d mm	l mm	l" mm	g	
5065 0001	20	3/4	20	3/4	36	200	8	650	5
5065 0002	20	3/4	20	3/4	36	400	16	1150	5

Universal Joint

3/4 20 mm 3/4 20 mm

- For hand-operated sockets and adapters with locking pin
- Square acc. to DIN 3120 - B 20 and D 20 / ISO 1174
- Standards: DIN 3123 / ISO 3316

- Material: Chrome Vanadium
- Surface: Super-Chrom

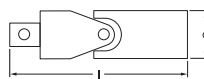

Art. Code	mm	"	mm	"	d mm	l mm	g	
5068 0001	20	3/4	20	3/4	40	105	550	5

Reducer

1/2 12.5 mm 3/4 20 mm

- For hand-operated sockets and adapters with locking pin
- Square acc. to DIN 3120 - B 20 and D 20 / ISO 1174
- Standards: DIN 3123 / ISO 3316

- Material: Chrome Vanadium
- Surface: Super-Chrom

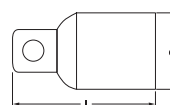

Art. Code	mm	"	mm	"	d mm	l mm	g	
5082 0001	12.5	1/2	20	3/4	40	55	210	5



- For hand-operated sockets and adapters with locking pin
- Square acc. to DIN 3120 - B 20 and D 25 / ISO 1174
- Standards: DIN 3123 / ISO 3316

- Material: Chrome Vanadium
- Surface: Super-Chrom

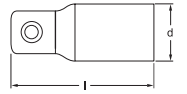

Art. Code	mm	"	mm	"	d mm	l mm	g
5083 0001	25	1	20	3/4	38	63	370

Sockets

- For hexagon head screws
- For hand operation with locking pin
- Square drive acc. to DIN 3120 - D 20 / ISO 1174
- With six point or double six point profile
- With MATADOR SmartDrive profile
- Standard: DIN 3124 / ISO 2725-1

- Material: Chrome Vanadium
- Surface: Super-Chrom



Art. Code	mm	Art. Code	mm	t mm	l mm	d1 mm	d2 mm	g
5075 0190	19	5075 1190	19	19	50	30	36	210
5075 0220	22	5075 1220	22	19	50	33	36	220
5075 0240	24	5075 1240	24	20	50	35	36	220
5075 0270	27	5075 1270	27	24	52	38	36	230
5075 0300	30	5075 1300	30	26	54	42	38	290
5075 0320	32	5075 1320	32	27	56	44	38	300
5075 0330	33	5075 1330	33	27	56	44	40	350
5075 0340	34	5075 1340	34	27	56	47	42	370
5075 0360	36	5075 1360	36	28	58	50	42	430
5075 0380	38	5075 1380	38	28	60	52	45	490
5075 0410	41	5075 1410	41	31	64	56	45	540
5075 0460	46	5075 1460	46	33	68	62	48	630
5075 0500	50	5075 1500	50	35	72	68	48	840
5075 0550	55	5075 1550	55	35	76	74	48	870
5075 0600	60	5075 1600	60	35	78	80	48	950

Art. Code	"AF	t mm	l mm	d1 mm	d2 mm	g
5075 8001	7/8	14,0	50	32,2	36	200
5075 8002	15/16	16,5	51	34,2	36	200
5075 8003	1	16,5	52	37,0	36	250
5075 8004	1.1/16	22,0	52	38,0	36	260
5075 8005	1.3/16	24,0	54	42,0	36	280
5075 8006	1.1/4	24,0	56	44,0	36	320
5075 8007	1.3/8	26,0	58	48,0	38	350
5075 8008	1.7/16	28,0	58	50,0	38	420
5075 8009	1.1/2	28,0	60	52,0	38	460
5075 8010	1.5/8	30,0	64	56,0	40	490
5075 8011	1.13/16	32,0	66	62,0	42	650
5075 8012	1.7/8	34,0	68	64,0	42	670
5075 8013	2	34,0	70	68,0	42	700
5075 8014	2.1/16	36,0	72	70,0	45	750
5075 8015	2.1/4	40,0	76	76,0	45	820



MATADOR Socket Sets in 20 mm (3/4"). For trucks and heavy industry. In solid metal case.



MFS MATADOR FOAM SYSTEM.
With black foam inlay, resistant against oil and lubricants.

METAL

In solid metal case, durable quality, black powder coated.



20 mm
3/4"

Socket Sets 20 (3/4)



Socket Sets 20 (3/4)



Art. Code	Icon	MM	g	a mm	b mm	g	Box
5142 9140	14	6	5060	575	220	12700	1
	20 3/4		5064 500 mm				
	20 3/4		5065 210, 420 mm				
	12.5 1/2		5075 22 - 24 - 27 - 30 - 32 - 36 - 38 - 41 - 46 - 50 mm				

Art. Code	Icon	MM	g	a mm	b mm	g	Box
5143 9160	16	6	5060	575	220	13500	1
5143 9161	16	12	5060	575	220	13500	1
5143 9163	16	6	5062	575	220	13500	1
5143 9164	16	12	5062	575	220	13500	1
	20 3/4		5064 500 mm				
	20 3/4		5065 210, 420 mm				
	12.5 1/2		5075 22 - 24 - 27 - 30 - 32 - 36 - 38 - 41 - 46 - 50 - 55 - 60 mm				

■ Reversible Ratchet

60° 1 25 mm



- Fine-toothed with 60 teeth
- For hand-operated sockets
- With push-fit bar handle

- Standards: DIN 3122 / ISO 3315
- Material: Chrome Vanadium
- Surface: Matt chrome finish

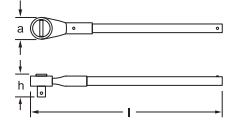

Art. Code	mm	"	l mm	a mm	h mm	g
6060 0001	25	1	610	70	72	3370
6060 0010	Repair Kit					300

■ Sliding T-Handle

1 25 mm



- Can be used as T- or L-Handle, with sliding square drive
- For hand-operated sockets and adapters with locking pin
- Square acc. to DIN 3120 - B 25 / ISO 1174
- Standards: DIN 3122 / ISO 3315

- Material: Chrome Vanadium
- Surface: Super-Chrom

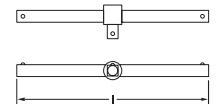

Art. Code	mm	"	l mm	g
6064 0001	25	1	550	3250

■ Extensions

1 25 mm 1 25 mm



- For hand-operated sockets and adapters with locking pin
- Square acc. to DIN 3120 - B 25 and D 25 / ISO 1174
- Standards: DIN 3123 / ISO 3316

- Material: Chrome Vanadium
- Surface: Super-Chrom



Art. Code	mm	"	mm	"	d mm	l mm	l"	g
6065 0001	25	1	25	1	48	200	3	1150
6065 0002	25	1	25	1	48	400	5	1900

■ Reducer

3/4 20 mm 1 25 mm



- With locking pin
- For hand-operated sockets and adapters with locking pin
- Square acc. to DIN 3120 - B 25 and D 20 / ISO 1174
- Standards: DIN 3123 / ISO 3316

- Material: Chrome Vanadium
- Surface: Super-Chrom

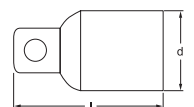

Art. Code	mm	"	mm	"	d mm	l mm	g
6082 0001	20	3/4	25	1	48	63	450

■ Sockets (MM)



- For hexagon head screws
 - For hand operation with locking pin
 - Square drive acc. to DIN 3120 - D 25 / ISO 1174
 - With double six point profile
- Standard: DIN 3124 / ISO 2725-1
 - Material: Chrome Vanadium
 - Surface: Super-Chrom

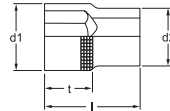

Art. Code	mm	t mm	l mm	d1 mm	d2 mm	g
6075 0360	36	28	65	54	50	650
6075 0410	41	32	69	60	51	750
6075 0460	46	34	75	69	52	900
6075 0500	50	34	75	71	54	1000
6075 0550	55	40	82	77	57	1100
6075 0600	60	42	84	84	57	1500
6075 0650	65	44	87	88	55	1600
6075 0700	70	48	93	94	60	1750
6075 0750	75	52	97	102	60	2100
6075 0800	80	54	103	105	68	2300



■ Socket Set 25 (1)



- For trucks and heavy industry
- All important tools in one set (up to 80 mm)
- In solid metal case

Art. Code	14 MM	12	a mm	b mm	g
6144 9140			730	256	28500

25 1 6060
 25 1 6064 640 mm
 25 1 6065 200, 400 mm
 25 1 6075 36 - 41 - 46 - 50 - 55 - 60 - 65 - 70 - 75 - 80 mm



■ Construction ratchet

- For construction areas
 - With 19 x 22 mm
 - Forged shaft
 - With centre punch
- Material: Chrome Vanadium
 - Surface: Super-Chrom



Art. Code	mm	l mm	g
6200 1922	19 x 22	310	500



Torque Control.

Be a MATADOR.



Content Torque Control.

Page Article group



Torque Wrenches.

93	Torque Screwdrivers
94	Torque Wrenches ECO
95	Torque Wrenches MULTITOUCH
96	Torque Wrenches UNO
98	Torque Wrenches VDE
99	Torque Testers



Insert Tools.

101	Insert Reversible Ratchets
101	Insert Weld-On Fittings
101	Insert Adapter
101	Insert Square Heads
102	Insert Bit Holders
102	Open End Insert Tools
103	Ring End Insert Tools
103	Flared Ring End Insert Tools
104	Sets of Open End Insert Tools 9 x 12
104	Sets of Ring End Insert Tools 9 x 12
105	Set of Insert Tools Basic 9 x 12
105	Sets of Insert Tools Pro 9 x 12
105	Set of Open End Insert Tools 14 x 18
105	Set of Ring End Insert Tools 14 x 18



Multipliers.

107	Torque Multipliers
-----	--------------------



MATADOR torque technique. The basics of controlled tightening.

Whenever it must be safe.



Controlled tightening is the standard of today.

In order to save raw materials, weight and costs, in modern assembly technology screws become more and more small and lightweight. At the same time the requirements increase in terms of durability of a screw connection.

Nowadays for nearly 100% of all industrial screw connections controlled tightening is required.

Controlled means with a predefined torque value or torque angle, so that the remaining clamp force ensures the operating safety of the screw connection.

Screw connections are very complex physical processes influenced by numerous variables. The most important factors that determine the quality of a screw connection are torque, clamp force, friction and joint hardness. Only the knowledge and consideration of all four influencing factors will lead to really safe and reliable screw connections.

What is torque?
Force times distance.

Torque is derived from the physical factors "force times distance" applied to a rotating movement: The longer the distance and/or the higher the force, the higher the rotary force and thus the torque.

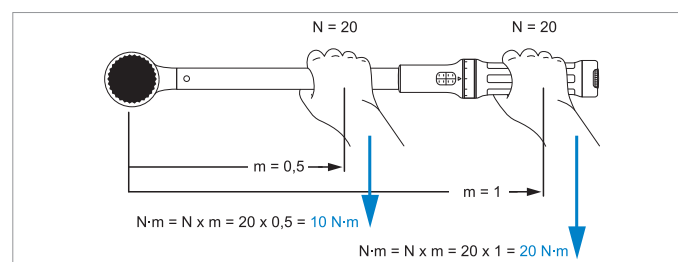

The metric unit that is mainly used to measure torque is newton meter (abbr. N-m). According to this Force F (N) x Lever Arm L (m) = Torque M (N-m).

Torque wrenches measure the force

$$M = F \cdot r$$

that is applied to a screw connection – nothing less, but unfortunately also nothing more.

It is not only length that matters.

Based on the lever rule it is essential that torque wrenches are only operated using the handle. An extension or shortening of the lever arm leads to changed torque values.

This applies for all torque wrenches, unless stated otherwise. E.g. the MATADOR 6174 series torque wrenches with close gap release allow tightening from any position without any value shifts.

In most cases classic torque wrenches are appropriate in order to achieve a controlled manual tightening of screw connections with an adequate accuracy.

Due to friction 90% of applied forces get lost.

But as soon as an optimal and safe screw connection is essential, manual torque wrenches are no longer appropriate. The applied torque is not equal to the reached clamp force and the measured values are thus too inaccurate.

The largest instability factor during tightening is friction that occurs at the thread and below the screw head.

The force known as clamp force, that is supposed to be reached by means of a screw connection, generates a clamping pressure between the screwed workpieces.

The pressure leads to an increased friction between the workpieces and prevents them from coming loose unintentionally. However, these friction forces work against the torque, i.e. they prevent the applied torque from being converted into clamp force to its full extent. Only ~10% of the applied torque is transformed into clamp force.

Torque angle instead of torque value. The better choice when it really counts.

Optimal clamp force without friction losses. To ensure that you get out what you put in.

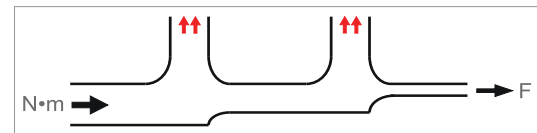
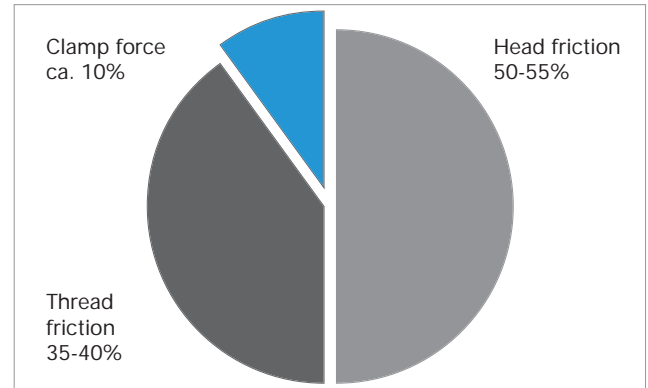
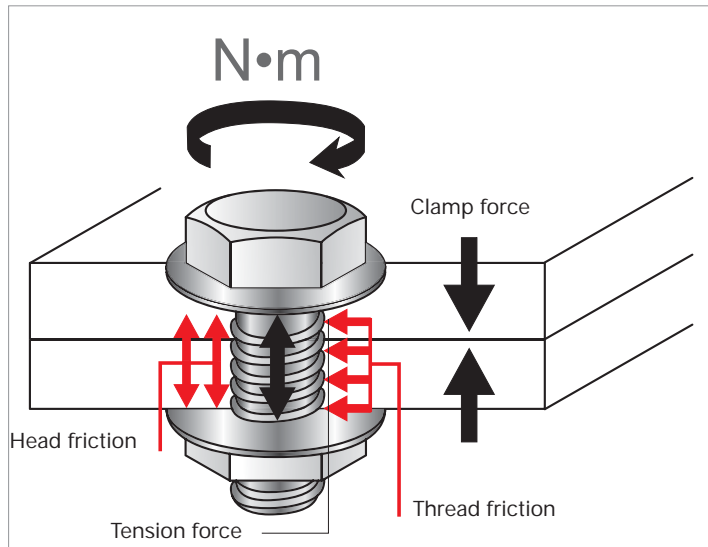

Higher level of accuracy through torque angle.

Minimizing friction to a minimum level.

Each screw is different.

Torque technique for professionals.

In order to achieve a higher level of accuracy also during manual tightening, nowadays – especially in automotive industry – mainly angle-controlled tightening processes are applied.

After being positioned on a work-piece every screw can rotate to a certain extent until its end torque is reached.

This rotation is measured in angular degrees. In case the torque angle between positioning and end torque is low this is called a hard joint (e.g. for metal fittings). In case the angle is high this is called a soft joint (e.g. for wood fittings).

A general rule says that the softer the joint the higher the friction losses and the lower the reached clamp force.

The MATADOR PRO PLUS torque angle wrenches provide a remedy and help the user to reach the optimal clamp force by displaying the torque angle.

During angle-controlled tightening the screw is first tightened to a predetermined trigger torque value – just like during torque-controlled tightening. From this trigger torque value onwards the screw is further rotated by a preset torque angle. The cut-out torque is monitored and documented via internal memory or PC interface.

When torque angle tightening is applied correctly the screw is specifically moved into its plastic deformation. In order to reduce the spreading of the clamp force as far as possible the screw is usually tightened beyond its elastic limit.

If during angle-controlled tightening the screw is only strained within the elastic range the friction is very high and the clamp force spreads accordingly - just like during torque-controlled tightening. Thus exact knowledge about the employed screw is vital.

Required torque and torque angle are mostly stated in the directives for the respective joint.

One has to consider that for angle-controlled tightening only special anti-fatigue bolts with sufficient grip length should be used. Screws that have been used for angle-controlled tightening should not be reused since their strength can be reduced.

No matter how accurate a screw connection is to be tightened: MATADOR has the right torque tools for every case of application.

Starting from simple torque wrenches for semi-professional use up to electric torque/torque angle wrenches – all from a single source.

We will be pleased to assist you.

from 1...	x Factor=	to...	from 1...	x Factor=	to...
Metric measure units					
N-m	0.001=	kN-m	kN-m	1000=	N-m
N-m	0.000001=	MN-m	MN-m	1000000=	N-m
N-m	0.101972=	kpm	kpm	9.80665=	N-m
N-m	1000=	dyn-cm	dyn-cm	0.00100=	N-m
American and British measure units					
N-m	8.850746=	lbf-in (pound force inch)	lbf-in	0.112985=	N-m
N-m	0.737562=	lbf-ft (pound force feet)	lbf-ft	1.355818=	N-m
N-m	141.611930=	ozf-in (ounce force inch)	ozf-in	0.007062=	N-m
N-m	11.800994=	ozf-ft (ounce force feet)	ozf-ft	0.084739=	N-m
N-m	284.764320=	pdl-in (poundal inch)	pdl-in	0.003512=	N-m
N-m	23.730360=	pdl-ft (poundal feet)	pdl-ft	0.042140=	N-m

Torque Conversion Factors

The right torque wrench.

It depends on the case of application.



Dial type or click type?

Dial type torque wrenches indicate the value of the applied torque via a mechanical scale or a dial gauge.

As soon as the target torque is reached the user has to stop exerting additional force on the torque wrench. Dial type torque wrenches are quick and easy to operate and but they are not as accurate as click type torque wrenches.

At click type torque wrenches the target torque value is set via a scale at the handle. As soon as the set target torque value is reached the wrench indicates this by a palpable and audible signal.

In MATADOR torque wrenches the measuring elements made of spring steel are only loaded during tightening. Thus the torque wrench does not need to be reset and the wrench is immediately ready to continue operation.



With or without calibration certificate?

According to DIN EN ISO 6789 torque wrenches are measuring instruments that - in certified companies - are subject to a constant monitoring.

The calibration certificate documents the admissible tolerance a torque wrench reaches if it is loaded 5 000 times in each direction of use with the max. value. Depending on the wrench type DIN EN ISO 6789 demands a max. tolerance of $\pm 6\%$ up to $\pm 4\%$.

After 12 months of use or 5000 load changes a re-calibration of the torque wrench is required.

MATADOR Service.

MATADOR's inexpensive calibration service includes the standard factory certificate according to DIN EN ISO 6789 and on demand also the certificate according to DKD guidelines. We maintain and calibrate MATADOR torque wrenches within 5 days after receipt according to DIN EN ISO 6789 including factory certificate and test badge.



Which drive?

Torque is applied either via the square drive which is used with standard sockets or via a rectangular tool holder (9 x 12 or 14 x 18 mm) for exchangeable insert tools.

When using insert tools it is important to consider that the length of the insert tool corresponds to the set depth gauge. Otherwise the displayed values and the setting values have to be adjusted due to the differing length.



Calibration certificate MATADOR











Overview.

Torque wrenches from 0.1 - 2000 N·m.

Reduction to the essential.



Dial or click type. From 6.3 (1/4") up to 25 (1") square drive.
 With or without angle function. From 5% up to 3% tolerance according to DIN EN ISO 6789. Always with calibration certificate. It is your choice.

MATADOR Torque Wrenches at a glance.									
Art. Code	Model	Art. Grp.	Short description	Type	Tolerance	Standard	Measuring range in N-m	mm	"
6170 0010		6170	Torque Screwdriver for fine mechanics		± 5%	DIN EN ISO 6789	0,1 - 1,2	6,3	1/4
6170 0020							1,0 - 6,0	6,3	1/4
6172 0010		6172	Torque Wrenches ECO, for semi-professional use, 10 - 350 N-m, with calibration certificate		± 4%	DIN EN ISO 6789	10 - 110	10,0	3/8
6172 0020							28 - 210	12,5	1/2
6172 0030							50 - 350	12,5	1/2
6174 0010							5 - 33	10,0	3/8
6174 0030							25 - 150	12,5	1/2
6174 0040							50 - 250	12,5	1/2
6174 0050		6174	Torque Wrenches MULTITOUCH, with close gap release, 5 - 2000 N-m, allows tightening from every position		± 4%	DIN EN ISO 6789	70 - 350	12,5	1/2
6174 0060							140 - 800	20,0	3/4
6174 0070							200 - 1000	25,0	1
6174 0080							500 - 2000	25,0	1
6175 0025							1 - 25	6,3	1/4
6175 0050							5 - 50	10,0	3/8
6175 0100							10 - 100	12,5	1/2
6175 0200		6175	Torque Wrenches UNO, for industry and automotive, 5 - 1.000 N-m, extremely precise and easy to use.		± 3%	DIN EN ISO 6789	20 - 200	12,5	1/2
6175 0340							56 - 340	12,5	1/2
6175 0550							102 - 550	20,0	3/4
6175 0750							140 - 750	20,0	3/4
6175 1000							190 - 1000	25,0	1
6175 5050							5 - 50	9x12	6,3 (1/4)
6175 5100		6175	Torque Wrenches UNO, for insert tools, 5 - 340 N-m, extremely precise and easy to use.		± 3%	DIN EN ISO 6789	10 - 100	9x12	6,3 (1/4)
6175 5200							20 - 200	14x18	12,5 (1/2)
6175 5340							56 - 340	14x18	12,5 (1/2)
Art. Code	Model	Art. Grp.	Short description	Type	Tolerance	Standard	Measuring range in N-m	mm	mm (")
6179 0025		6179	Torque Wrenches VDE, 5 - 220 N-m.		± 4%	DIN EN ISO 6789	5 - 25	10,0	3/8
6179 0100							20 - 100	12,5	1/2
6179 0200							44 - 220	12,5	1/2

MATADOR service. Factory calibration and more in our own laboratory. Traceable to national standards.



What are national standards?

The highest reference level for the calibration of torque tools is the national standard. This standard is the most precise measuring tool used to calibrate other measuring tools.

A national standard is the legally binding basis for a respective physical parameter. In accordance with the international definition this standard represents the lowest possible measurement inaccuracy based on the latest technology.

There is a calibration hierarchy of standards within which the measurement accuracy decreases from level to level. This structure makes it possible to compare test results worldwide and to guarantee traceability to a national standard. In certified companies measuring equipment must be traceable to national standards and has to be recalibrated regularly. This monitoring of measuring devices is a means of quality assurance and ensures uniform and reliable high-quality measuring results.

The MATADOR factory calibration.

All MATADOR torque wrenches are produced to the highest quality standards, adjusted, traceably calibrated and certified. Each tool comes with a factory calibration certificate.

If requested MATADOR torque wrenches are recalibrated within 5-7 workdays at a reasonable price. Also, the tools can be repaired in-house at any time.

DAkkS certificate on request.

For a 100% documentation MATADOR can also provide a calibration certificate according to DAkkS standards in cooperation with an accredited laboratory. Calibration is then directly traceable to the national standard and reaches the highest level of accuracy.

Please feel free to contact us.

What is made during recalibration?

Torque tools are measuring instruments and are subject to natural wear. We thus recommend to have torque wrenches recalibrated at regular intervals (generally once a year) or at least after 5000 load cycles to guarantee long-term precision.

During recalibration in our in-house laboratory the torque wrenches are checked for their proper function and then - according to DIN EN ISO 6789 - tested at 20%, 60% and 100% of the maximum torque.

At any test point 5 measurements are made and documented. If the measured values are within the tolerance a factory calibration certificate is issued. If the measured values do not meet the requested tolerance the torque wrench is adjusted and the test procedure is repeated.

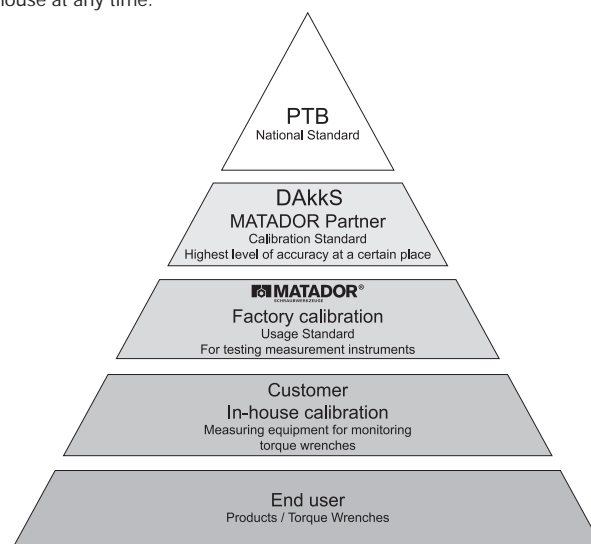

MATADOR Torque Screwdriver.

Little effort - big effect.

Controlled screw tightening in confined spaces.



■ Torque Screwdrivers

- For controlled tightening of screws from 0.1 - 6 N·m
- Manually adjustable to individual target values
- Easily readable micrometer scale
- Accuracy $\pm 5\%$ tolerance from set scale value
- Precise reading accuracy for a minimum of 5,000 tightening cycles
- For controlled tightening in clockwise and anti-clockwise direction
- Clearly palpable and audible torque release
- Ergonomic design of the handle for safe torque transmission
- With square drive for bits according to DIN 3126
- C 6.3, together with adapter also usable for sockets with square drive according to DIN 3124 C 6.3 (not included, art. code 2084 0002)
- With individual serial number for clear product identification
- Including calibration certificate according to DIN EN ISO 6789



Art. Code	mm	"	cN·m	N·m	cN·m	N·m	l mm	g	
6170 0010	6,3	1/4	10-120	0,1-1,2	1,0	--	180	207	1
6170 0020	6,3	1/4	--	1-6		0,1	248	475	1



MATADOR Torque Wrenches ECO. Save your budget.

For semi-professional use.

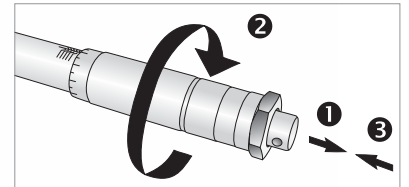

■ Torque Wrenches ECO

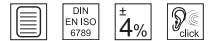

- Click type torque wrenches for semi-professional use
- Accuracy $\pm 4\%$ tolerance from the set scale value
- Precise reading accuracy for a minimum of 5000 tightening cycles
- For controlled clockwise and anti-clockwise tightening (thus not for untightening)
- With knurled steel handle for easy adjustment of the desired torque value
- Durable double scale thanks to stamping in N-m and m-kgs with fine adjustment
- Clearly audible release
- With square drive according to DIN 3120 - ISO 1174 with ball stop and integrated lever reversible ratchet
- With individual serial number and calibration certificate according to DIN EN ISO 6789
- In attractive DIY packaging

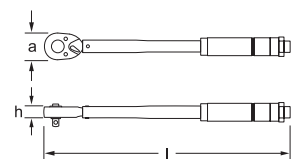

Art. Code	mm	"	N-m	m-kgs	N-m	m-kgs	a mm	h mm	l mm	g
6172 0010	10,0	3/8	10 - 110	1 - 11	1	0,1	37,0	15,0	370	600
6172 0020	12,5	1/2	28 - 210	3 - 21	1	0,1	46,0	17,5	470	800
6172 0030	12,5	1/2	50 - 350	5 - 35	1	0,1	41,0	20,5	630	1000

MATADOR Torque Wrenches MULTITOUCH.

No offsets, no matter where you touch.

Absolutely error-free operation thanks to single lever mechanism.

Tightening from every position due to uniaxial position of pivot and square drive.

Ergonomic handle with protected adjustment mechanism.



Torque Wrenches MULTITOUCH

- Click type torque wrench
- Accuracy $\pm 4\%$ tolerance of the set scale value
- For continuous heavy duty operation at construction sites, in workshops and industry
- Especially simple operation and long durability thanks to single lever mechanism
- Precise reading accuracy for a minimum of 5000 tightening cycles
- For controlled clockwise and anti-clockwise tightening
- Permanently readable quad scale
- Clearly audible and palpable release
- With push-through square according to DIN 3120 - ISO 1174 with ball stop
- With individual serial number and calibration certificate according to DIN EN ISO 6789

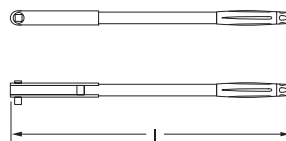

Art. Code	mm	"	N·m	lbf·ft	lbf·in	kgf·m	N·m	l mm	g
6174 0010	10,0	3/8	5 - 33	4 - 24	40 - 300	0,5 - 3,4	0,5	405	690
6174 0030	12,5	1/2	25 - 150	20 - 110	200 - 1300	2,5 - 15	2	575	1700
6174 0040	12,5	1/2	50 - 250	40 - 180	450 - 2200	5 - 25	5	605	2300
6174 0050	12,5	1/2	70 - 350	50 - 260	500 - 3100	7 - 35	10	815	3000
6174 0060	20,0	3/4	140 - 800	120 - 580	1400 - 7000	14 - 80	20	815	6500
6174 0070	25,0	1	200 - 1000	150 - 750	1500 - 8500	20 - 100	25	1030	9700
6174 0080	25,0	1	500 - 2000	350 - 1500	4500 - 17500	50 - 200	50	1400	18000

- Spare squares:

Art. Code	mm	"	g
6174 0910	10,0	3/8	50
6174 0930	12,5	1/2	70
6174 0960	20,0	3/4	90
6174 0980	25,0	1	120



Torque wrenches UNO.

One window. One value. One grip. One click.



Art. Code	mm / "	N-m		g	
6175 0010	6.3 mm 1/4	1 - 25	Repair Kit UNO	--	1
6175 0011	10 mm 3/8	5 - 50	Repair Kit UNO	--	1
6175 0012	12.5 mm 1/2	10 - 100	Repair Kit UNO	--	1
6175 0013	12.5 mm 1/2	20 - 200	Repair Kit UNO	--	1
6175 0016	12.5 mm 1/2	56 - 340	Repair Kit UNO	--	1
6175 0014	20 mm 3/4	102 - 550	Repair Kit UNO	--	1
6175 0015	25 mm 1	190 - 1000	Repair Kit UNO	--	1



Make complicated things simple.



Easy setting at the end of the handle.



Only one window with clear numeric value in N-m.



Error-free handling thanks to double-sided finger grooves.



Integrated lever ratchet with small head to reach tiny areas.



Well protected in solid plastic case.

Extremely precise and easy to use.

The new professional torque wrench by MATADOR with an **absolutely innovative operating concept**:

Easy setting with extra fine graduation (from 0.5 N·m to 1.0 N·m on larger models), **only one window with clear numeric value in N·m**. No division scale which is difficult to read.

With small ratchet head to reach tiny spaces, with lever and 48 teeth, safety lock and quick-release function. Permanent protection of the body thanks to full powder coating.

The handy and ergonomically optimal design of the handle with its integrated finger grooves make the correct use a breeze. Clearly audible and perceptible signal when the desired torque value is reached.

The MATADOR UNO is extremely precise: **maximum deviation only ±3%** from the set scale value. For controlled clockwise operation. With German calibration certificate according to DIN EN ISO 6789.



From 5 - 1,000 N·m. For industry and automotive.

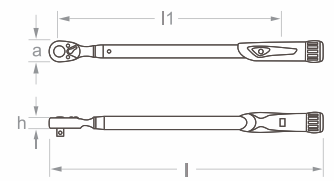

Art. Code	mm / "	N·m	l1 mm	a mm	h mm	l mm	g	
6175 0025	6.3 mm 1/4	1 - 25	250	22.5	19.6	343	760	1
6175 0050	10 mm 3/8	5 - 50	322	31.2	26.7	419	983	1
6175 0100	12.5 mm 1/2	10 - 100	337	41.0	36.4	440	998	1
6175 0200	12.5 mm 1/2	20 - 200	435	41.0	36.4	540	1360	1
6175 0340	12.5 mm 1/2	56 - 340	538	41.0	36.4	640	1730	1
6175 0550	20 mm 3/4	102 - 550	827	58.0	55.0	938	4500	1
6175 0750	20 mm 3/4	140 - 750	1107	58.0	55.0	1218	5850	1
6175 1000	25 mm 1	190 - 1000	1393	67.0	67.0	1508	7426	1
6175 5050	9x12 mm	5 - 50	322	31.2	26.7	378	886	1
6175 5100	9x12 mm	10 - 100	322	31.2	26.7	378	886	1
6175 5200	14x18 mm	20 - 200	435	41.0	36.4	490	1180	1
6175 5340	14x18 mm	56 - 340	538	41.0	36.4	595	1554	1

Torque Wrenches VDE.

Safety first.

1000 V



■ Torque Wrenches VDE

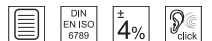

- Click type torque wrench with reversible ratchet head
- Accuracy $\pm 4\%$ tolerance from the set scale value
- Precise reading accuracy for a minimum of 5000 tightening cycles
- For controlled clockwise and anti-clockwise tightening
- Clearly palpable and audible torque release
- Double scale in N-m and lbf-ft
- Robust ratchet mechanism
- Large vision panel with magnifiers for optimal readability of the set values
- Ergonomic and hand-friendly handle
- Safety lock at the end of the handle
- With square drive according to DIN 3120 - ISO 1174 with ball stop
- With individual serial number and test certificate according to DIN EN ISO 6789

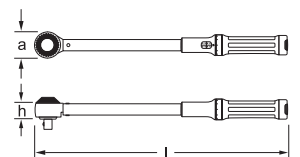

Art. Code	mm	"	N-m	lbf-ft	N-m	a mm	h mm	l mm	g
6179 0025	10,0	3/8	5 - 25	4 - 20	0,25	35	18	289	410
6179 0100	12,5	1/2	20 - 100	15 - 74	0,50	45	23	350	1378
6179 0200	12,5	1/2	44 - 220	32 - 162	0,50	45	23	412	1500



MATADOR Torque Testers.

Turn on, test, ready.

Very simple and cost effective.

± 1%
10 - 2000 N·m,
(7,4 - 1475 lbf·ft).

With inner square drive
12.5 mm (1/2").

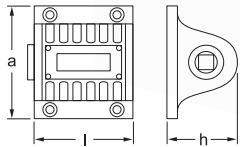

For click type, dial and digital
torque wrenches:
Model 6180 Plus.



With 27 mm male hexagon, supplied
with 20 mm (3/4") or 25 mm (1")
square drive socket.

Torque Testers

- For easy testing and calibration of click type torque wrenches
- Simple operation, only one button to zero the display
- Large 4-digit LCD-Display
- With automatic switch-off
- Inner square according to DIN 3120 / ISO 1174 with ball stop
- Measurement in N·m
- Delivered in solid black plastic case with power cable
- With traceable calibration certificate for clockwise direction according to DIN EN ISO 6789

Model 6180 Plus for click type, dial and digital torque wrenches

- Additionally equipped with
- Display for three torque units: N·m, lbf·ft and lbf·in
- Three operation modes: track mode for continuous monitoring of torque signal, 1st peak mode or final peak mode
- Limit feature: the operator sets target torque and tolerance and instrument calculates whether the reading is within tolerance and indicates the result by illuminating one of three coloured LEDs
- Delivered with RS-232 lead
- Software separately available



Art. Code	mm	"	mm	N·m	lbf·ft	a mm	h mm	l mm	g	
6180 0001	12,5	1/2		10 - 350	7,4 - 258	145,5	85,0	150,0	3200	1
6180 0002	20,0	3/4	27 mm	100 - 1000	74 - 737	145,5	85,0	175,0	4800	1
6180 0003	25,0	1	27 mm	200 - 2000	147 - 1475	145,5	85,0	175,0	5600	1

Model 6180 Plus:

Art. Code	mm	"	mm	N·m	lbf·ft	a mm	h mm	l mm	g	
6180 0011	12,5	1/2		10 - 350	7,4 - 258	145,5	85,0	150,0	3200	1
6180 0012	20,0	3/4	27 mm	100 - 1000	74 - 737	145,5	85,0	175,0	4800	1
6180 0013	25,0	1	27 mm	200 - 2000	147 - 1475	145,5	85,0	175,0	5600	1



Insert tools for rectangular tool holders.

Directly from certified manufacturer.

For rectangular cavities sized 9 x 12 or 14 x 18 mm.



With depth gauges (s_k) for 9 x 12 mm = 17.5 mm, for 14 x 18 mm = 25 mm, other values are marked with *).

Customized insert tools.

MATADOR is first-level supplier of insert tools for numerous leading automobile manufacturers. Also special, extra flat insert ratchets with lever are part of our range.



We would be pleased to submit an individual offer to you based on your special requirements - either as hot formed forging parts, as cast parts or cut on modern CNC machines from solid material.

Please do not hesitate to contact us.

When do you have to calculate?

The calibration of a torque wrench is based on a fixed fulcrum (usually at the same level as the square drive). If the measure of length changes the original lever is no longer valid and the set torque value (M_{xW}) has to be adjusted by a correction factor.

Example:

Correction of the set torque value:

Desired tightening torque $M_A = 180 \text{ N}\cdot\text{m}$:

$$180 \cdot \frac{435}{442,5} = \frac{78.300}{442,5} = 176,95 \text{ N}\cdot\text{m}$$

Model	Size	Material	Weight	Length	Width	Height	Depth Gauge	Correction Factor
ETW 001	9x12	Alu	0,25	175	35	40	17,5	1
ETW 002	9x12	Alu	0,25	175	35	40	17,5	1
ETW 003	14x18	Alu	0,30	225	45	50	25	1
ETW 004	14x18	Alu	0,30	225	45	50	25	1
ETW 005	14x18	Alu	0,30	225	45	50	25	1
ETW 006	14x18	Alu	0,30	225	45	50	25	1
ETW 007	14x18	Alu	0,30	225	45	50	25	1
ETW 008	14x18	Alu	0,30	225	45	50	25	1
ETW 009	14x18	Alu	0,30	225	45	50	25	1
ETW 010	14x18	Alu	0,30	225	45	50	25	1
ETW 011	14x18	Alu	0,30	225	45	50	25	1
ETW 012	14x18	Alu	0,30	225	45	50	25	1
ETW 013	14x18	Alu	0,30	225	45	50	25	1
ETW 014	14x18	Alu	0,30	225	45	50	25	1
ETW 015	14x18	Alu	0,30	225	45	50	25	1
ETW 016	14x18	Alu	0,30	225	45	50	25	1
ETW 017	14x18	Alu	0,30	225	45	50	25	1
ETW 018	14x18	Alu	0,30	225	45	50	25	1
ETW 019	14x18	Alu	0,30	225	45	50	25	1
ETW 020	14x18	Alu	0,30	225	45	50	25	1
ETW 021	14x18	Alu	0,30	225	45	50	25	1
ETW 022	14x18	Alu	0,30	225	45	50	25	1
ETW 023	14x18	Alu	0,30	225	45	50	25	1
ETW 024	14x18	Alu	0,30	225	45	50	25	1
ETW 025	14x18	Alu	0,30	225	45	50	25	1
ETW 026	14x18	Alu	0,30	225	45	50	25	1
ETW 027	14x18	Alu	0,30	225	45	50	25	1
ETW 028	14x18	Alu	0,30	225	45	50	25	1
ETW 029	14x18	Alu	0,30	225	45	50	25	1
ETW 030	14x18	Alu	0,30	225	45	50	25	1

Correction of the torque value.

Insert tools with different depth gauges (s) are marked with a * in the respective table.

In these cases and also when using adapters the desired tightening torque (M_A) has to be corrected by the linear factor with the help of the following formula:

$$M_{xW} = \frac{M_A \times l_k}{l_k + (s - s_k)}$$

■ Insert Reversible Ratchets

- With pin lock
- Material: Chrome-Vanadium
- Fine-toothed
- Surface: Matt chrome finish
- Max. load of coupler 9 x 12:
6.3 (1/4) = 30 N·m, 10 (3/8) = 135 N·m,
12.5 (1/2) = 150 N·m
- Max. load of coupler 14 x 18:
12.5 (1/2) = 340 N·m, 20 (3/4) = 400 N·m

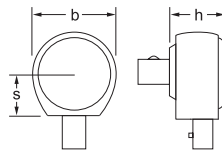

Art. Code	mm	mm	"	s mm	b mm	h mm	g	
6186 0001	9 x 12	6,3	1/4	17,5	27	25	75	1
6186 0002	9 x 12	10,0	3/8	17,5	35	35	152	1
6186 0003	9 x 12	12,5	1/2	17,5	43	40	228	1
6186 0004	14 x 18	12,5	1/2	25,0	43	43	260	1
6186 0005	14 x 18	20,0	3/4	25,0	70	60	795	1

■ Insert Weld-On Fittings

- With pin lock
- For welding special tools
- Welding surface 8 x 14 mm (9 x 12) and 11 x 25 mm (14 x 18)
- *) = please consider the depth gauge (s) for correct calculation of the torque value

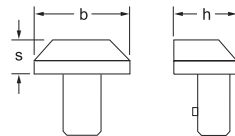

Art. Code	mm	s mm	b mm	h mm	g	
6187 0001	9 x 12	8*	14	14,5	47	1
6187 0002	14 x 18	12*	25	21,5	100	1

■ Insert Adapter

- Adapter for confined areas
- With 20° angle
- With pin lock
- *) = please consider the depth gauge (s) for correct calculation of the torque value

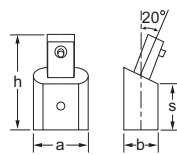

Art. Code	mm	mm	s mm	b mm	h mm	a mm	g	
6187 0004	9 x 12	9 x 12	20*	17	40	22	47	1

■ Insert Square Heads

- Max. load of coupler 9 x 12:
6.3 (1/4) = 30 N·m, 10 (3/8) = 135 N·m,
12.5 (1/2) = 150 N·m
- Max. load of coupler 14 x 18:
12.5 (1/2) = 340 N·m, 20 (3/4) = 400 N·m

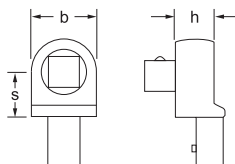

Art. Code	mm	mm	"	s mm	b mm	h mm	g	
6188 0001	9 x 12	6,3	1/4	17,5	20	14	70	1
6188 0002	9 x 12	10,0	3/8	17,5	20	14	76	1
6188 0003	9 x 12	12,5	1/2	17,5	20	14	80	1
6188 0004	14 x 18	12,5	1/2	25,0	27	18	210	1
6188 0005	14 x 18	20,0	3/4	25,0	40	25	400	1

■ Insert Bit Holders



- For inserting bits
- With pin lock
- Material: Chrome-Vanadium
- Surface: Matt chrome plated

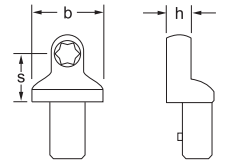

Art. Code	mm	mm	"	s mm	b mm	h mm	g	
6189 0001	9 x 12	6,3	1/4	17,5	14	10,0	47	1
6189 0002	9 x 12	8,0	5/16	17,5	16	12,5	47	1
6189 0003	14 x 18	8,0	5/16	25,0	16	12,5	115	1

■ Open End Insert Tools



- With pin lock
- *) = please consider the depth gauge (s) for correct calculation of the torque value
- Material: Chrome-Vanadium
- Surface: Matt chrome plated

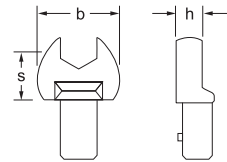

Art. Code	mm	mm		s mm	b mm	h mm	g	
6190 0070	9 x 12	7		17,5	22	5,0	37	1
6190 0080	9 x 12	8		17,5	22	5,0	38	1
6190 0090	9 x 12	9		17,5	26	5,5	37	1
6190 0100	9 x 12	10		17,5	26	5,5	42	1
6190 0110	9 x 12	11		17,5	26	5,5	40	1
6190 0120	9 x 12	12		17,5	30	7,0	41	1
6190 0130	9 x 12	13		17,5	30	7,0	46	1
6190 0140	9 x 12	14		20,0*	35	8,0	55	1
6190 0150	9 x 12	15		20,0*	35	8,0	55	1
6190 0160	9 x 12	16		20,0*	38	8,5	58	1
6190 0170	9 x 12	17		20,0*	38	8,5	58	1
6190 0180	9 x 12	18		20,0*	42	9,0	60	1
6190 0190	9 x 12	19		20,0*	42	9,0	64	1
6190 1130	14 x 18	13		25,0	30	7,0	118	1
6190 1140	14 x 18	14		25,0	35	8,0	120	1
6190 1150	14 x 18	15		25,0	35	8,0	116	1
6190 1160	14 x 18	16		25,0	38	9,0	128	1
6190 1170	14 x 18	17		25,0	38	9,0	138	1
6190 1180	14 x 18	18		25,0	42	10,0	136	1
6190 1190	14 x 18	19		25,0	42	10,0	140	1
6190 1210	14 x 18	21		25,0	50	11,0	160	1
6190 1220	14 x 18	22		25,0	50	11,0	163	1
6190 1240	14 x 18	24		25,0	53	12,0	165	1
6190 1260	14 x 18	26		25,0	60	13,0	168	1
6190 1270	14 x 18	27		32,5*	60	13,0	240	1
6190 1300	14 x 18	30		32,5*	66	14,0	250	1
6190 1320	14 x 18	32		32,5*	66	14,0	250	1
6190 1340	14 x 18	34		32,5*	66	14,0	253	1
6190 1360	14 x 18	36		32,5*	74	15,0	245	1
6190 1380	14 x 18	38		32,5*	74	15,0	230	1
6190 1400	14 x 18	40		40,0*	82	15,0	315	1
6190 1410	14 x 18	41		40,0*	82	15,0	316	1



Ring End Insert Tools

- With pin lock
- *) = please consider the depth gauge (s) for correct calculation of the torque value

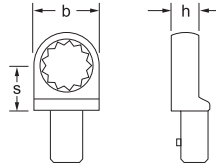

Art. Code	mm	mm	s mm	b mm	h mm	g	
6191 0070	9 x 12	7	17,5	13,0	8	38	1
6191 0080	9 x 12	8	17,5	14,2	8	37	1
6191 0100	9 x 12	10	17,5	17,2	9	40	1
6191 0110	9 x 12	11	17,5	18,5	9	42	1
6191 0120	9 x 12	12	17,5	20,0	12	51	1
6191 0130	9 x 12	13	17,5	21,5	12	51	1
6191 0140	9 x 12	14	17,5	23,0	12	53	1
6191 0160	9 x 12	16	17,5	25,7	13	56	1
6191 0170	9 x 12	17	17,5	27,2	13	55	1
6191 0180	9 x 12	18	17,5	28,5	13	60	1
6191 0190	9 x 12	19	17,5	30,3	13	64	1
6191 0210	9 x 12	21	17,5	33,0	15	68	1
6191 0220	9 x 12	22	17,5	34,5	15	71	1
6191 1130	14 x 18	13	25,0	21,5	11	130	1
6191 1140	14 x 18	14	25,0	23,0	11	132	1
6191 1160	14 x 18	16	25,0	25,7	12	137	1
6191 1170	14 x 18	17	25,0	27,2	12	141	1
6191 1180	14 x 18	18	25,0	28,5	12	139	1
6191 1190	14 x 18	19	25,0	30,5	12	145	1
6191 1210	14 x 18	21	25,0	33,0	15	152	1
6191 1220	14 x 18	22	25,0	34,5	15	157	1
6191 1240	14 x 18	24	25,0	37,5	15	162	1
6191 1270	14 x 18	27	31,0*	41,5	17	205	1
6191 1300	14 x 18	30	31,0*	45,0	19	205	1
6191 1320	14 x 18	32	31,0*	47,5	19	214	1
6191 1340	14 x 18	34	31,0*	50,5	19	226	1
6191 1360	14 x 18	36	31,0*	53,0	19	230	1
6191 1380	14 x 18	38	31,0*	53,0	19	230	1
6191 1410	14 x 18	41	31,0*	59,0	20	235	1



Flared Ring End Insert Tools

- With pin lock
- *) = please consider the depth gauge (s) for correct calculation of the torque value

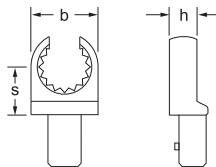

Art. Code	mm	mm	s mm	b mm	h mm	g	
6192 0100	9 x 12	10	17,5	21,0	11,0	40	1
6192 0110	9 x 12	11	17,5	22,5	11,0	40	1
6192 0120	9 x 12	12	17,5	23,7	11,0	40	1
6192 0130	9 x 12	13	17,5	25,2	11,0	40	1
6192 0140	9 x 12	14	17,5	27,0	12,0	50	1
6192 0170	9 x 12	17	17,5	31,5	12,0	65	1
6192 0180	9 x 12	18	17,5	33,0	14,5	65	1
6192 0190	9 x 12	19	17,5	34,5	14,5	65	1
6192 0220	9 x 12	22	20,0*	39,0	14,5	65	1

Assortments of Insert Tools.

All important insert tools in a solid metal case.



MTS MATADOR TOOL SYSTEM.

In robust metal case.

5 - 50 or 10 - 100 N-m.









■ Sets of Open End Insert Tools 9 x 12

- Sets with the most important open end insert tools with rectangular cavity in 9 x 12 mm
- With torque wrench and fine teeth insert reversible ratchet



MTS MATADOR TOOL SYSTEM.







Art. Code	l mm	b mm	g	
6190 9100 	445	185	1400	1
6190 9101 	445	185	1400	1
  6185				
  6186				
 6190 8 - 10 - 11 - 12 - 13 - 16 - 17 - 19 mm				

■ Sets of Ring End Insert Tools 9 x 12

- Sets with the most important ring end insert tools with rectangular cavity in 9 x 12 mm
- With torque wrench and fine teeth insert reversible ratchet







MTS MATADOR TOOL SYSTEM.

Art. Code	l mm	b mm	g	
6191 9100 	445	185	1400	1
6191 9101 	445	185	1400	1
  6185				
  6186				
 6191 8 - 10 - 11 - 12 - 13 - 16 - 17 - 19 mm				

■ Set of Insert Tools Basic 9 x 12

- Set with the most important open and ring end insert tools with rectangular cavity in 9 x 12 mm
- Without torque wrench
- With fine teeth insert reversible ratchet









Art. Code	l mm	b mm	g	
6194 9170 	445	185	1400	1
  6186				
 6190				8 - 10 - 11 - 12 - 13 - 16 - 17 - 19 mm
 6191				8 - 10 - 11 - 12 - 13 - 16 - 17 - 19 mm



MTS MATADOR TOOL SYSTEM.

■ Sets of Insert Tools Pro 9 x 12

- Set with the most important insert tools with rectangular cavity in 9 x 12 mm
- With torque wrench
- With fine teeth insert reversible ratchet





Art. Code	l mm	b mm	g	
6194 9180 	445	185	1350	1
6194 9181 	445	185	1400	1
  6185				5 - 50 N·m
  6186				10 - 100 N·m
 6190				8 - 10 - 11 - 12 - 13 - 16 - 17 - 19 mm
 6191				8 - 10 - 11 - 12 - 13 - 16 - 17 - 19 mm



MTS MATADOR TOOL SYSTEM.

■ Set of Open End Insert Tools 14 x 18

- Set with the most important open end insert tools with rectangular cavity in 14 x 18 mm
- With fine teeth insert reversible ratchet





Art. Code	l mm	b mm	g	
6190 9110 	445	185	1300	1
  6186				
 6190				13 - 16 - 17 - 19 - 21 - 22 - 24 - 27 - 30 - 32 mm



MTS MATADOR TOOL SYSTEM.

■ Set of Ring End Insert Tools 14 x 18

- Set with the most important ring end insert tools with rectangular cavity in 14 x 18 mm
- With fine teeth insert reversible ratchet

Art. Code	l mm	b mm	g	
6191 9110 	445	185	1300	1
  6186				
 6191				13 - 16 - 17 - 19 - 21 - 22 - 24 - 27 - 30 - 32 mm



MTS MATADOR TOOL SYSTEM.

High Output Torque = Low Input Torque x Revolution.

The function principle of a torque multiplier.



Why use a torque multiplier?

The longer a lever arm the higher the force action. But especially when it comes to industrial screw connections from a certain torque value onwards this basic physical principle is no longer practicable. In case of high torque values it is even no longer possible. For instance, a torque value of 9500 N·m / 7000 lbf·ft cannot be reached with a torque wrench in accordance with the lever rule which says that the distance to the fulcrum determines the rotational effect of the applied force.

Torque multipliers provide a remedy. They substitute the classic lever principle by the physical formula:

$$\text{Torque (Output)} = \text{Torque (Input)} \times \text{Revolution.}$$

It is thus the number of revolutions that determines the output torque, not the length of the lever.

Effective gearing as a standard.

Torque multipliers can be compared to adapters which multiply the applied force (= the input torque) with the help of a gear without having to use long lever arms. The multiplying effect depends on the gear ratio of the gear used.

MATADOR torque multipliers are equipped with high quality ball-bearing precision planetary gears that have an additional overload protection. Thanks to the effective gear ratio the desired output torque is easy to calculate and complicated correction tables are things of the past.

Torque multipliers are very robust and designed for continuous operation under industrial conditions. They should not be missing in any workshop.

Maximum power in the smallest of spaces.

Torque Multipliers are ideal for mobile application thanks to usage without any electronic or pneumatic support.

The main benefits are:

- ✓ Very high power application without long lever arms, use-able in most confined spaces
- ✓ Work with standard workshop torque wrenches, no hidden extra costs
- ✓ Effective gearing, specified gear ratio is the true factor for torque multiplication
- ✓ Lower priced and more variable in use than comparable torque wrenches
- ✓ From 4 500 N·m / 3 300 lbf·ft with anti-wind-up ratchet for safe working

Function example

Input torque = 300 N·m / 220 lbf·ft

Gear ratio 1:5

Output torque = 1500 N·m / 1100 lbf·ft

Based on a gear ratio of 1:5, 5 revolutions at the input (with an input torque of 300 N·m / 220 lbf·ft) are required in order to achieve 1500 N·m / 1100 lbf·ft as the output torque.

Input torque and output torque are regarded as constant, the power is only determined by the number of revolutions.

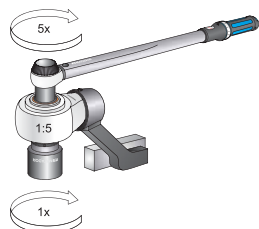

MATADOR Torque Multipliers. The solid compact class.

More power without long levers.

Heavy duty construction with planet gear mechanism with 3 precisely engineered gear stages and hardened gear wheels.

With reaction arm.



1.500 – 2.700 N·m
(1100 - 2,000 lbf·ft).



Including plug-in reaction foot



In solid plastic case

■ Torque Multipliers

- Perfect for applications where compact size and weight are critical or for mobile use
- For reducing the effort of applying high torque without electric or pneumatic devices
- Planet gear mechanism with 3 precisely engineered gear stages
- True 5:1 torque multiplication
- Multiplication accuracy according to DIN ISO 6789 / ASME B107.14M-1994 better than ±5%
- Supplied with 2 reaction styles for maximum versatility (reaction bar and plug-in reaction foot)
- In extremely sturdy plastic case

±5%

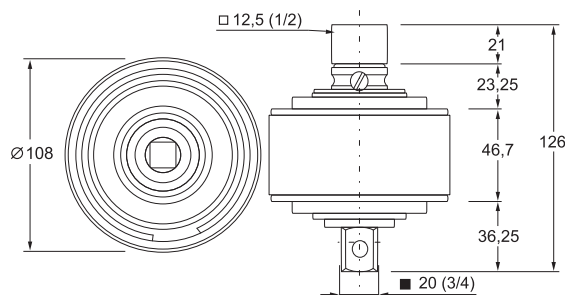

Art. Code	mm	"	mm	"	N-m	lbf-ft	Ratio	N-m	lbf-ft	mm	g	g	Box
6182 0010	20	3/4	12,5	1/2	1500	1100	1:5	300	220	108	3500	6480	1
6182 0020	25	1	12,5	1/2	2700	2000	1:5	540	400	108	4150	6480	1

Pneumatic Tools.

Be a MATADOR.



Content Pneumatic Tools.

Page Article group

	Impact Wrenches.
113	Impact Wrench 12.5 mm (1/2")
113	Impact Wrenches 20 mm (3/4") and 25 mm (1")
114	Impact Wrenches 12.5 mm (1/2") „MiniMAX“
115	Impact Wrenches 25 mm (1") „FatCat“

	Miscellaneous Air Tools.
116	Mini Ratchet Wrench 6.3 mm (1/4")
117	Die Grinder, straight
117	Micro Die Grinder
118	Air Duster

	Accessories.
119	Precision Oiler
119	Mini Grease Oil
119	Oil Regulator
119	PU compressed air spiral coiled tube
120	Quick Coupler with male thread
120	Male Coupler with male thread
120	Quick Coupler with female thread
120	Male Coupler with female thread
121	Quick Coupler with hose connector
121	Male Coupling with hose connector
121	Reducing Nipple
121	Reducing Nipple
122	Hose Nipple with Male Thread
122	Compressed Air 3-way Separator
122	Compressed Air Regulator
122	Metal Swivel Joint
123	Padded ear defenders
123	Micro fine woven gloves
123	Protecting Glasses

Page Article group

	Impact Tools 12.5 (1/2).
125	Impact Sockets
125	Impact Socket Set, 14 pcs.
126	Impact Sockets, long type
126	Impact Socket Set, 13 pcs.
127	Impact Screwdriver Bit Sockets (Hexagon)
127	Impact Screwdriver Bit Socket Set, 6 pcs.
127	Impact Screwdriver Bit Sockets (XZN)
128	Impact Screwdriver Bit Socket Set, 6 pcs.
128	Impact Screwdriver Bit Sockets (TORX*)
128	Impact Screwdriver Bit Socket Set, 6 pcs.
129	Impact Screwdriver Bit Sockets (TORX*)
129	Impact Screwdriver Bit Socket Set, 9 pcs.
129	Impact Extension
130	Impact Universal Joint
130	Impact Reducer
130	Impact Converter
130	Safety Rings and Safety Pins

	Impact Tools 20 (3/4).
131	Impact Sockets
131	Impact Socket Set, 17 pcs.
132	Impact Sockets, long type
132	Impact Screwdriver Bit Sockets (TORX*)
133	Impact Screwdriver Bit Sockets (Hexagon)
133	Impact Extensions
133	Impact Universal Joint
134	Impact Reducer
134	Impact Converter
134	Safety Rings and Safety Pins

Page Article group

	Impact Tools 25 (1).
135	Impact Sockets
136	Impact Sockets, long type
136	Impact Extensions
137	Impact Universal Joint
137	Impact Reducer
137	Impact Converter
137	Safety Rings and Safety Pins



MATADOR Pneumatic Tools. Powered screw tightening. At a push.



Professionals work with compressed air.

Certainly screws can be tightened or untightened with a simple reversible ratchet. But everybody who had to tighten more than 5-10 screws one after another knows the problem: It is an arduous task.

This work is done much faster and more safely with machine-driven sockets and operating tools.

For industrial application mainly pneumatic tools are used because of their higher performance and compact design. Electric tools are only rarely used in this field.

Compressed air motors have proven themselves as a solution for numerous drive-related requirements. Their solidity and durability as well as only little efforts in terms of assembly, installation and maintenance speak for themselves.

High peak torque and easy tightening.

Impact wrenches operate by a spinning motor that delivers a shock of power to a lug nut. This shock loosens and turns the nut very quickly. The hammer mechanism is designed such that after delivering the impact, the hammer is again allowed to spin freely, and does not stay locked.

This is an advantage which cannot be provided by electrical tools and which is especially helpful for untightening stuck screws.

Thanks to the adjustable torque limitation also during tightening operation power can be applied in a controlled manner.

When used correctly over-twisted screws are a thing of the past. And the final rotation should always be done with a torque wrench.

The MATADOR quality promise.

There are many different kinds of pneumatic tools but often the quality is not very reliable.

MATADOR pneumatic tools do not only provide excellent technical features but also a durable quality designed for industrial use.

We have set-up a range of pneumatic tools that have been tried and tested thoroughly by our technicians and that cover the most important fields of application. True to the motto: Quality before quantity.



The MATADOR service.

MATADOR pneumatic tools are designed for a long life and high reliability – provided that they are handled with the right care.

In case of an unplanned need of repairs or for maintenance reasons our service technicians help you in a quick and unbureaucratic way: In our own workshop in Remscheid we stock an extensive program of spare parts and are able to conduct repairs and maintenance quickly and reasonably priced.

As a standard with each item we provide an exploded drawing and a spare parts list to help you find the suitable parts in case you want to help yourself.

Our service does not end after sales – promise!

Impact technology in a nutshell.

Not only hot air -
with the right care.



Sample installation with maintenance unit:

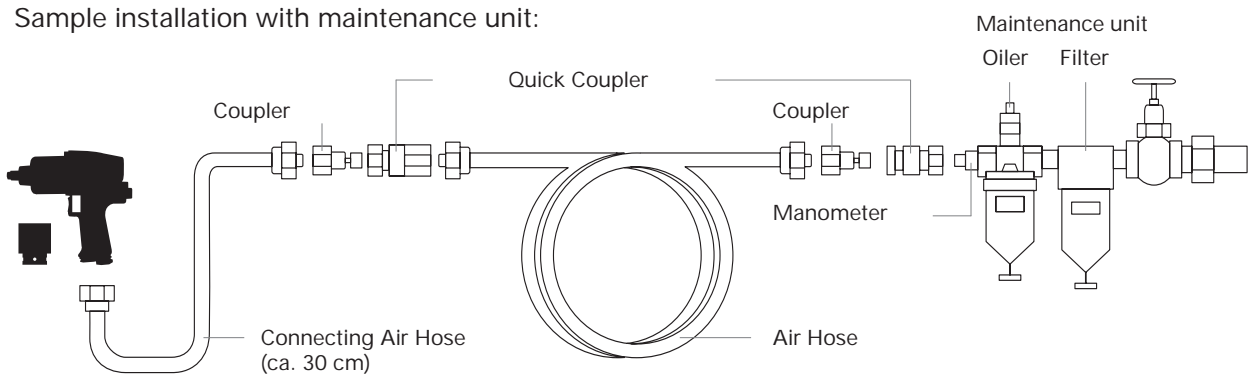

Air pressure:
6.3 bar (90 psi).



The ideal air
volume.

Right Lubrication is the
most important issue.

Only with
maintenance unit.

The performance of your impact tool depends essentially on the ideal air inlet pressure.

Air inlet pressures that are too high will lead to excessive wear and failure of the tool after a while. Tools operating with too low air pressure are usually lacking in their full performance.



The ideal pressure of the supplied air should be 6.3 bar (90 psi) at the air entrance of the air tool (also when air is flowing). Only with ideal air pressure the impact tool will achieve the technical properties as defined in the respective manual.

To reach the ideal performance of the impact tool the perfect air volume depends on many factors:

The maximum air consumption values for the relevant impact tool (l/min or CFM), the recommended hose sizes (inner diameter), the maximum flow rates of the maintenance unit and the effective capacity of the compressor must be balanced.

The recommended hose size is indicated in the MATADOR manuals and catalogues.

As a rough guide please use:

		
l/min	CFM	mm
100-190	4-6	6-9
195-300	7-10	13

The consequent lubrication of air motors is absolutely required to maintain full performance of the motor, to prolong the life time of the motor and to prevent corrosion.

If you don't use a maintenance unit or an additional oiler, the impact tool should be lubricated manually every day before use.

In this case decouple the impact tool from the quick coupler and trickle approx. 5 ml of a suitable air motor oil into the hose. As a rough guide use 1-2 drops of oil per cubic meter compressed air.

After this reconnect the impact tool with the air supply and run the motor for a few seconds at a slow rate in order to homogeneously distribute the oil in the drive.

The reliability and durability of an impact tool can significantly be improved by the assembly of a maintenance unit.

MATADOR recommends to install a maintenance unit on each workplace consisting of manometer, lubricator and water separator.

The water separators and filters which are integrated in our maintenance units avoid corrosion in air motors and supply clean air. A high content of water in the compressed air will lead to rust inside which means air pressure losses and a lack of performance of the air tools.

If no filters are used, rust and particles will damage or block the motor.

Still working when others have long given up. MATADOR Impact Wrenches with composite housing. Maximum performance at low weight.

Ultra light composite housing.



High performance Twin Hammer Clutch Mechanism with 2 anvils with a newly developed Twin Line driver to create an enormous breakaway torque already within the first rotations of the engine.



With one-hand switchover.

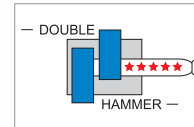

Non-slip handle.

Extremely low air consumption, e.g. only 113 l/min with 12.5 (1/2") drive.

Exhaust air guided downwards through the handle.



The Double Hammer principle. Superior technique for heavy duty application.



High-performance Twin Hammer Clutch Mechanism



One-hand forward/reverse shift through practical push button

What really matters.

Five factors determine the performance of impact wrenches. We at MATADOR have attached great importance to these:

- High loosening torque (so that fixed screw joints can be loosened powerfully)
- Constant, reliable impact through twin hammer clutch mechanisms
- Low weight for less fatiguing operation, in best case through composite housing
- Low air consumption
- Low-maintenance and robust construction

MATADOR impact wrenches use only top class twin hammer clutch mechanisms, also in (3/4") and 25 (1") class tools. Compared to simple pin clutch mechanisms these twin clutch hammers are more robust, consist of only few single parts (i.e. less wear parts) and provide a reliable, constant impact with uncontinuous torque progression.

Superior quality at a reasonable price.

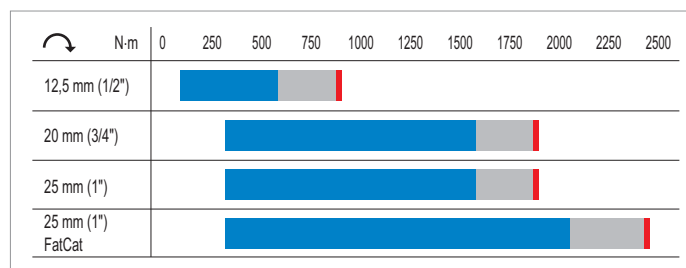

3 performance classes from 813 - 2441 maximum torque (N·m)

■ Impact Wrench 12.5 mm (1/2")

1/2 12.5 mm

- High-performance impact wrench with excellent technical features
- Enormous 1.490 N-m max. loosening torque
- Only 83 dB(A) sound pressure level
- Only 1.9 kg in weight (composite housing)
- Cold-insulated handle
- Extremely low vibration, ideal for continuous operation
- With high-performance twin hammer clutch mechanism with 6-blades rotor
- Including coupler

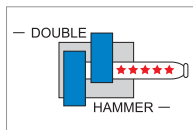

	Maximum loosening torque	N-m ft-lbs	1490 1100
	Maximum torque	N-m ft-lbs	813 600
	Recommended torque	N-m ft-lbs	68-542 50-400
	Sound pressure level	dB(A)	83
	Idle speed	U/min rpm	7000
	Air consumption	l/min CFM	113 4
	Operating pressure	bar psi	6,3 90
	Air inlet thread	IG mm NPT "	11,8 1/4
	Recommended hose size	mm "	10 3/8



Art. Code	mm	"	mm	g	
7000 0001	12,5	1/2	183	1900	1

■ Impact Wrenches 20 mm (3/4") and 25 mm (1")

1 25 mm 3/4 20 mm

- High-performance impact wrench with excellent technical features
- Enormous 2.645 N-m max. loosening torque
- Only 90 dB(A) sound pressure level
- Only 3.4 and 3.5 kg in weight (composite housing)
- With twin hammer clutch mechanism
- Cold-insulated handle
- Extremely low vibration, ideal for continuous operation
- With high-performance twin hammer clutch mechanism with 6-blades rotor
- Including coupler

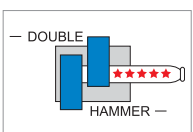

	Maximum loosening torque	N-m ft-lbs	2645 1950
	Maximum torque	N-m ft-lbs	1898 1400
	Recommended torque	N-m ft-lbs	271-1627 200-1200
	Sound pressure level	dB(A)	90
	Idle speed	U/min rpm	5500
	Air consumption	l/min CFM	198 7
	Operating pressure	bar psi	6,3 90
	Air inlet thread	IG mm NPT "	15,25 3/8
	Recommended hose size	mm "	13 1/2



Art. Code	mm	"	mm	g	
7000 0002	20	3/4	215	3300	1
7000 0003	25	1	223	3400	1

MATADOR MiniMAX. Powerful 1.275 Nm. Only 1,27 kg. Only 94 dB(A). High-performance meets handiness.

Extremely powerful
Jumbo hammer clutch.

With one-hand switchover.

- EXTREMELY LOW NOISE.
- EXTREMELY LIGHT.
- EXTREMELY POWERFUL.



Ultra light composite housing.

Cold-insulated, non-slip handle.

Exhaust air.

Including coupler.

Impact Wrenches 12,5 (1/2) „MiniMAX“

1/2 12.5 mm



	Maximum loosening torque	N-m ft-lbs	1275 940
	Maximum torque	N-m ft-lbs	678 500
	Recommended torque	N-m ft-lbs	68-746 50-550
	Sound pressure level	dB(A)	94
	Idle speed	U/min rpm	10000
	Air consumption	l/min CFM	113 4
	Operating pressure	bar psi	6,3 90
	Air inlet thread	IG mm NPT *	11,8 1/4
	Recommended hose size	mm "	10 (3/8)

- High-performance impact wrench with outstanding technical features
- Extremely small (only 98 mm length)
- extremely powerful 1.275 N-m loosening torque
- Only 94 dB(A) sound pressure level
- Jumbohammer clutch
- Ultra light 1,2 kg weight (composite housing)
- One-hand switchover
- Extremely low vibration, ideal for continuous operation
- Exhaust air guided downwards through the handle
- Including coupler

Art. Code	mm	"	mm	g	
7000 0011	12,5	1/2	98	1270	1

MATADOR FatCat. Powerful 2.440 Nm. Only 7.3 kg. Only 96 dB(A). Maximum performance at low weight.

High-performance twin hammer clutch mechanism with 2 anvils with a newly developed high-end Twin Line driver. For higher loosening torque already within the first engine rotations.

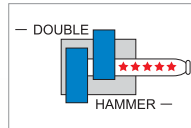

Including anvil
185 mm (7.3").



Side support handle for less fatiguing operation.

Rear exhaust.

Multiple power settings in forward and reverse.

2 air inlets (downwards and sideways/backwards).

Impact Wrenches 25 mm (1") „FatCat“

1 25 mm

	Maximum loosening torque	N-m ft-lbs	3389 2500
	Maximum torque	N-m ft-lbs	2441 1800
	Recommended torque	N-m ft-lbs	271-2033 200-1500
	Sound pressure level	dB(A)	96
	Idle speed	U/min rpm	6000
	Air consumption	l/min CFM	282 10
	Operating pressure	bar psi	6,3 90
	Air inlet thread	IG mm NPT "	19 1/2
	Recommended hose size	mm "	13

- High Impact Wrench with outstanding technical properties
- With twin hammer impact mechanism with 6-vane motor
- Enormous 3.389 N-m maximum release torque
- Only 96 dB (A) sound pressure level
- Only 7.3 kg weight (composite housing)
- Includes spindle 185 mm (7.3")
- Complete with side handle with mounting kit
- Includes coupler plug



Supply air can be guided downwards or backwards



Art. Code	mm	"	mm	g	
7000 0004	25	1	324	7300	1

Ratchet Wrenches with especially low air consumption. For constant impact.

Small. Handy. Resilient.

Anti-deformation ratchet head for extra stability and better power transmission.

Power regulator for variable adjustment of speed and performance depending on the application.

Ultra lightweight housing.



High-performance pin clutch impact mechanism for continuous torque progression - saves your knuckles.



■ Mini Ratchet Wrench 6.3 mm (1/4")

1/4 **6.3**
mm



	Maximum loosening torque	N-m ft-lbs	27 20
	Recommended torque	N-m ft-lbs	7-27 5-20
	Sound pressure level	dB(A)	79
	Idle speed	U/min rpm	200
	Air consumption	l/min CFM	113 4
	Operating pressure	bar psi	6,3 90
	Air inlet thread	IG mm NPT "	11,8 1/4
	Recommended hose size	mm "	10 3/8







- High-performance pin clutch impact mechanism for continuous torque progression - saves your knuckles
- 3x faster than standard ratchets
- Very small and handy, only 177 mm in length
- Only 79 dB(A) sound pressure level
- With continuous power regulator for variable speed adjustment depending on the case of application
- Cushioned grip, low vibration
- Cold-insulated handle, suitable for outside work and continuous operation
- Forward/reverse
- Exhaust air is guided downwards through the handle (rotating exhaust)
- Including coupler







Art. Code	mm	"	mm	g	
7001 0001	6,3	1/4	177	500	1

Micro Die Grinder

- For work in confined spaces
- Very handy and slim design
- Ideal for grinding, polishing and deburring
- For HM mills, mini cutting discs and grinding heads with a 3 mm (1/8") shaft
- Low noise, only 79 dB(A) sound pressure level
- With continuous power regulator for variable speed adjustment depending on the case of application
- Cushioned grip, low vibration
- Cold-insulated handle, suitable for outside work and continuous operation
- Forward/reverse
- Exhaust air is guided downwards through the handle (rotating exhaust)
- Including coupler







	Sound pressure level	dB(A)	79
	Idle speed	U/min rpm	56000
	Air consumption	l/min CFM	113 4
	Operating pressure	bar psi	6,3 90
	Air inlet thread	IG mm NPT *	11,8 1/4
	Recommended hose size	mm "	10 3/8



					
Art. Code	mm	"	mm	g	
7004 0002	3,0	1/8	132	400	1



Die Grinder, straight

	Sound pressure level	dB(A)	79
	Idle speed	U/min rpm	20000
	Air consumption	l/min CFM	113 4
	Operating pressure	bar psi	6,3 90
	Air inlet thread	IG mm NPT *	11,8 1/4
	Recommended hose size	mm "	10 3/8

- Ideal for grinding, polishing and deburring
- For HM mills, mini cutting discs and grinding heads with a 6 mm (1/4") shaft
- Only 0.7 kg in weight
- Low noise, only 79 dB(A) sound pressure level
- With continuous power regulator for variable speed adjustment depending on the case of application
- Cushioned grip, low vibration
- Cold-insulated handle, suitable for outside work and continuous operation
- Forward/reverse
- Exhaust air is guided downwards through the handle (rotating exhaust)
- Including coupler



					
Art. Code	mm	"	mm	g	
7004 0001	6,3	1/4	188	700	1



The MATADOR Air Duster.







For cleaning and removing of swarfs and other particles.



■ Air Duster

- For cleaning and removing of swarfs and other particles, especially in confined spaces
- Anti-slip handle made of special plastic
- Steel nozzle
- Adjustable air volume
- With hanging hole
- Can be connected directly to air coupling



	Sound pressure level	dB(A)	85-90
	Idle speed	U/min rpm	15 220
	Air consumption	l/min CFM	300
	Operating pressure	bar psi	5-8 75-120
	Air inlet thread	IG mm NPT *	11,8 1/4
	Recommended hose size	mm "	10 3/8

	Art. Code			
	7003 0001	mm	g	
		130	100	1

■ Precision Oiler

- Very practical - for any kind of application
- Allows precise oil delivery, one drop at a time
- With push button on the end to control the flow of oil from the tip
- Complete with screw-on cover and pocket clip
- Light aluminium housing

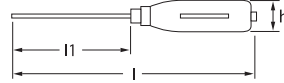

Art. Code	d mm	l mm	l1 mm	g	
0793 0002	15	140	50	50	1

■ Mini Grease Oil

- For the lubrication of impact tools
- With lockable nozzle
- Contents: 100 ml

Art. Code	g
7005 0002	250



■ Oil Regulator

- For automatic oiling of impact tools
- Assembly directly in the access direction
- Refillable

Art. Code	"	l mm	g
7005 0014	1/4	54	110

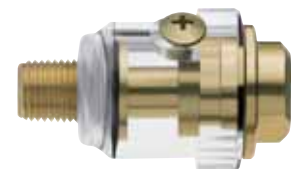

■ PU compressed air spiral coiled tube

- Flexible, crush resistant polyurethane hose (PU)
- Tube ends with anti kink device
- Rotating fitting
- Flexible in cold
- Oil and petrol resistant
- Max. 12 bar / 174 psi

Art. Code	OW	mm	l m	g
7005 0005	6	10	8	600



■ Quick Coupler with male thread



- For one handed operation
- Non return valve
- Self sealing on the coupling
- Spanner Size 22

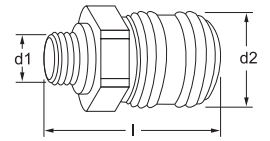

Art. Code	d2 *	mm	l mm	d1 mm	g	
7005 0101	1/4	22	35	22	70	1
7005 0102	3/8	22	36	22	90	1
7005 0103	1/2	22	38	22	90	1

■ Male Coupler with male thread

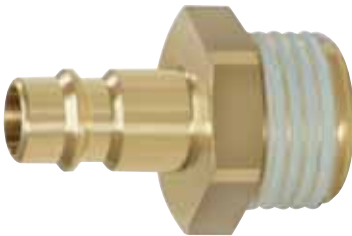

- Spanner Size 17, 19, 24
- Material: Brass

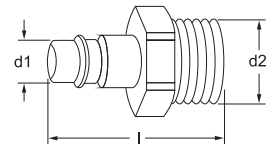

Art. Code	d2 *	mm	l mm	d1 mm	g	
7005 0111	1/4	17	33	10	20	1
7005 0112	3/8	19	33	10	25	1
7005 0113	1/2	22	33	10	30	1

■ Quick Coupler with female thread



- For one handed operation
- Non return valve
- Self sealing on the coupling
- Spanner Size 22, 24

- Material: Brass

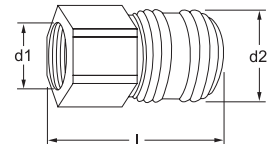

Art. Code	d2 *	mm	l mm	d1 mm	g	
7005 0201	1/4	22	41	22	80	1
7005 0202	3/8	22	41	22	85	1
7005 0203	1/2	22	41	22	90	1

■ Male Coupler with female thread



- Spanner Size 17, 19, 24
- Material: Brass

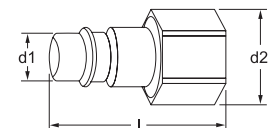

Art. Code	d2 *	mm	l mm	d1 mm	g	
7005 0211	1/4	17	33	10	20	1
7005 0212	3/8	19	33	10	30	1
7005 0213	1/2	22	35	10	40	1

Quick Coupler with hose connector

- For one handed operation
- Roller latch
- Non return valve
- Spanner Size 21

- Material: Brass

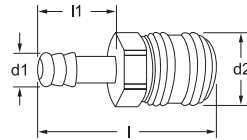

Art. Code	mm	mm	l mm	l1 mm	d1 mm	d2 mm	g
7005 0301	6	21	55	23	7	26	70
7005 0302	9	21	55	24	10	26	80
7005 0303	13	21	55	25	14	26	90

Male Coupling with hose connector

- For hoses with diameter 6-13 mm
- Material: Brass

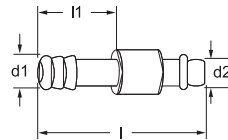

Art. Code	mm	l mm	l1 mm	d1 mm	d2 mm	g
7005 0401	6	44	23	7	10	10
7005 0402	9	44	23	10	10	20
7005 0403	13	46	23	14	10	25

Reducing Nipple

- Spanner Sizes: 19, 24 mm
- Material: Brass

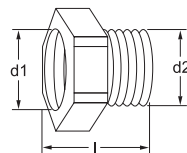

Art. Code	d1 "	d2 "	mm	l mm	g
7005 0501	1/4	3/8	19	14	10
7005 0502	1/4	1/2	19	26	30
7005 0503	3/8	1/2	24	26	50
7005 0504	1/2	3/4	24	26	50

Reducing Nipple

- Spanner Sizes: 17, 19, 24 mm
- Max.: 12 bar
- Material: Brass

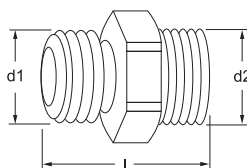

Art. Code	d1 "	d2 "	mm	l mm	g
7005 0511	1/4	1/4	17	14	10
7005 0513	3/8	3/8	19	26	50
7005 0515	1/2	1/2	24	18	60

■ Hose Nipple with Male Thread

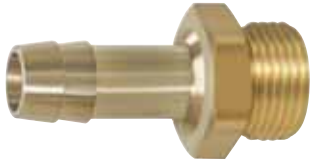

– Spanner Sizes: 17, 19, 24 mm

– Material: Brass

Art. Code	"	mm	mm	l mm	g	
7005 0601	1/4	6	17	36	20	1
7005 0602	1/4	9	17	36	20	1
7005 0603	3/8	9	19	36	30	1
7005 0604	3/8	13	19	40	30	1
7005 0605	1/2	9	24	42	50	1
7005 0606	1/2	13	24	46	50	1

■ Compressed Air 3-way Separator



– Connection of 3 departure directions

– Material: Brass

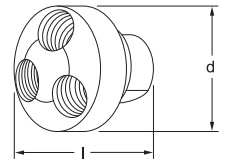

Art. Code	"	mm	d mm	l mm	g	
7005 0701	1/4	19	41	32	160	1

■ Compressed Air Regulator



– For regulating the air flow volume

– Material: Brass

– With regulation wheel

– Assembly directly in the access direction

– Completely lockable

– Spanner size: 18 mm

– Max. 14.5 bar

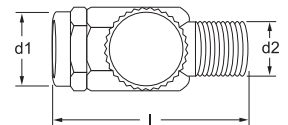

Art. Code	d1 "	d2 "	mm	l mm	g	
7005 0801	1/4	1/4	18	43	80	1

■ Metal Swivel Joint



– Prevents damages of the compressed air tube by swivel head (360°)

– With compressed air regulator

– Spanner size: 16 mm

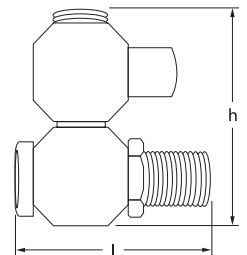

– Material: Metall



Art. Code	"	mm	l mm	d1 mm	g	
7005 0802	1/4	16	35	36	80	1

■ Padded ear defenders

- According to CE / EN 352-1
- With adjustable and padded ear shells for comfortable wear
- Ear shells with stepless fast adjustment
- Sound level reduction: 25 dB(A)

				
Art. Code			g	
7100 0001			200	1



■ Micro fine woven gloves



- According to CE / EN 420 / 388
- Very comfortable design and fit
- Especially breathable fabric
- With PU reinforced gripping palm
- Ideal for working with small parts
- Silicone-free, also suitable for allergy sufferer
- 12 pair / box

				
Art. Code			g	
7110 0001	L	8	10	1
7110 0002	XL	9	20	1
7110 0003	XXL	10	25	1



■ Protecting Glasses

- Clear glasses
- With UV protection
- Sportive design
- Extremely substantial frame
- Polycarbonate lens

				
Art. Code			g	
7120 0001			30	1



■ Protecting Glasses

- According to EN 166
- Practical for spectacle wearers
- With ventilation holes for clear visibility
- With firm frame
- With ear clip
- Polycarbonate lens

				
Art. Code			g	
7121 0001			75	1



MATADOR Impact Tools. For quick and safe application. For machine-operated use.

Made of Chrome-Molybdenum special steel for high resilience and minimal wear.

Manganese phosphated surface for high level of corrosion protection.

With end-to-end hole for the safety pin and with groove for the safety ring according to DIN 3129.



According to international standards: DIN 3129, ISO 2725-2, BS 7794, AMSE B107.2.

With MATADOR SmartDrive² Profile: Optimized traction. Better torque transmission. Better protection of tool and screw.



Never confuse hand operation and machine operation.

Sockets are distinguished according to their way of operation, i.e. hand operation or machine operation.

Sockets for hand operation are not suitable for the use with electric or air tools whereas impact sockets can also be used in hand-operation (e.g. for controlled tightening with the help of a torque wrench).

We repeatedly receive claims because sockets that are only suitable for hand-operation were instead used with impact wrenches. As a result they cracked.

Sockets that are suitable for machine operation are made of a special high-performance steel, are thick-walled and coated in another way than standard sockets.



More strength through Molybdenum alloy.

Through adding Molybdenum impact sockets reach a higher yield strength and solidity than standard sockets made of Chrome Vanadium steel. Also Molybdenum increases the corrosion resistance of the tools.

Impact sockets for machine operation must not be nickel-plated and chrome-plated like hand-operated sockets. As they are exposed to considerable force chrome can peel off and cause injuries.

In a special treatment process MATADOR impact sockets are thus manganese phosphated. The manganese surface acts as a protective shield. It reduces wear of the tools and thus increases their durability.

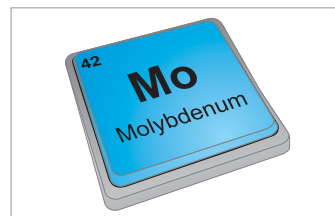

Superior surface thanks to manganese phosphating.

For surface treatment MATADOR uses a special manganese phosphate solution. Together with Chrome-Molybdenum it causes a chemical reaction during which it covers the surface of the metal. During this process a protective coating is created.

The phosphate coating protects the metal against abrasion and heat and as a result reduces the wear of the tools. Even if exposed to heavy load the phosphate coating remains.

Impact sockets with manganese phosphated surface are can longer be used and are more durable than uncoated tools or tools that are or only black-finished (i.e. simply colored).

MATADOR impact sockets. Quality in detail.



The correct use of impact sockets.

According to DIN 3129 impact sockets must have a hole for the safety pin and a groove for the safety ring. A simple ball lock is not sufficient and is not permissible.

During machine operation heavy forces can occur. Without proper security operating tool and socket can easily separate and cause considerable damage.

For this reason MATADOR impact sockets do not have ball lock but have to be secured with pin and ring according to DIN 3129.

The correct size of the safety pin and safety ring depends on the size of the square drive of the socket. At the end of each tool segment you will find the suitable pins and rings.

To apply safety pin and ring is really easy and not at all time-consuming:

Simply connect socket and operating tool, insert the pin and secure with the ring.

Done. For your safety.

Impact Sockets



- Suitable for all standard electric and air tools
- With square drive as per DIN 3121 - G 12.5 / ISO 1174
- Suitable for hexagon head screws
- With 6-point profile
- With MATADOR SmartDrive Profile

- Standards: DIN 3129 / ISO 2725-2
- Material: Chrome-Molybdenum
- Finish: black phosphated

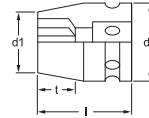

Art. Code	mm	t mm	l mm	d1 mm	d2 mm	g	
7475 0100	10	12	38	17,0	25	80	10
7475 0110	11	13	38	18,5	25	80	10
7475 0120	12	14	38	20,0	25	80	10
7475 0130	13	14	38	21,0	25	80	10
7475 0140	14	14	38	22,5	25	80	10
7475 0150	15	16	38	23,0	30	80	10
7475 0160	16	16	38	25,0	30	90	10
7475 0170	17	17	38	26,0	30	100	10
7475 0180	18	18	38	27,3	30	110	10
7475 0190	19	20	38	28,5	30	130	10
7475 0200	20	20	38	30,0	30	135	10
7475 0210	21	22	38	30,0	30	140	10
7475 0220	22	22	38	32,0	30	150	10
7475 0240	24	24	38	34,0	30	180	10
7475 0270	27	27	42	38,0	30	200	10
7475 0300	30	30	42	42,0	30	240	5
7475 0320	32	32	44	44,0	30	260	5
7475 0330	33	33	44	46,0	30	310	5
7475 0340	34	34	44	46,0	30	320	5

Impact Socket Set, 14 pcs.



- Set including the most common impact sockets
- With square drive as per DIN 3121 - G 12.5 / ISO 1174
- Suitable for hexagon head screws
- With 6-point profile
- With MATADOR SmartDrive Profile
- Including compatible safety rings and pins
- With MTS soft foam inlay
- In robust metal case



Art. Code	g	
7475 9001	1300	1
7475	10 - 11 - 13 - 14 - 15 - 17 - 19 - 21 - 22 - 24 mm	
7499	1x 10-14 - 1x 15-32 1x 10-14 - 1x 15-32	

METAL

Impact Sockets, long type



- Suitable for all standard electric and air tools
- With square drive as per DIN 3121 - G 12.5 / ISO 1174
- Suitable for hexagon head screws
- With 6-point profile
- With MATADOR SmartDrive Profile

- Standards: DIN 3129 / ISO 2725-2
- Material: Chrome-Molybdenum
- Finish: black phosphated

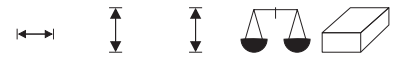

Art. Code	mm	l mm	d1 mm	d2 mm	g
7481 0100	10	78,0	17,5	24	125
7481 0110	11	78,0	18,5	24	125
7481 0120	12	78,0	19,5	24	135
7481 0130	13	78,0	20,5	24	135
7481 0140	14	78,0	22,0	24	140
7481 0150	15	78,0	24,0	24	145
7481 0160	16	78,0	24,0	24	170
7481 0170	17	78,0	26,0	26	180
7481 0180	18	78,0	28,0	28	185
7481 0190	19	78,0	28,0	28	195
7481 0200	20	78,0	30,0	30	220
7481 0210	21	78,0	30,0	30	220
7481 0220	22	78,0	32,0	30	240
7481 0240	24	78,0	34,0	30	260
7481 0270	27	78,0	38,0	30	300
7481 0300	30	78,0	42,0	30	360
7481 0320	32	78,0	44,0	30	400
7481 0330	33	78,0	46,0	30	440
7481 0340	34	78,0	46,0	30	480

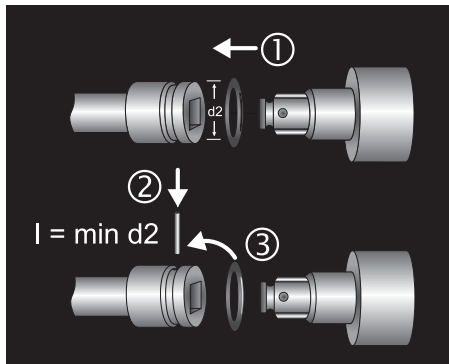

Assignment of impact tools and retaining rings and pins

Impact Socket Set, 13 pcs.



- Set including the most common impact -sockets, long type
- With square drive as per DIN 3121 - G 12.5 / ISO 1174
- Suitable for hexagon head screws
- With 6-point profile
- With MATADOR SmartDrive Profile
- Including compatible safety rings and pins
- With MTS soft foam inlay
- In robust metal case



Art. Code	g
7481 9001	2100
7481	0 - 13 - 15 - 17 - 18 - 19 21 - 22 - 24 mm
7499	1x 10-14 - 1x 15-32 1x 10-14 - 1x 15-32

METAL

Impact Screwdriver Bit Sockets (Hexagon)



- Suitable for all standard electric and air tools
- Material: Chrome-Molybdenum
- With square drive as per DIN 3121 - G 12.5 / ISO 1174
- Finish: black phosphated
- Suitable for in-hex screws

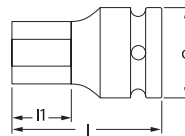

Art. Code	mm	l mm	l1 mm	d mm	g
7478 0050	5	78	45	25	75
7478 0060	6	78	45	25	80
7478 0080	8	78	45	25	85
7478 0100	10	78	45	25	100
7478 0120	12	78	45	25	115
7478 0140	14	78	45	25	135
7478 0170	17	78	45	25	205
7478 0190	19	78	45	25	240

Impact Screwdriver Bit Socket Set, 6 pcs.



- Suitable for all standard electric and air tools
- Suitable for in-hex screws
- With square drive as per DIN 3121 - G 12.5 / ISO 1174
- With MTS soft foam inlay
- In robust metal case



Art. Code	g
7478 9001 6 MM	700

7478 6 - 8 - 10 - 12 - 14 - 17 mm



Impact Screwdriver Bit Sockets (XZN)



- Suitable for all standard electric and air tools
- Material: Chrome-Molybdenum
- With square drive as per DIN 3121 - G 12.5 / ISO 1174
- Finish: black phosphated
- Suitable for multi-point screws XZN

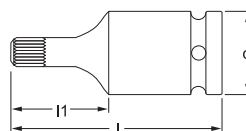

Art. Code	l mm	l1 mm	d mm	g
7479 0060 M6	78	45	25	75
7479 0080 M8	78	45	25	85
7479 0100 M10	78	45	25	95
7479 0120 M12	78	45	25	100
7479 0140 M14	78	45	25	110
7479 0160 M16	78	45	25	120



■ Impact Screwdriver Bit Socket Set, 6 pcs.



- Suitable for all standard electric and air tools
- With MTS soft foam inlay
- With square drive as per DIN 3121 - G 12.5 / ISO 1174
- In robust metal case
- Suitable for multi-point screws XZN

Art. Code	g	
7479 9001	900	1
	7479 M6 - M8 - M10 - M12 - M14 - M16	

■ Impact Screwdriver Bit Sockets (TORX[®])



- Suitable for all standard electric and air tools
- Material: Chrome-Molybdenum
- With square drive as per DIN 3121 - G 12.5 / ISO 1174
- Finish: black phosphated
- Suitable for protruding TORX[®] head screws

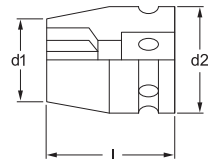

Art. Code		l1 mm	d1 mm	d2 mm	g	
7490 0100	E10	38	13,5	25	62	10
7490 0120	E12	38	15,5	25	62	10
7490 0140	E14	38	17,5	25	70	10
7490 0160	E16	38	19,6	25	74	10
7490 0180	E18	38	21,8	30	108	10
7490 0200	E20	38	23,8	30	116	10
7490 0240	E24	38	28,3	30	148	10

■ Impact Screwdriver Bit Socket Set, 6 pcs.



- Suitable for all standard electric and air tools
- With MTS soft foam inlay
- With square drive as per DIN 3121 - G 12.5 / ISO 1174
- In robust metal case
- Suitable for protruding TORX[®] head screws

Art. Code	g	
7490 9001	900	1
	7490 E10 - E12 - E14 - E18 - E20 - E24	

Impact Screwdriver Bit Sockets (TORX®)



- Suitable for all standard electric and air tools
- Material: Chrome-Molybdenum
- With square drive as per DIN 3121 - G 12.5 / ISO 1174
- Finish: black phosphated
- Suitable for recessed TORX® head screws

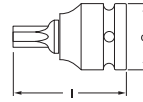

Art. Code	l mm	d mm	g	
7492 0250 T25	75	25	75	10
7492 0270 T27	75	25	75	10
7492 0300 T30	75	25	83	10
7492 0400 T40	75	25	84	10
7492 0450 T45	75	25	85	10
7492 0500 T50	75	25	88	10
7492 0550 T55	75	25	103	10
7492 0600 T60	75	25	116	10
7492 0700 T70	75	25	135	10



Impact Screwdriver Bit Socket Set, 9 pcs.



- Suitable for all standard electric and air tools
- With MTS soft foam inlay
- With square drive as per DIN 3121 - G 12.5 / ISO 1174
- In robust metal case
- Suitable for recessed TORX® head screws



Art. Code	g	
7492 9001	1100	1

T25 - T27 - T30 - T40 - T45 - T50 - T55 - T60 - T70



Impact Extension



- For machine-operated sockets and adapters
- Material: Chrome-Molybdenum
- With square drive as per DIN 3121 - G 12.5 and F 12.5 / ISO 1174
- Finish: black phosphated

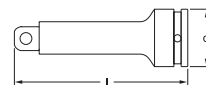

Art. Code	mm	"	mm	"	l mm	l "	d mm	g	
7465 0001	12.5	1/2	12.5	1/2	75	3	25	90	5
7465 0002	12.5	1/2	12.5	1/2	125	5	25	220	5
7465 0003	12.5	1/2	12.5	1/2	250	10	25	440	5



■ Impact Universal Joint



- For machine-operated sockets and adapters
- With square drive as per DIN 3121 - G 12.5 and F 12.5 / ISO 1174

- Material: Chrome-Molybdenum
- Finish: black phosphated

1/2 **12,5 mm** **1/2** **12,5 mm**

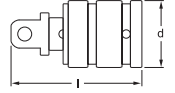

Art. Code	mm	"	mm	"	l mm	d mm	g	
7458 0001	12,5	1/2	12,5	1/2	65	28	160	1

■ Impact Reducer



- For machine-operated sockets and adapters
- With square drive as per DIN 3121 - G 12.5 and F 10 / ISO 1174

- Material: Chrome-Molybdenum
- Finish: black phosphated

3/8 **10 mm** **1/2** **12,5 mm**

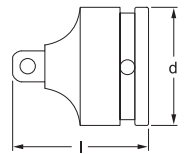

Art. Code	mm	"	mm	"	l mm	d mm	g	
7482 0001	12,5	1/2	10	3/8	38	25	70	1

■ Impact Converter



- For machine-operated sockets and adapters
- With square drive as per DIN 3121 - G 12.5 and F 20 / ISO 1174

- Material: Chrome-Molybdenum
- Finish: black phosphated

3/4 **20 mm** **1/2** **12,5 mm**

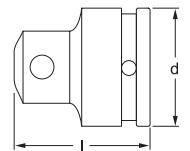

Art. Code	mm	"	mm	"	l mm	d mm	g	
7483 0001	12,5	1/2	20	3/4	48	30	110	1

■ Safety Rings and Safety Pins



- Accident-proof safety system for machine-operated sockets and adapters
- For sockets and accessories with square drive as per DIN 3121 - G 12.5 / ISO 1174

- Resistant to heat, coldness and chemical influences

1/2 **12,5 mm**

Art. Code		mm	"	mm	d mm	d mm	l mm	g	
7499 0001	○	12,5	1/2	10-14	19	3,5		1	10
7499 0002	○	12,5	1/2	15-34	24	3,5		1	10
7499 0101	▭	12,5	1/2	10-14		3,0	20	1	10
7499 0102	▭	12,5	1/2	15-34		3,0	25	1	10

Impact Sockets

- Suitable for all standard electric and air tools
- With square drive as per DIN 3121 - G 20 / ISO 1174
- Suitable for hexagon head screws
- With 6-point profile
- With MATADOR SmartDrive Profile

- Standards: DIN 3129 / ISO 2725-2
- Material: Chrome-Molybdenum
- Finish: black phosphated

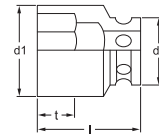

Art. Code	mm	l mm	t mm	d1 mm	d2 mm	g
7575 0170	17	50	7	29	44	310
7575 0180	18	50	7	30	44	320
7575 0190	19	50	9	32	44	325
7575 0220	22	50	14	36	44	345
7575 0240	24	50	14	39	44	350
7575 0270	27	53	14	42	44	370
7575 0300	30	53	15	46	44	410
7575 0320	32	57	15	48	44	450
7575 0330	33	57	18	50	44	480
7575 0340	34	57	18	52	44	490
7575 0360	36	57	18	54	44	520
7575 0380	38	57	18	56	44	540
7575 0410	41	58	22	60	44	610
7575 0460	46	63	24	66	44	710
7575 0500	50	68	30	72	54	850
7575 0550	55	73	30	78	54	1100
7575 0600	60	73	30	84	54	1400
7575 0650	65	85	33	90	54	1700
7575 0700	70	95	35	96	54	1900

Impact Socket Set, 17 pcs.

- Set including the most common impact sockets, short and long type
- With square drive as per DIN 3121 - G 20 / ISO 1174
- Suitable for hexagon head screws
- With 6-point profile
- With MATADOR SmartDrive Profile
- Including compatible safety rings and pins
- With MTS soft foam inlay
- In robust metal case



Art. Code	g
7575 9001	9000
7575 17 - 19 - 22 - 24 - 27 - 30 - 32 mm	
7581 17 - 19 - 22 - 24 - 27 - 30 - 32 - 33 mm	
7599 1x 17-46	
7599 1x 17-46	

METAL

■ Impact Sockets, long type



- Suitable for all standard electric and air tools
- With square drive as per DIN 3121 - G 20 / ISO 1174
- Suitable for hexagon head screws
- With 6-point profile
- With MATADOR SmartDrive Profile
- Standards: DIN 3129 / ISO 2725-2
- Material: Chrome-Molybdenum
- Finish: black phosphated

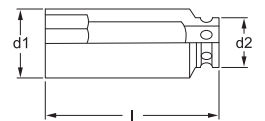

Art. Code	mm	l mm	t mm	d1 mm	d2 mm	g
7581 0170	17	90	12	29	44	500
7581 0180	18	90	12	30	44	530
7581 0190	19	90	12	32	44	550
7581 0220	22	90	19	36	44	590
7581 0240	24	90	19	39	44	610
7581 0270	27	90	19	42	44	640
7581 0300	30	90	19	46	44	700
7581 0320	32	90	19	48	44	730
7581 0330	33	90	19	50	44	780
7581 0340	34	90	19	52	44	810
7581 0360	36	90	19	54	44	850
7581 0380	38	90	19	56	44	880
7581 0410	41	90	56	60	44	960
7581 0460	46	90	56	66	44	1200
7581 0500	50	95	56	72	54	1400

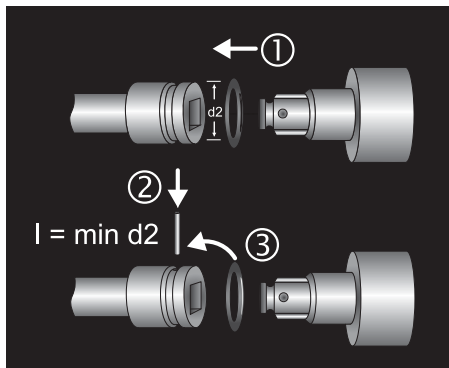

Assignment of impact tools and retaining rings and pins

■ Impact Screwdriver Bit Sockets (TORX®)



- Suitable for all standard electric and air tools
- With square drive as per DIN 3121 - G 20 / ISO 1174
- Suitable for recessed TORX® head screws
- Material: Chrome-Molybdenum
- Finish: black phosphated

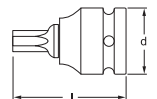

Art. Code	l mm	d mm	g		
7592 0550	T55 M12	100	44	260	1
7592 0600	T60 M14	100	44	330	1
7592 0700	T70 M16	100	44	350	1
7592 0800	T80 M18	100	44	425	1
7592 0900	T90 M20	100	44	460	1
7592 1000	T100 M22	100	44	485	1

Impact Screwdriver Bit Sockets (Hexagon)



- Suitable for all standard electric and air tools
- With square drive as per DIN 3121 - G 20 / ISO 1174
- Suitable for in-hex screws
- With 6-point profile
- With MATADOR SmartDrive Profile
- Standards: DIN 3129 / ISO 2725-2
- Material: Chrome-Molybdenum
- Finish: black phosphated

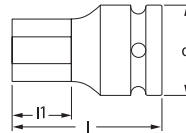

Art. Code	mm	l mm	d mm	g
7578 0100	10	100	44	430
7578 0120	12	100	44	465
7578 0140	14	100	44	480
7578 0170	17	100	44	545
7578 0190	19	100	44	585
7578 0220	22	100	44	640
7578 0240	24	100	44	685
7578 0270	27	100	44	760



Impact Extensions



- For machine-operated sockets and adapters
- With square drive as per DIN 3121 - G 20 and F 20 / ISO 1174
- Material: Chrome-Molybdenum
- Finish: black phosphated

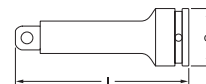

Art. Code	mm	"	mm	"	l mm	l"	d mm	g
7565 0001	20	3/4	20	3/4	150	6	44	700
7565 0002	20	3/4	20	3/4	250	10	44	1060
7565 0003	20	3/4	20	3/4	400	16	44	1600



Impact Universal Joint



- For machine-operated sockets and adapters
- With square drive as per DIN 3121 - G 20 and F 20 / ISO 1174
- Material: Chrome-Molybdenum
- Finish: black phosphated

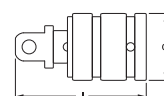

Art. Code	mm	"	mm	"	l mm	d mm	g
7558 0001	20	3/4	20	3/4	90	44	600



■ Impact Reducer

1/2 **12.5** **3/4** **20**
mm mm mm mm



- For machine-operated sockets and adapters
- With square drive as per DIN 3121 - G 20 and F 12.5 / ISO 1174

- Material: Chrome-Molybdenum
- Finish: black phosphated

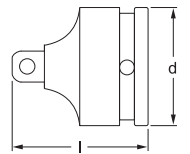

Art. Code	mm	"	mm	"	l mm	d mm	g	
7582 0001	20	3/4	12,5	1/2	58	44	220	1



■ Impact Converter

1 **25** **3/4** **20**
mm mm mm mm



- For machine-operated sockets and adapters
- With square drive as per DIN 3121 - G 20 and F 25 / ISO 1174

- Material: Chrome-Molybdenum
- Finish: black phosphated

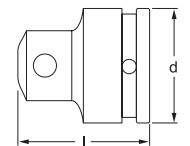

Art. Code	mm	"	mm	"	l mm	d mm	g	
7583 0001	20	3/4	25	1	63	44	450	1

■ Safety Rings and Safety Pins

3/4 **20**
mm mm



- Accident-proof safety system for machine-operated sockets and adapters
- For sockets and accessories with square drive as per DIN 3121 - G 20 / ISO 1174

- Resistant to heat, coldness and chemical influences

Art. Code		mm	"	mm	d mm	d mm	l mm	g	
7599 0001	○	20	3/4	17 - 46	37	5,0		1	10
7599 0002	○	20	3/4	50 - 70	44	5,0		1	10
7599 0101	▭	20	3/4	17 - 46		4,0	35	1	10
7599 0102	▭	20	3/4	50 - 70		4,0	45	1	10



Impact Sockets



- Suitable for all standard electric and air tools
- With square drive as per DIN 3120 - G 25 / ISO 1174
- Suitable for hexagon head screws
- With 6-point profile
- With MATADOR SmartDrive Profile

- Standards: DIN 3129 / ISO 2725-2
- Material: Chrome-Molybdenum
- Finish: black phosphated

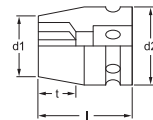

Art. Code	mm	l mm	t mm	d1 mm	d2 mm	g
7675 0190	19	58	12	36	54	510
7675 0220	22	58	12	39	54	530
7675 0240	24	58	14	42	54	560
7675 0270	27	58	14	46	54	580
7675 0300	30	62	16	49	54	610
7675 0320	32	62	19	52	54	660
7675 0330	33	62	19	54	54	710
7675 0340	34	62	19	54	54	710
7675 0360	36	65	19	56	54	720
7675 0380	38	62	20	58	54	740
7675 0410	41	68	23	61	54	800
7675 0460	46	72	23	68	54	1010
7675 0500	50	75	26	74	54	1180
7675 0550	55	83	28	80	54	1480
7675 0600	60	87	31	87	54	1750
7675 0650	65	90	32	92	54	1850
7675 0700	70	93	35	96	54	2500
7675 0750	75	95	40	99	86	2800
7675 0800	80	95	47	112	86	2900
7675 0850	85	95	47	118	86	3200
7675 0900	90	100	47	124	86	3800



Impact Sockets, long type



- Suitable for all standard electric and air tools
 - With square drive as per DIN 3121 - G 25 / ISO 1174
 - Suitable for hexagon head screws
 - With 6-point profile
 - With MATADOR SmartDrive Profile
- Standards: DIN 3129 / ISO 2725-2
 - Material: Chrome-Molybdenum
 - Finish: black phosphated

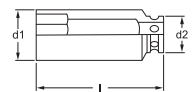

Art. Code	mm	l mm	t mm	d1 mm	d2 mm	g	
7681 0190	19	90	14	36	54	800	5
7681 0220	22	90	16	39	54	800	5
7681 0240	24	90	16	42	54	840	5
7681 0270	27	90	19	46	54	890	5
7681 0300	30	90	19	49	54	930	5
7681 0320	32	90	19	52	54	950	5
7681 0330	33	90	23	54	54	1000	5
7681 0340	34	90	23	54	54	1000	5
7681 0360	36	90	23	56	54	1050	5
7681 0380	38	95	23	58	54	1150	5
7681 0410	41	95	40	61	54	1220	5
7681 0460	46	95	40	68	54	1350	5
7681 0500	50	105	40	74	54	1600	5
7681 0550	55	105	52	80	54	1900	5
7681 0600	60	105	52	87	54	2100	5
7681 0650	65	115	60	92	54	2350	5
7681 0700	70	120	60	97	54	2650	5
7681 0750	75	125	60	104	86	4000	5
7681 0800	80	135	75	112	86	4500	5

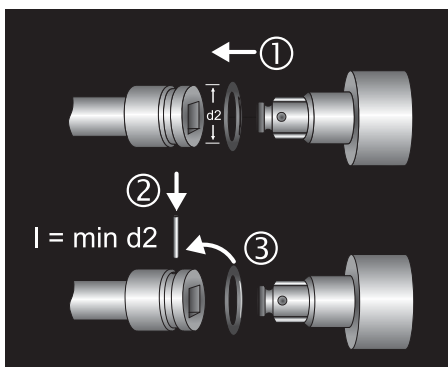

Assignment of impact tools and retaining rings and pins

Impact Extensions



- For machine-operated sockets and adapters
 - With square drive as per DIN 3120 - G 25 / ISO 1174
- Material: Chrome-Molybdenum
 - Finish: black phosphated



Art. Code	mm	"	mm	"	l mm	l "	d mm	g
7665 0001	25	1	25	1	150	6	54	1170
7665 0002	25	1	25	1	330	13	54	2350

Impact Universal Joint

1 25 mm 1 25 mm

- For machine-operated sockets and adapters
- With square drive as per DIN 3120 - G 25 / ISO 1174

- Material: Chrome-Molybdenum
- Finish: black phosphated

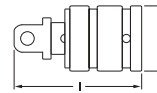

Art. Code	mm	"	mm	"	l mm	d mm	g	
7658 0001	25	1	25	1	140	54	1400	1



Impact Reducer

3/4 20 mm 1 25 mm

- For machine-operated sockets and adapters
- With square drive as per DIN 3121 - G 25 and F 40 / ISO 1174

- Material: Chrome-Molybdenum
- Finish: black phosphated

Art. Code	mm	"	mm	"	l mm	d mm	g	
7682 0001	25	1	20	3/4	77	54	650	1



Impact Converter

1 1/2 40 mm 1 25 mm

- For machine-operated sockets and adapters
- With square drive as per DIN 3121 - G 25 and F 40 / ISO 1174

- Material: Chrome-Molybdenum
- Finish: black phosphated

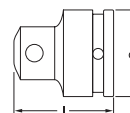

Art. Code	mm	"	mm	"	l mm	d mm	g	
7683 0001	25	1	40	1.1/2	85	54	1000	1



Safety Rings and Safety Pins

1 25 mm

- Accident-proof safety system for machine-operated sockets and adapters
- For sockets and accessories with square drive as per DIN 3121 - G 25 / ISO 1174
- Resistant to heat, coldness and chemical influences

Art. Code	mm	"	mm	d mm	d mm	l mm	g	
7699 0001	○	25	1	19 - 70	44	5,5	1	10
7699 0002	○	25	1	75 - 90	75	5,5	1	10
7699 0101	▭	25	1	19 - 70		5,0	45	10
7699 0102	▭	25	1	75 - 90		5,0	75	10



Pliers.

Be a MATADOR.



Content Pliers.

Page Article group



Heavy Duty Combination Pliers.

141 Heavy Duty Combination Pliers

142 Long Round Nose Plier

142 Long Flat Nose Plier

142 Chain Nose Pliers, straight

142 Chain Nose Pliers, angled 45°



Sidecutters.

143 Side Cutters

143 Heavy Duty Side Cutter



Boldcutters.

144 Lever Bolt Cutter



Pliers for Electrician's.

144 Electrician's Side Cutter „4 in 1“

145 Fully automatic wire stripping plier

145 Wire Stripping Plier

145 Crimping Pliers for Cable Links



Water Pump Pliers.

146 Water Pump Pliers

146 Water Pump Pliers PRO

Page Article group



Pliers Assortments.

147 Pliers Assortment, 3-pieces

147 Pliers Assortment, 4-pieces



Circlip Pliers.

148 Circlip Pliers (A)

148 Circlip Pliers (B)

149 Circlip Pliers (C)

149 Circlip Pliers (D)

149 Assortment Circlip Pliers



Grip Pliers.

150 Universal Grip Pliers

151 Universal Grip Pliers

151 Langbeck Grip Plier



The MATADOR pliers. Simply innovative.



2-component sleeves are more than 2 colors.

Comprehensive research into the gripping characteristics and flow of movement when working with pliers have shown that the use of different materials can considerably relieve the muscles in the hand.

MATADOR 2-component handles thus consist of hard and soft plastic materials making it possible to work without fatigue to a large extent.

The blue, hard component allows a forceful and quick gripping with low friction. The black soft TPE component by contrast has an anti-slip effect and allows powerful working.

Innovative functions in the details:



Integrated ring spanner



Aggressive design



Combination of useful features

Keep it short and simple:
The pliers pictograms.

	Pliers cutting edge tube		Jaw form range
	Pliers cutting edge soft wire		Jaw form range
	Pliers cutting edge medium-hard wire		Jaw form range
	Pliers cutting edge hard wire		Jaw form range
	Pliers cutting edge piano wire		Jaw form range
	Pliers cutting edge round steel		Jaw form mouth wide
	Pliers cutting edge cable		Jaw form mouth length
	Maximum cable cross-section		Jaw form serrated file-cut
	Minimum cable cross-section		Jaw form flat file-cut
	Pliers cutting edge wire rope		Internal retaining ring
	Jaw form		Smallest Ø
	Flat round jaws		Biggest Ø
	Flat jaws		External retaining ring
	Concave jaws		Smallest Ø
	V-shaped jaws		Biggest Ø
	Round jaws		Cutting form
	Jaw form angle		Cutting form with semi bevel
	Pliers cutting edge material thickness		Cutting form with bevel
	Pliers cutting edge engineering steel		Cutting form with center cutting
	Pliers cutting edge stainless steel		Cutting form wire fitting spring
			Ø Tip

Heavy Duty Combination Pliers.

For powerfull grip.

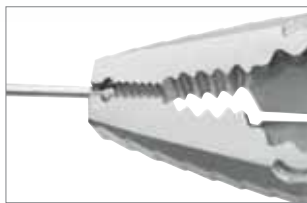

Practical nailholder

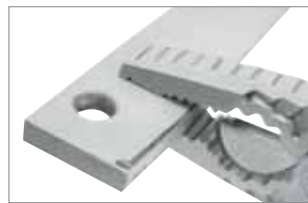

Grip zone for flat and round material



Grip zone for round material



Induction hardened cutting edges for soft, hard and piano-wires

■ Heavy Duty Combination Pliers



- American pattern
 - For cutting hard and soft wires
 - Cutting edges inductively hardened
 - Asymmetric inside jaws for better grip on the workpiece
 - Gripping zones for flat and round materials
 - With Nail- & wire holder
 - Integrated ring spanner
 - Power transmission with optimum leverage for easy and effortless work
 - With ergonomically shaped 2-component sleeves
- Standards: DIN ISO 5746
 - Material: Tool steel
 - Surface: Matt chrome finish

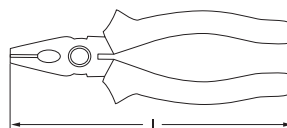

Art. Code	l mm	l"									
					mm	mm	mm	mm	mm	g	
0500 0165	165	6.1/2			4,0	3,1	2,0	10	15	200	6
0500 0180	180	7			5,2	3,4	2,2	12	18	255	6
0500 0205	205	8			5,9	3,8	2,5	13	20	285	6

■ Long Round Nose Pliers

 2K



- For gripping and bending
- Serrated inside jaws
- With long round jaws
- With ergonomically shaped 2-component sleeves
- Standards: DIN ISO 5745

- Material: Tool steel
- Surface: Matt chrome finish

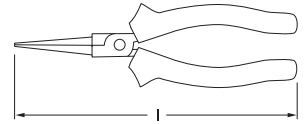

Art. Code	l mm	l "		g	
0520 0160	160	6.1/4		150	6

■ Long Flat Nose Pliers

 2K



- For holding and bending
- Serrated inside jaws
- With long flat jaws
- With ergonomically shaped 2-component sleeves
- Standards: DIN ISO 5745

- Material: Tool steel
- Surface: Matt chrome finish

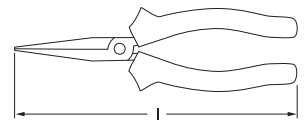

Art. Code	l mm	l "		g	
0525 0160	160	6.1/4		160	6

■ Chain Nose Pliers, straight





 2K

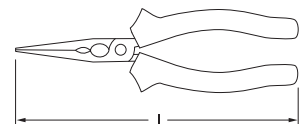

- According to DIN / ISO 5745
- Long, straight flat-round jaws
- With cutting edges and burner hole
- Serrated gripping faces
- For cutting hard and soft wires
- For holding and bending

- Material: High grade tool steel C 45
- Surface: Matt chrome finish



Art. Code	l mm	l "			mm	mm	mm	mm	g	
0585 0170	170	6.3/4			2,5	1,6	-	15	170	6
0585 0205	205	8			3,9	3,2	2,2	18	215	6

■ Chain Nose Pliers, angled 45°

 2K



- According to DIN / ISO 5745
- Long, 45° angled, flat-round jaws
- With cutting edges and burner hole
- Serrated gripping faces
- For cutting hard and soft wires
- For holding and bending

- Material: High grade tool steel C 45
- Surface: Matt chrome finish

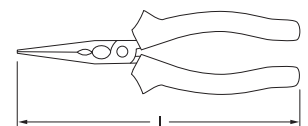

Art. Code	l mm	l "			mm	mm	mm	mm	g	
0586 0205	205	8			3,9	3,2	2,2	18	215	6

Cutting pliers.

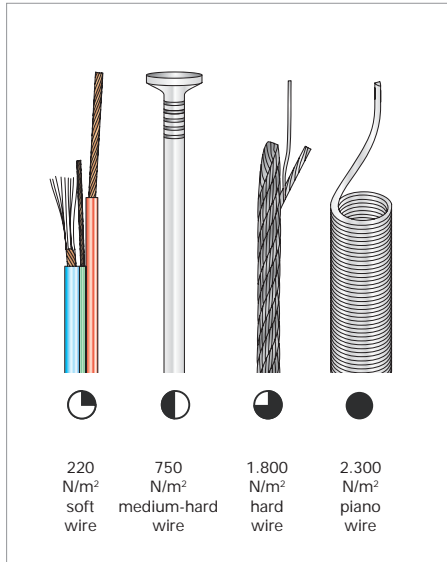

Side Cutters



- For cutting hard and soft wires
- Precision cutting edge for the finest wires
- Cutting edges inductively hardened
- Cutting edge hardness approx 62 HRC
- Power transmission with optimum leverage for easy and effortless work
- With ergonomically shaped 2-component sleeves

- Standards: DIN ISO 5749
- Material: Special tool steel
- Surface: Matt chrome finish

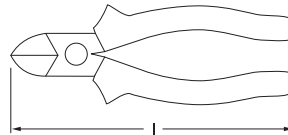

Art. Code	l mm	l"			mm	mm	mm	mm	g
0532 0145	145	5.3/4			5	2,5	1,7	8	180
0532 0160	160	6.1/4			6	3,5	2,0	11	210
0532 0180	180	7			7	4,0	2,5	13	265

Heavy Duty Side Cutters



- Precision cutting edge for piano wire (D2 quality)
- Cutting edges inductively hardened
- Power transmission with optimum leverage for easy and effortless work
- With ergonomically shaped 2-component sleeves

- Standards: DIN ISO 5749
- Material: Special tool steel

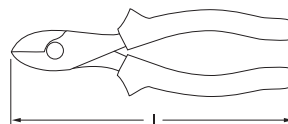

Art. Code	l mm	l"			mm	mm	mm	g
0530 0180	180	7			3,7	2,6	2,2	280
0530 0200	200	8			4,0	2,8	2,5	305
0530 0240	240	9.1/2			4,5	3,5	3,0	420

■ Lever Bolt Cutters



- Forged
- Cutting edges inductively hardened
- With replaceable, screwed cutter head
- Tremendous cutting performance thanks to optimum leverage
- Re-adjustable screw-joint

- Standards: DIN ISO 9242
- Material: Reinforced tube steel / Chrome Vanadium steel

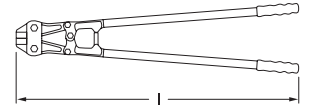

Art. Code	l mm	l "	HRC 10	HRC 40	HRC 44	mm	mm	g
0527 0018	460	18	8	7	5	7	7	1670
0527 0030	780	30	11	9	8	11	9	4570

Art. Code	Spare heads for	g
0527 0011	0527 0018	420
0527 0013	0527 0030	1450



Special pliers for Electrician's and electronics.

■ Electrician's Side Cutter „4 in 1“



- Integrates all 4 functions: cutting - stripping - crimping - bending into one tool
- With ergonomically shaped 2-component sleeves
- With stripping function for single and multi-stranded conductors with 1.5 mm² and 2.5 mm² conductor cross-section
- Precision cutting edge for the finest wires
- Power transmission with optimum leverage for easy and effortless work
- Material: Special tool steel
- Surface: Matt chrome finish

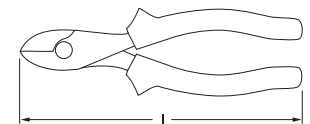

Art. Code	l mm	l "	mm	mm	mm ²	mm	mm	g
0553 0180	190	7.1/2	2,0	1,0	4,0	2,5	1,5	285



Cutting



Stripping



Crimping



Bending

Fully automatic wire stripping pliers

- Wire Stripping Plier with fully automatic adjustment
- Fully insulated
- Integrated side cutting nipper
- In black plastic housing

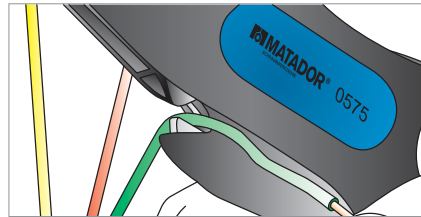

Art. Code	l mm	l"	mm	mm ²	g	
0575 0165	165	6.1/4	⊗	0,2 - 6,0	105	1

Wire Stripping Pliers

- For stripping solid, stranded or finely stranded conductors with standard insulation
- With V-shaped cutting edge for wires and strands up to a max. of Ø 5 mm or 10 mm² conductor cross section
- With adjustable screw for easy adjustment to the required wire or strand diameter
- With opening spring
- With ergonomically shaped 2-component sleeves
- Material: Tool steel

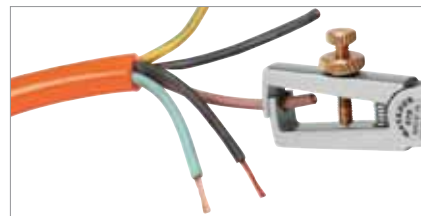

Art. Code	l mm	l"	mm	mm	mm ²	g	
0576 0160	160	6.1/4	⊗	5	10	185	6

Crimping Pliers for Cable Links

- For End-sleeves according to DIN 46228
- Drop-forged
- For non-insulated and insulated endsleeves
- Improved leverage for easier working
- Material: Tool steel, PVC-coated handles

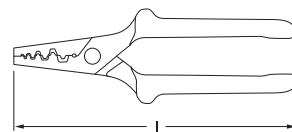

Art. Code	l mm	l"	mm	mm ²	g	
0572 0010	190	7.1/2	⊗	0,5 - 16,0	250	1

Water Pump Pliers.



Box joint.

Finger trap protection for safe work, prevents injuries caused by squeezing.

Double toothed jaws, inductive hardened.

PRO model with automatic precise adjustment.

Water Pump Pliers



- The indestructible water pump pliers, with safety box joint for highest stress
- Gripping capacity 40% above ISO by means of arch-shaped pitch adjustment
- Optimum jaw geometry with self-locking serration
- Cogs additionally induction hardened
- Box joint with wide guide surfaces

- Ideal fulcrum, minimum effort
- Coated handles
- Standards: DIN ISO 8976
- Material: Chrome Vanadium steel

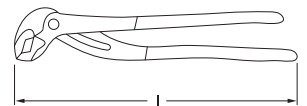

Art. Code	l mm	l"	mm	s	g
0556 0180	180	7	40	1.1/4	155
0556 0240	240	9.1/2	50	2.1/4	350

Water Pump Pliers PRO



- With automatic precise adjustment
- Compact, narrow shape for working in smallest spaces in positions otherwise inaccessible
- With nail and wire holder
- Gripping capacity 40% above ISO by means of arch-shaped pitch adjustment
- Optimum jaw geometry with self-locking serration
- Cogs additionally induction hardened
- Box joint with wide guide surfaces

- Remains locked even after opening the pliers
- Fast adaption of the work piece thanks to innovative ratchet adjustment
- Coated handles
- Standards: DIN ISO 8976
- Material: Chrome Vanadium steel

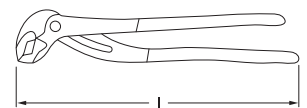

Art. Code	l mm	l"	mm	s	g
0557 0250	250	10	50	2.1/4	360
0557 0320	320	12.1/2	75	3	640
0557 0400	400	15.3/4	100	3.1/2	1255

Pliers Assortment.

Practical and proven sets.

■ Pliers Assortments L

Pliers Assortment, in practical, transparent polypropylene box: robust packaging, stackable and easy to stock, reclosable, reusable and with hanging hole for tools panels

	 
Art. Code	g
0556 9030 	970 1
Content	
 0500 180 mm	
 0530 180 mm	
 0556 240 mm	



2K 

■ Pliers Assortments XL

Pliers Assortment, in practical, transparent polypropylene box: robust packaging, stackable and easy to stock, reclosable, reusable and with hanging hole for tools panels

	 
Art. Code	g
0556 9040 	1270 1
Content	
 0500 180 mm	
 0530 180 mm	
 0585 205 mm	
 0556 240 mm	
0556 9041 	1270 1
Content	
 0500 180 mm	
 0530 180 mm	
 0586 205 mm	
 0556 240 mm	



2K 

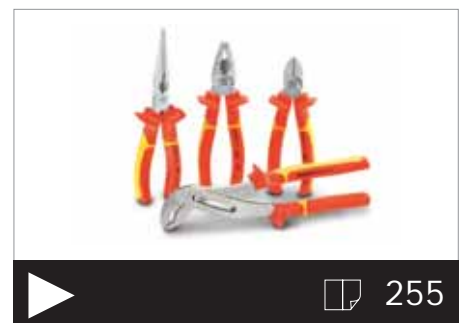
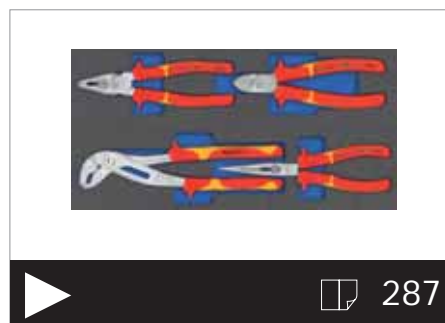
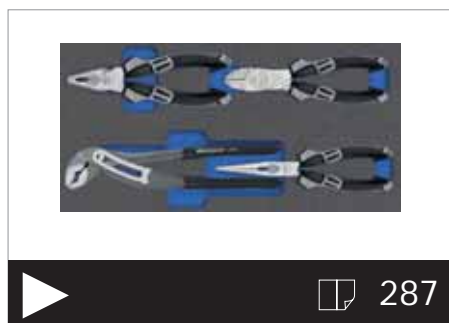

Circlip Pliers.

For assembly from circlips.

Drop-forged precision tips, almost unbreakable, anti-slip.



Ø 3 - 140 mm

■ Circlip Pliers (A)



- For fitting external circlips on shafts according to DIN 471 and DIN 983
- Forged
- With straight jaws and opening spring
- Anti-slip, twisted precision tips
- Coated handles

- Standards: DIN ISO 5254-A
- Material: Chrome Vanadium steel

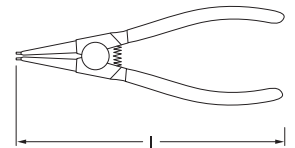

Art. Code	Size	Size		mm		Ø mm	g	
		l mm	l"	mm	mm			
0578 0000	A0	135	5.1/4	3	10	0.9	100	6
0578 0010	A1	135	5.1/4	10	25	1.3	100	6
0578 0020	A2	180	7	19	60	1.8	150	6
0578 0030	A3	220	8.3/4	40	100	2.3	250	6
0578 0040	A4	310	12.1/4	85	140	3.2	500	6

■ Circlip Pliers (B)



- For fitting external circlips on shafts according to DIN 471 and DIN 983
- Forged
- With 90° angled jaws and opening spring
- Anti-slip, twisted precision tips
- Coated handles

- Standards: DIN ISO 5254-B
- Material: Chrome Vanadium steel

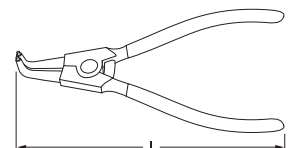

Art. Code	Size	Size		mm		Ø mm	g	
		l mm	l"	mm	mm			
0580 0000	A01	125	5	3	10	0.9	100	6
0580 0110	A11	125	5	10	25	1.3	100	6
0580 0210	A21	165	6.1/2	19	60	1.8	150	6
0580 0310	A31	200	7.3/4	40	100	2.3	250	6
0580 0410	A41	290	11.1/2	85	140	3.2	500	6

■ Circlip Pliers (C)

- For fitting internal circlips in holes according to DIN 472 and DIN 984
- Forged
- With straight jaws
- Anti-slip, twisted precision tips
- Coated handles

- Standards: DIN ISO 5254-C
- Material: Chrome Vanadium steel

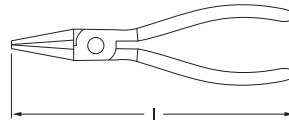

Art. Code	Size	Size		mm		Ø mm	g	
		l mm	l"	mm	mm	mm	g	mm
0582 0010	J1	135	5.1/4	12	25	1,3	100	6
0582 0020	J2	180	7	19	60	1,8	150	6
0582 0030	J3	220	8.3/4	40	100	2,3	250	6
0582 0040	J4	310	12.1/4	85	140	3,2	440	6



■ Circlip Pliers (D)

- For fitting internal circlips in holes according to DIN 472 and DIN 984
- Forged
- With 90° angled jaws and opening spring
- Anti-slip, twisted precision tips
- Coated handles

- Standards: DIN ISO 5254-D
- Material: Chrome Vanadium steel

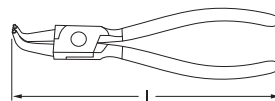

Art. Code	Size	Size		mm		Ø mm	g	
		l mm	l"	mm	mm	mm	g	mm
0584 0110	J11	125	5	12	25	1,3	100	6
0584 0210	J21	165	6.1/2	19	60	1,8	150	6
0584 0310	J31	200	7.3/4	40	100	2,3	250	6
0584 0410	J41	290	11.1/2	85	140	3,2	440	6



■ Circlip Pliers Assortment

Set in practical, transparent polypropylene box: robust packaging, stackable and easy to stock, reclosable, reusable and with hanging hole for tools panels

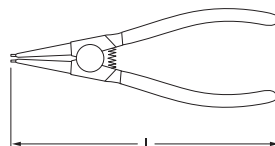

Art. Code	g	mm	mm
0578 9040	600	180	165

Content

- 0578 180 mm A2
- 0580 165 mm A21
- 0582 180 mm J2
- 0584 165 mm J21



Grip Pliers.

For secure gripping, clamping and holding.



■ Universal Grip Pliers

- For securely holding, clamping and tensioning round, profile and/or flat material
- With wire cutter
- High clamping pressure due to toggle lever transmission
- Usable with one hand
- With quick-release and adjusting screw

- Material: CV spring steel
- Surface: Nickel plated

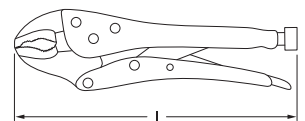

Art. Code	Length		Jaw Width				Weight (g)
	mm	"	mm	mm	mm	mm	
0588 0175	175	7	30	20	30	35	5
0588 0250	250	10	40	20	30	50	5
0588 0300	300	12	65	30	34	65	5

■ Universal Grip Pliers

- With longwise groove in the top jaw
 - Suitable for round and flat materials
 - With wire cutter
 - High clamping pressure due to toggle lever transmission
 - Usable with one hand
 - With quick-release lever and adjusting screw
- Material: CV spring steel
 - Surface: Nickel plated

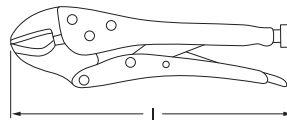

Art. Code	l mm	l"	mm	mm	mm	mm	g	
0588 1180	180	7.1/4	35	25	32	25	400	1
0588 1250	250	10	35	30	32	45	600	1

■ Langbeck Grip Pliers

- For narrow spaces
 - With long, thin jaws
 - With wire cutter
 - High clamping pressure due to toggle lever transmission
 - Usable with one hand
 - With quick-release lever and adjusting screw
- Material: CV spring steel
 - Surface: Nickel plated

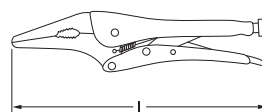

Art. Code	l mm	l"	mm	mm	mm	mm	g	
0589 0165	165	6.1/2	20	10	24	0 - 55	300	1

L-Keys / Screwdrivers.

Be a MATADOR.



Content Screwdriver.

Page Article group



L-Key Wrenches.

155	L-Key Wrenches (Hexagon)
156	L-Key Wrenches set (Hexagon), Minis
156	L-Key Wrenches set (Hexagon), on ring
156	L-Key Wrenches set (Hexagon), in slide box
157	L-Key Wrenches set (Hexagon), in metal holder
158	L-Key Wrenches set (Hexagon), in holder
159	L-Key Wrenches (Hexagon), long type
159	L-Key Wrenches (Hexagon), long type, Minis
160	L-Key Wrenches (Hexagon), long type, in holder
161	L-Key Wrenches (Hexagon), long, ball point head
162	L-Key Wrenches set (hexagon), long, ball point head, in holder
163	L-Key Wrenches (TORX®), in slide box
163	L-Key Wrenches (TORX®), in holder
163	L-Key Wrenches (TORX®), ball point head, in holder
164	2C-T-grip-L-Key Wrenches (Hexagon)
165	2C-T-grip-L-Key Wrenches set (Hexagon)
165	2C-T-grip-L-Key Wrenches (TORX®)
165	2C-T-grip-L-Key Wrenches set (TORX®)



2C-Screwdriver.

167	2C-Screwdriver (Slot)
168	2C-Screwdriver (PH)
168	2C-Screwdriver (PZ)
169	2C-Screwdriver (TORX®)
169	Offset Screwdrivers
169	Screwdriver, short (Slot)
169	Screwdriver, short (PH)



Screwdriver with striking cap.

170	Screwdrivers with wooden handle (Slot)
171	Screwdrivers with wooden handle (Cross recess PH)

Page Article group



Screwdriver sets.

172	2C-Screwdriver set L
172	2C-Screwdriver set XL
173	2C-Screwdriver set (TORX®)
173	Wooden handle Screwdriver set



2C-Precision screwdriver.

174	2C-Precision screwdriver (Slot)
174	2C-Precision screwdriver (PH)
175	2C-Precision screwdriver (TORX®)
175	2C-Precision screwdriver set
175	2C-Precision screwdriver set (TORX®)



Impact Screwdriver and Bits.

176	Mini Screwdriver 4in1
176	Reversible Screwdriver
177	Hand Impact Screwdriver Set
178	Hex Power Shank
178	Hex Power Shank
178	Hex Power Shank
178	Bitholder



Bitbox Torsion.

179	Bit Assortment Torsion
-----	------------------------



Classic L-Key Wrenches for quick mounting.

Short or long pattern. With or without ballpoint. Single keys or key sets.



The screwdrivers for socket head screws.

Socket head screws with hexagon socket or TORX[®] profile belong to the most used screw connections in special engineering and furniture industry.



The fitting L-Key Wrenches are reasonably priced and compact in their dimensions and must not be missing in any tools set. Due to the fact that nothing is more nerve-stretching than the search for a single allen key in a tool box, practical assortments have established:

Single key or key set. It's your choice.

The ring for short type L-Key Wrenches holds the keys together but single keys can easily be taken out.

Besides the clear tool arrangement the metal holder has the advantage that different working positions are possible and that the lever can be prolonged for increased force action.

In the classic slide box the allen key are arranged clearly and stored practically dust-free.

Completely new is the MATADOR softGRIP holder: Its soft material makes it possible to quickly take out the required size. Thanks to its ergonomic design the holder is also perfectly suitable for quick action as the keys can also be used without being taken out.

Professional quality for enduring success.

Even though L-Key Wrenches are relatively simple tools there are some critical quality features that determine the lifetime and service-ability of the keys:

Since many years MATADOR uses a special Chrome Vanadium alloy for L-Key Wrenches in order to realize higher tightening or loosening torques.

Fully automatic CNC machines guarantee tight tolerances and go easy on the screw head. All edges are chamfered so that the L-Key Wrenches can more easily be inserted into the screw head. This is especially advantageous in case of worn out screws.

Proven production technologie.

The L-Key Wrenches are Fully hardened and instead of a simple laser marking they are provided with a durable stamping from the size of 3 mm.

The final full-galvanic treatment during which the L-Key Wrenches are nickel-plated and chrome-plated ensures a long-lasting corrosion protection.



Chamfered edges for easy inserting into the screw head

L-Key Wrenches (Hexagon)

- L-Key Wrenches for inside hexagon socket screws, short type
- Fully hardened
- Standards: Similar to ISO 2936 (DIN 911)
- Material: Chrome Vanadium

- Surface: Matt chrome finish

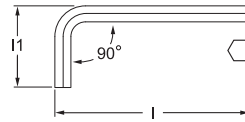

Art. Code	mm	l mm	l1 mm	g	
0440 0020	2,0	50	16	2	10
0440 0025	2,5	57	19	3	10
0440 0030	3,0	64	21	5	10
0440 0035	3,5	68	24	7	10
0440 0040	4,0	72	27	10	10
0440 0045	4,5	78	29	14	10
0440 0050	5,0	83	31	18	10
0440 0055	5,5	89	34	24	10
0440 0060	6,0	94	36	30	10
0440 0070	7,0	100	39	43	10
0440 0080	8,0	105	42	60	10
0440 0090	9,0	112	45	81	10
0440 0100	10,0	120	48	105	10
0440 0110	11,0	125	51	150	10
0440 0120	12,0	133	55	170	5
0440 0140	14,0	152	68	265	5
0440 0170	17,0	174	78	442	5
0440 0190	19,0	195	87	631	5
0440 0220	22,0	216	100	920	5
0440 0240	24,0	242	112	1238	5
0440 0270	27,0	272	125	1740	5
0440 0300	30,0	310	140	2410	5
0440 0320	32,0	342	155	3080	5



Overview MATADOR- L-Key-Wrenches:

0440			
0441			
0442			
0443			
0444			
0445			
0446			

■ L-Key Wrenches set (Hexagon), Minis



- L-Key Wrenches for inside hexagon socket screws, short type
- Attractive Mini sets with the most important sizes
- With plastic hanger and EAN label
- Fully hardened

- Standards: Similar to ISO 2936 (DIN 911)
- Material: Chrome Vanadium
- Surface: Matt chrome finish

Art. Code			g	
0440 9040	4	0440	1.5 - 2.0 - 2.5 - 3.0 mm	25 1
0440 9030	3	0440	4.0 - 5.0 - 6.0 mm	75 1
0440 9020	2	0440	8.0 - 10.0 mm	175 1

■ L-Key Wrenches set (Hexagon), on ring



- L-Key Wrenches for inside hexagon socket screws, short type
- Sets in practical ring holder
- Individually removable
- Packaging with butterfly hole and EAN label
- Fully hardened

- Standards: Similar to ISO 2936 (DIN 911)
- Material: Chrome Vanadium
- Surface: Matt chrome finish

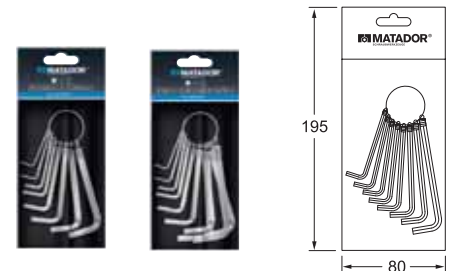

Art. Code			g	
0440 9080	8	0440	1.5 - 2.0 - 2.5 - 3.0 - 4.0 - 5.0 - 5.5 - 6.0 mm	115 1
0440 9100	10	0440	2.0 - 2.5 - 3.0 - 4.0 - 4.5 - 5.0 - 5.5 - 6.0 - 8.0 - 10.0 mm	270 1

■ L-Key Wrenches set (Hexagon), in slide box



- L-Key Wrenches for inside hexagon socket screws, short type
- Set in robust plastic slide box
- Clearly arranged for quick removal
- With butterfly hole and EAN label
- Fully hardened

- Standards: Similar to ISO 2936 (DIN 911)
- Material: Chrome Vanadium
- Surface: Matt chrome finish

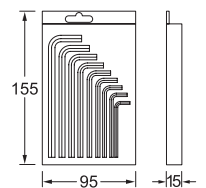

Art. Code			g	
0440 9090	9	0440	1.5 - 2.0 - 2.5 - 3.0 - 4.0 - 5.0 - 6.0 - 8.0 - 10.0 mm	275 1

L-Key Wrenches in metal holder.

Rattle-free storage with big leverage effect.



■ L-Key Wrenches set (Hexagon), in metal holder



- L-Key Wrenches for inside hexagon socket screws, short type
- Standards: Similar to ISO 2936 (DIN 911)
- Set in practical metal holder
- Material: Chrome Vanadium
- Packaging with butterfly hole and EAN label
- Surface: Matt chrome finish
- Fully hardened



Art. Code	g	
0440 9070	410	1
0440 2.0 - 3.0 - 4.0 - 5.0 - 6.0 - 8.0 - 10.0 mm		

The new softGRIP holder.

Proper storage and quick removal.

softGRIP

Especially soft and flexible TPE material for quick and easy removal of the L-Key Wrenches.

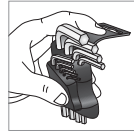

Clear, durable marking of the single L-Key Wrenches.

Integrated hanger for workshop panels etc.



Ergonomic, spherical design with rounded edges for comfortable hold or direct working without removal of the single keys.



■ L-Key Wrenches set (Hexagon), in holder



- L-Key Wrenches for inside hexagon socket screws, short type
- Set in black softGRIP holder
- With hanger and EAN label
- Fully hardened

- Standards: Similar to ISO 2936 (DIN 911)
- Material: Chrome Vanadium
- Surface: Matt chrome finish

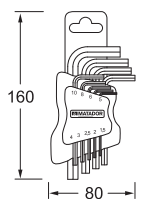

Art. Code

softGRIP

0440 9091 0440 1.5 - 2.0 - 2.5 - 3.0 - 4.0 - 5.0 - 6.0 - 8.0 - 10.0 mm



g

295

1

■ L-Key Wrenches (Hexagon), long type

- L-Key Wrenches for inside hexagon socket screws, long type
- Fully hardened
- Standards: Similar to ISO 2936 (DIN 911)
- Material: Chrome Vanadium
- Surface: Matt chrome finish

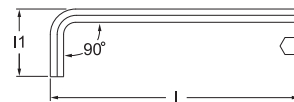

Art. Code	mm	l mm	l1 mm	g	
0441 0020	2,0	100	16	4	10
0441 0025	2,5	112	19	5	10
0441 0030	3,0	127	21	5	10
0441 0040	4,0	142	27	8	10
0441 0050	5,0	163	31	30	10
0441 0060	6,0	184	36	50	10
0441 0080	8,0	206	42	100	10
0441 0100	10,0	232	48	180	10
0441 0120	12,0	258	61	280	5
0441 0140	14,0	290	68	450	5
0441 0170	17,0	333	78	750	5
0441 0190	19,0	375	87	1275	5

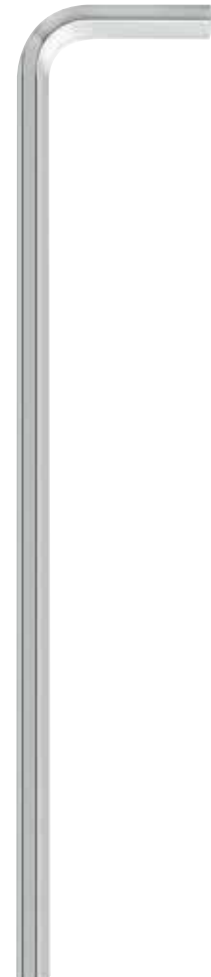

■ L-Key Wrenches (Hexagon), long type, Minis

- L-Key Wrenches for inside hexagon socket screws, long type
- Attractive Mini sets with the most important sizes
- With plastic hanger and EAN label
- Fully hardened
- Standards: Similar to ISO 2936 (DIN 911)
- Material: Chrome Vanadium
- Surface: Matt chrome finish

Art. Code		g	
0441 9031	3 0441 2.0 - 2.5 - 3.0 mm	30	1
0441 9030	3 0441 4.0 - 5.0 - 6.0 mm	115	1
0441 9020	2 0441 8.0 - 10.0 mm	295	1

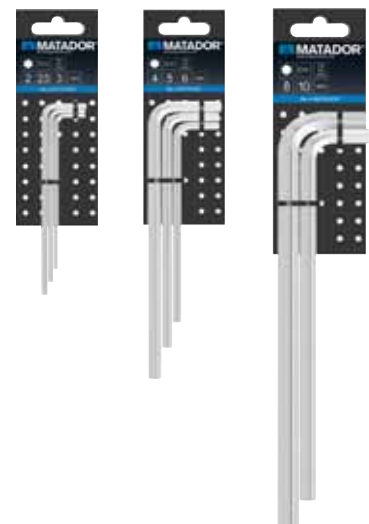

■ L-Key Wrenches (Hexagon), long type, in holder



- L-Key Wrenches for inside hexagon socket screws, long type
- Set in black softGRIP-holder
- With plastic hanger and EAN label
- Fully hardened

- Standards: Similar ISO 2936 (DIN 911)
- Material: Chrome Vanadium
- Surface: Matt chrome finish

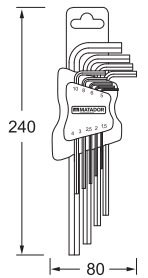

Art. Code

softGRIP

0441 9091   0441 1.5 - 2.0 - 2.5 - 3.0 - 4.0 - 5.0 - 6.0 - 8.0 - 10.0 mm



g

295

1

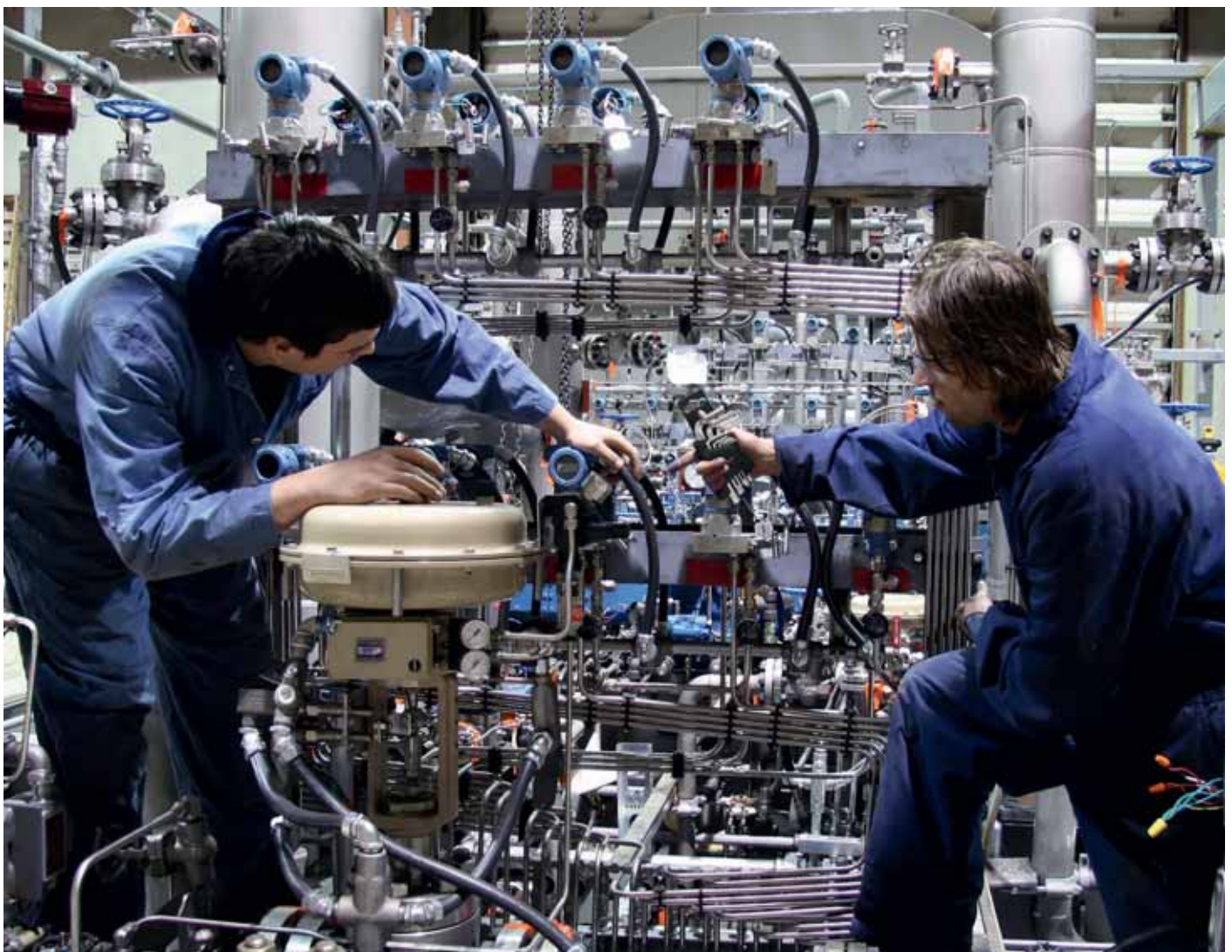

■ L-Key Wrenches (Hexagon), long, ball point head



- L-Key Wrenches for inside hexagon socket screws, long type
- With ball point head on the long end, use in awkward areas, swivel angle up to 25°
- Fully hardened
- Standards: Similar ISO 2936 (DIN 911)
- Material: Chrome Vanadium
- Surface: Matt chrome finish

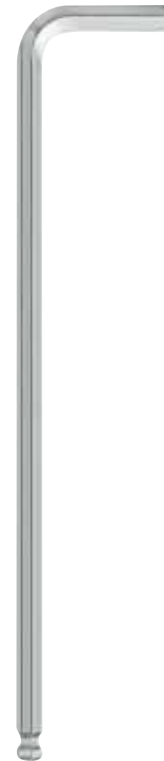

Art. Code	mm	l mm	l1 mm	g	
0442 0015	1.5	90	15	3	10
0442 0020	2.0	100	16	4	10
0442 0025	2.5	112	19	5	10
0442 0030	3.0	127	21	5	10
0442 0040	4.0	142	27	8	10
0442 0050	5.0	163	31	30	10
0442 0060	6.0	184	36	50	10
0442 0080	8.0	206	42	100	10
0442 0100	10.0	232	48	180	5
0442 0120	12.0	258	61	280	5
0442 0140	14.0	290	68	450	5
0442 0170	17.0	333	78	750	5
0442 0190	19.0	375	87	1275	5

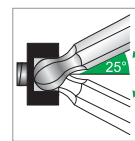

Art. Code	* AF	l mm	l1 mm	g	
0442 8001	1/16	90	14	2	10
0442 8002	5/64	100	16	3	10
0442 8003	3/32	112	19	5	10
0442 8004	1/8	127	21	8	10
0442 8005	5/32	142	27	15	10
0442 8006	3/16	163	31	21	10
0442 8007	7/32	170	34	31	10
0442 8008	1/4	184	36	51	10
0442 8009	5/16	206	42	78	10
0442 8010	3/8	232	48	154	5
0442 8012	1/2	258	61	190	5





■ L-Key Wrenches set (hexagon), long, ball point head, in holder



- L-Key Wrenches for inside hexagon socket screws, long type
 - With ball point head on the long end, use in awkward areas, swivel angle up to 25°
 - Set in black softGRIP-holder
 - With plastic hanger and EAN label
 - Fully hardened
- Standards: Similar ISO 2936 (DIN 911)
 - Material: Chrome Vanadium
 - Surface: Matt chrome finish

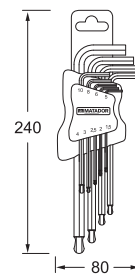

Art. Code	g	
0442 9091	400	1
0442 1,5 - 2,0 - 2,5 - 3,0 - 4,0 - 5,0 - 6,0 - 8,0 - 10,0 mm		

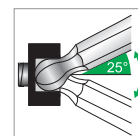

softGRIP

■ L-Key Wrenches (TORX®), in slide box



- Key Wrenches, for inside TORX® screws, short type
- Permanent arrangement und quick removal
- Set in solid plastic box with slide cover
- With plastic hanger and EAN label
- Fully hardened

- Material: Chrome Vanadium
- Surface: Black phosphated

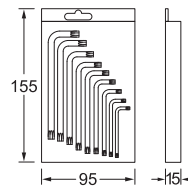

Art. Code		g	
0443 9090	0443 T10 - T15 - T20 - T25 - T27 - T30 - T40 - T45 - T50	275	1

■ L-Key Wrenches (TORX®), in holder



- Key Wrenches, for inside TORX® screws, short type
- Set in black softGRIP-holder
- With plastic hanger and EAN label
- Fully hardened

- Material: Chrome Vanadium
- Surface: Matt chrome finish

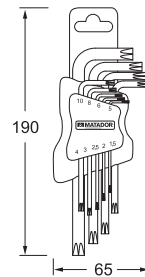

Art. Code		g	
0443 9091	0443 T10 - T15 - T20 - T25 - T27 - T30 - T40 - T45 - T50	300	1

■ L-Key Wrenches (TORX®), ball point head, in holder



- Key Wrenches, for inside TORX® screws, short type
- With ball point head on the long end, use in awkward areas, swivel angle up to 25°
- Set in black softGRIP-holder
- With plastic hanger and EAN label
- Fully hardened

- Material: Chrome Vanadium
- Surface: Matt chrome finish

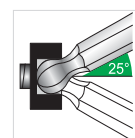
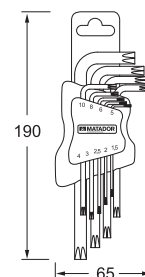

Art. Code		g	
0444 9090	0444 T10 - T15 - T20 - T25 - T27 - T30 - T40 - T45 - T50	300	1

Powerful tightening with the MATADOR 2C T-Handle.

For special requirements.

For special requirements.

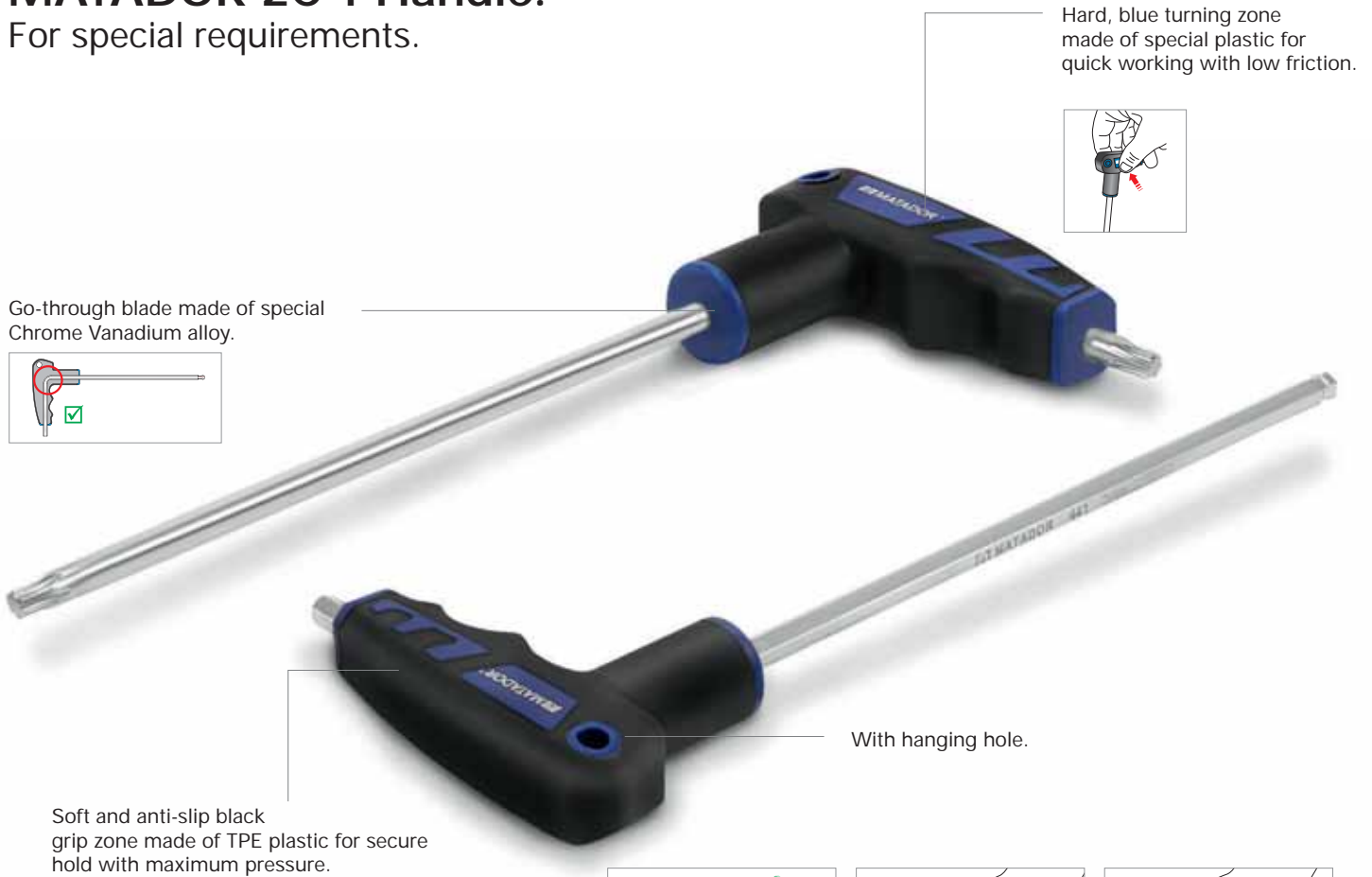

Go-through blade made of special Chrome Vanadium alloy.

Hard, blue turning zone made of special plastic for quick working with low friction.

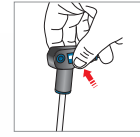
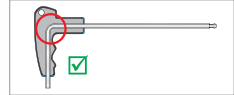

With hanging hole.

Soft and anti-slip black grip zone made of TPE plastic for secure hold with maximum pressure.

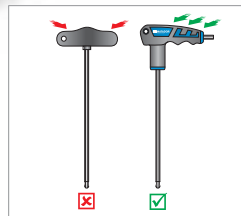

Asymmetric wings for high torque transmission

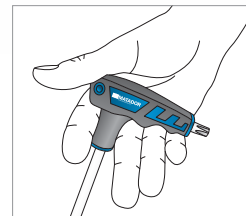

Especially ergonomic design

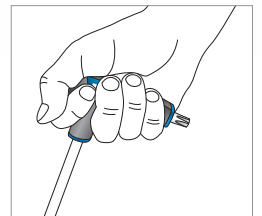

Comfortable hold thanks to exactly formed grips

2C-T-grip-L-Key Wrenches (Hexagon)

2K



- T-grip-L-Key Wrenches for inside hexagon screws, long type
- With ball point head on the long end, use in awkward areas, swivel angle up to 25°
- Fully hardened
- With 2 component handle with hard turning zone and soft grip zone With hanging hole

- Material: Chrome Vanadium
- Surface: Matt chrome finish

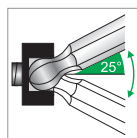
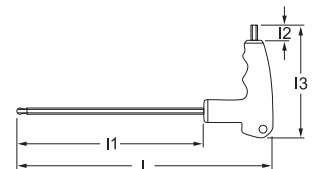



Art. Code	mm	l mm	l1 mm	l2 mm	l3 mm	g
0445 0020	2.0	138	100	9	65	18
0445 0030	3.0	138	100	9	65	24
0445 0040	4.0	196	150	10	78	48
0445 0050	5.0	196	150	10	78	63
0445 0060	6.0	256	200	15	97	91
0445 0080	8.0	256	200	15	97	170
0445 0100	10.0	256	200	15	97	242

2C-T-grip-L-Key Wrenches set (Hexagon)

2K  

- Set of Key Wrenches 2C-T-grip-L-Key wrenches for inside hexagon screws, long type, 7-pcs
- The most important sizes in one set
- Set in practical roll bag made of black artificial leather, with strap fastener and 10 compartments (size: 460 x 320 mm)



		
Art. Code	g	
0445 9070    0445 2 - 3 - 4 - 5 - 6 - 8 - 10 mm	800	1

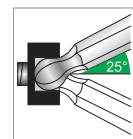





2C-T-grip-L-Key Wrenches (TORX®)

2K 

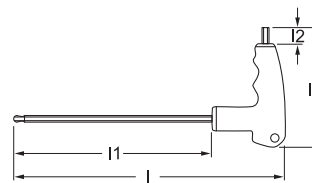
- T-grip-L-Key Wrenches for inside TORX® screws, long type
- Blade fully hardened
- With 2 component handle with hard turning zone and soft grip zone With hanging hole
- With hanging hole

- Material: Chrome Vanadium
- Surface: Matt chrome finish









							
Art. Code		l mm	l1 mm	l2 mm	l3 mm	g	
0446 0100 T10		138	100	12	68	24	10
0446 0150 T15		138	100	12	68	24	10
0446 0200 T20		138	100	12	68	31	10
0446 0250 T25		145	100	15	83	48	10
0446 0270 T27		145	100	15	83	53	10
0446 0300 T30		207	150	15	97	100	10
0446 0400 T40		207	150	15	97	120	10
0446 0450 T45		207	150	15	97	140	10
0446 0500 T50		207	150	15	97	180	10

2C-T-grip-L-Key Wrenches set (TORX®)

2K  

- Set of Key Wrenches 2C-T-grip-L-Key wrenches for inside hexagon screws, long type, 9-pcs
- The most important sizes in one set
- Set in practical roll bag made of black artificial leather, with strap fastener and 10 compartments (size: 460 x 320 mm)



		
Art. Code	g	
0446 9090    0446 T10 - T15 - T20 - T25 - T27 - T30 - T40 - T45 - T50	830	1

MATADOR 2-Component Screwdrivers. Spare the hand for powerful screwing. Especially ergonomic design for effortless working.



Burnished tip for precise, durable fitting into the screw.

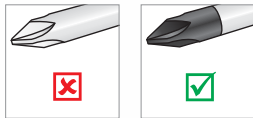

Soft and anti-slip grey grip zone made of TPE plastic for secure hold with maximum pressure.

Hard, black turning zone made of special plastic for quick working with low friction.

With spheric handle end for comfortable support when high torques are applied.

Protection from slipping and rolling away through hex design.

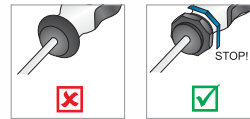

Chrome-plated blades made of high-alloyed special steel for optimal corrosion protection.



2-component handles are more than 2 colors.

Comprehensive research into the gripping characteristics and flow of movement when working with screwdrivers have shown that the use of different materials can considerably relieve the muscles in the hand.

MATADOR 2-component handles thus consist of hard and soft plastic materials making it possible to work without fatigue to a large extend.

The special plastic material of the black movement component offers a variety of advantages: It is highly impact-resistant, splinterproof, insulating, resistant to oil and solvents, heat-resistant and flame-resistant. Moreover it has a low weight and is suitable for use within a wide temperature range (-35°C up to +70°C).

For quick and forceful tightening.

The hard component allows a forceful and quick tightening with low friction. Thanks to the bigger diameter of the hard component the screwdriver can be turned in the hand like a wheel.

The soft TPE component by contrast has an anti-slip effect and allows powerful working.

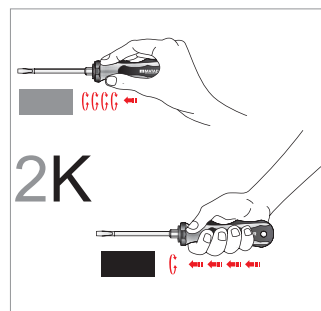

Clear marking and practical details.

All MATADOR 2C screwdrivers have an additional identification of the tool profile at the handle end, so that the required screwdriver can quickly be found in the tool box.

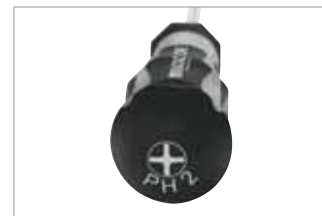

The borehole at the handle end allows the insertion of a sliding bar for loosening seized screws or can be used as hanging hole to improve tool order at the tools panel.

The shape follows the human hand.



The spheric shape of the MATADOR 2-component handles has been designed in such a way that the human hand can encompass the handle optimally.

With that the hand's force is spread over a maximum contact surface so that pressure points can be avoided and an optimal transfer of forces is ensured.

Ergonomics you can touch!

2C-Screwdriver (Slot)

- Premium workshop screwdrivers with shovelshaped tip
- With hexagon blade for torque increase together with a spanner
- With 2-component handle with hard turning zone and soft grip zone
- With burnished tip

- With hanging hole
- Standards: DIN ISO 2380-2 / tip to DIN ISO 2380-1 Form A

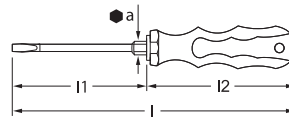

Art. Code	mm	mm	a mm	l mm	l1 mm	l2 mm	g	
0605 1055	1,0	5,5	8	205	100	105	73	10
0605 1265	1,2	6,5	10	230	125	105	92	10
0605 1280	1,2	8,0	13	270	150	120	164	10
0605 1610	1,6	10,0	13	295	175	120	179	10
0605 2012	2,0	12,0	16	320	200	120	255	5
0605 2514	2,5	14,0	16	370	250	120	330	5



2K

2C-Screwdriver (Slot)

- Classic workshop screwdrivers with shovelshaped tip
- With 2-component handle with hard turning zone and soft grip zone
- With burnished tip
- With hanging hole

- Standards: DIN ISO 2380-2 / tip to DIN ISO 2380-1 Form A

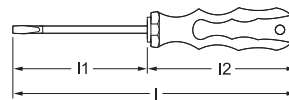

Art. Code	mm	mm	l mm	l1 mm	l2 mm	g	
0615 0640	0,6	4,0	160	75	85	40	10
0615 0850	0,8	5,0	195	100	95	55	10
0615 1055	1,0	5,5	230	125	105	70	10
0615 1265	1,2	6,5	255	150	105	85	10
0615 1280	1,2	8,0	295	175	120	128	5
0615 1610	1,6	10,0	370	250	120	166	5

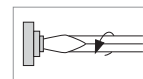

2K

Precision Screwdrivers (slotted)

- Screwdrivers for electronics engineers with plane parallel tip
- With 2-component handle with hard turning zone and soft grip zone
- With burnished tip
- With hanging hole

- Standards: DIN ISO 2380-2 / tip to DIN ISO 2380-1 Form B

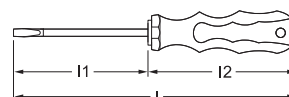

Art. Code	mm	mm	l mm	l1 mm	l2 mm	g	
0660 0425	0,4	2,5	160	75	85	33	10
0660 0530	0,5	3,0	185	100	85	35	10
0660 0840	0,8	4,0	195	100	95	50	10
0660 0850	0,8	5,0	245	150	95	81	5

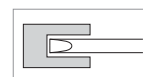

2K

2C-Screwdriver (PH)

2K 



- Premium screwdriver for Cross head screws Phillips-Recess
- With hexagon blade for torque increase together with a spanner
- With 2-component handle with hard turning zone and soft grip zone
- With black phosphated tip
- With hanging hole

- Standards: DIN ISO 8764 / tip to DIN ISO 8764-1 PH
- Material Blade: Chrome Vanadium
- Surface Blade: Matt chrome finished

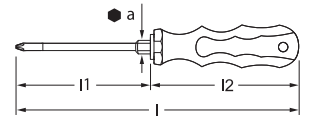

Art. Code		a mm	l mm	l1 mm	l2 mm	g
0658 0010	PH 1	8	175	80	95	55
0658 0020	PH 2	10	205	100	105	84
0658 0030	PH 3	13	270	150	120	158
0658 0040	PH 4	16	320	200	120	248

2C-Screwdriver (PH)

2K 



- Classical screwdriver for Cross head screws Phillips-Recess
- With 2-component handle with hard turning zone and soft grip zone
- With black phosphated tip
- With hanging hole

- Standards: DIN ISO 8764 / tip to DIN ISO 8764-1 PH
- Material Blade: Chrome Vanadium
- Surface Blade: Matt chrome finished

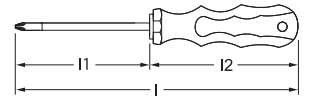

Art. Code		l mm	l1 mm	l2 mm	g
0655 0000	PH 0	175	80	95	34
0655 0010	PH 1	175	80	95	34
0655 0020	PH 2	205	100	105	77
0655 0030	PH 3	270	150	120	145

2C-Screwdriver (PZ)

2K 



- Classical screwdriver for Pozidriv screws
- With 2-component handle with hard turning zone and soft grip zone
- With black phosphated tip
- With hanging hole

- Standards: DIN ISO 8764 / tip to DIN ISO 8764-1 PZ
- Material Blade: Chrome Vanadium
- Surface Blade: Matt chrome finished

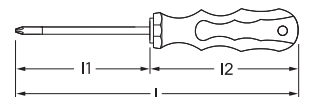

Art. Code		l mm	l1 mm	l2 mm	g
0657 0000	PZ 0	175	80	95	34
0657 0010	PZ 1	175	80	95	34
0657 0020	PZ 2	205	100	105	77
0657 0030	PZ 3	270	150	120	145

2C-Screwdriver (TORX®)

2K 

- Workshop screwdriver for inside TORX® screws
- With 2-component handle with hard turning zone and soft grip zone
- With black phosphated tip
- With hanging hole

- Material Blade: Chrome Vanadium
- Surface Blade: Matt chrome finished

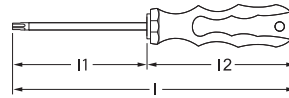

Art. Code	l mm	l1 mm	l2 mm	g
0620 0100 T10	175	80	95	37
0620 0150 T15	175	80	95	40
0620 0200 T20	195	100	95	44
0620 0250 T25	195	100	95	48
0620 0270 T27	220	115	105	71
0620 0300 T30	220	115	105	85
0620 0400 T40	250	130	120	125



Offset Screwdrivers

- For working in places with difficult access

- Material: Chrome Vanadium
- Surface: nickel plated

Art. Code	mm	mm	l mm	g
0627 0640	0.6	4.0	100	9
0627 1055	1.0	5.5	125	22
0627 1280	1.2	8.0	150	55
0628 1020	PH 1 - PH 2		100	23
0628 3040	PH 3 - PH 4		150	70



Screwdriver, short (Slot)

- For working in places with difficult access
- With black phosphated tip
- With hanging hole

- Material Blade: Molybdän Vanadium
- Surface Blade: Matt chrome finished

Art. Code	mm	mm	l mm	l1 mm	l2 mm	g
0640 0840	0.8	4.0	75	25	50	36
0640 1265	1.2	6.5	75	25	50	42



Screwdriver, short (PH)

- For working in places with difficult access
- With black phosphated tip
- With hanging hole

- Material Blade: Molybdän Vanadium
- Surface Blade: Matt chrome finished

Art. Code	l mm	l1 mm	l2 mm	g
0641 0010 PH 1	75	25	50	38
0641 0020 PH 2	75	25	50	41



MATADOR Screwdriver with striking cap.

Punch the head.

Ergonomic handle for effortless working.



Hexagon blade for spanner support.

Burnished tip for precise, durable fitting into the screw.



■ Screwdrivers with wooden handle (Slot)



- Workshop screwdrivers with shovel-shaped tip
 - With go-through blade and striking cap
 - From 1,0 x 5,5 mm with hexagon blade for torque increase together with a spanner
 - Burnished tip
 - Wooden handle made of sealed beech wood, handle end protected from damage through hammer impact by a leather cap
 - Forged round blade
- Standards: DIN ISO 2380-2 / tip to DIN ISO 2380-1 Form A
 - Material Blade: Chrome Vanadium
 - Surface Blade: Matt chrome finished

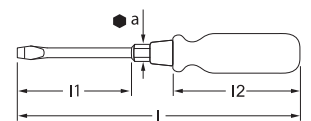

Art. Code	mm	mm	a mm	l mm	l1 mm	l2 mm	g
0600 0635	0,6	3,5		170	75	95	50
0600 1610	1,6	10,0	13	300	175	125	206
0600 2514	2,5	14,0	16	380	250	130	296

■ Screwdrivers with wooden handle (Cross head PH)



- Workshop screwdrivers
- With go-through blade and striking cap
- With hexagon blade for torque increase together with a spanner
- Burnished tip
- Wooden handle made of sealed beech wood, handle end protected from damage through hammer impact by a leather cap
- Forged round blade

- Standards: DIN ISO 8764-2 / tip to DIN ISO 8764-1 PH
- Material Blade: Chrome Vanadium
- Surface Blade: Matt chrome finished

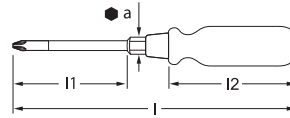

Art. Code		a mm	l mm	l1 mm	l2 mm	g	
0650 0010	PH 1	6	175	80	95	58	10
0650 0020	PH 2	10	210	100	110	92	10
0650 0030	PH 3	13	270	150	120	165	10
0650 0040	PH 4	16	330	200	130	291	5



Screwdriver Sets.

Practical and proven assortments.



2C-Screwdriver set L

2K

- 6 pcs. set of screwdrivers
- All important sizes in one set

- Set in practical, transparent polypropylene box: robust packaging, stackable and easy to stock, reclosable, reusable



Art. Code	g	
0680 9060	520	1
0615 0.6 x 4.0 x 75 - 0.8 x 5.0 x 100 - 1.0 x 5.5 x 125 - 1.2 x 6.5 x 150 mm		
0655 PH 1 x 80 - PH 2 x 100 mm		

2C-Screwdriver set XL

2K

- 8 pcs. set of screwdrivers including voltage
- tester and carburettor screwdriver
- All important sizes in one set

- Set in practical, transparent polypropylene box: robust packaging, stackable and easy to stock, reclosable, reusable





Art. Code	g	
0680 9080	590	1
0615 0.6 x 4.0 x 75 - 0.8 x 5.0 x 100 - 1.0 x 5.5 x 125 - 1.2 x 6.5 x 150 mm		
0655 PH 1 x 80 - PH 2 x 100 mm		
0635 0.5 x 3.0 x 65 mm		
0640 0.8 x 4.0 x 25 mm		

2C-Screwdriver set (TORX®)

2K  

- 6 pcs. set of screwdrivers for recessed TORX® head screws
- All important sizes in one set
- Set in practical, transparent polypropylene box: robust packaging, stackable and easy to stock, reclosable, reusable











		
Art. Code	g	
0620 9060 	520	1
 0620  T10 - T15 - T20 - T25 - T27 - T30		

Wooden handle Screwdriver set

- 6 pcs. set of screwdrivers with wooden handle, with go-through blade and striking cap
- All important sizes in one set
- Set in practical, transparent polypropylene box: robust packaging, stackable and easy to stock, reclosable, reusable



		
Art. Code	g	
0650 9060 	530	1
 0600  0.8 x 4.5 x 90 - 1.0 x 5.5 x 100 - 1.2 x 8.0 x 150 - 1.6 x 10 x 175 mm		
 0650  PH 1 x 80 - PH 2 x 100 mm		

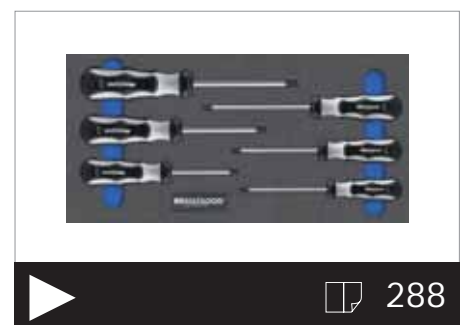
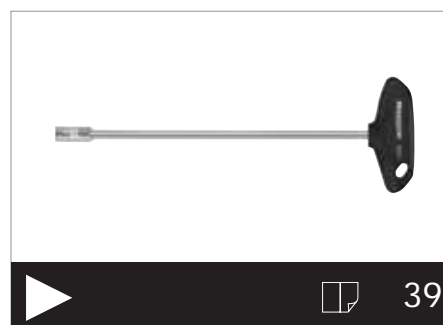
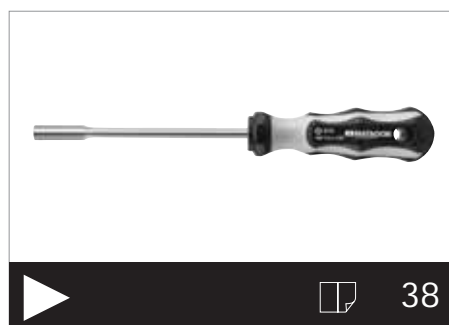

Precision Screwdrivers with 2-component handle.

Indispensable for all precision-mechanical work.



■ 2C-Precision screwdriver (Slot)

2K

- For all precision-mechanical work
- With turnable cap and 2-component handle with hard turning zone and soft grip zone
- With burnished tip

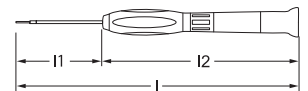

Art. Code	mm		mm			g	
	l mm	l1 mm	l2 mm	g	g		
0661 0251	0.25	1.0	150	50	100	10	10
0661 0420	0.40	2.0	150	50	100	10	10
0661 0530	0.50	3.0	150	50	100	10	10

■ 2C-Precision screwdriver (PH)

2K

- For all precision-mechanical work
- With turnable cap and 2-component handle with hard turning zone and soft grip zone
- With burnished tip

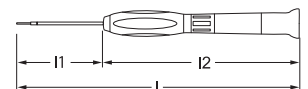

Art. Code	mm		g			
	l mm	l1 mm	l2 mm	g		
0662 0000	PH 00	150	50	100	10	10
0662 0001	PH 0	150	50	100	10	10
0662 0010	PH 1	150	50	100	10	10

2C-Precision screwdriver (TORX®)

2K 

- For all precision-mechanical work
- With turnable cap and 2-component handle with hard turning zone and soft grip zone
- With burnished tip

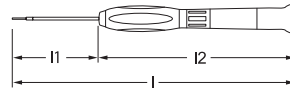

Art. Code	l mm	l1 mm	l2 mm	g	
0663 0050 T5	150	50	100	10	10
0663 0060 T6	150	50	100	10	10
0663 0070 T7	150	50	100	10	10
0663 0080 T8	150	50	100	10	10
0663 0100 T10	150	50	100	10	10
0663 0150 T15	150	50	100	10	10

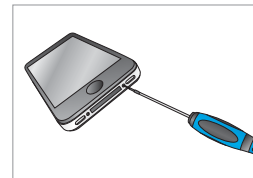

2C-Precision screwdriver set

- 6 pcs. set of precision screwdrivers
- All important sizes in one set
- Set in practical, transparent polypropylene box: robust packaging, stackable and easy to stock, reclosable, reusable

Art. Code	g	
0662 9060 	70	1
 0661  0.25 x 1.0 - 0.4 x 2.0 - 0.5 x 3.0 mm		
 0662  PH 00 - PH 0 - PH 1		



2C-Precision screwdriver set (TORX®)

2K  

- 6 pcs. set of precision screwdrivers for recessed TORX® head screws
- All important sizes in one set
- Set in practical, transparent polypropylene box: robust packaging, stackable and easy to stock, reclosable, reusable

Art. Code	g	
0663 9060 	70	1
 0663  T5 - T6 - T7 - T8 - T10 - T15		



Reversible Screwdrivers by MATADOR.

Handy helpers to go.

4 penny

Reversible bits made of tool steel.



Practical shirt clip.

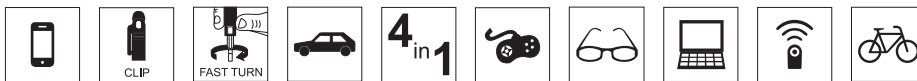

■ Mini-Screwdriver 4in1

- Exceptionally practical pen screwdriver
- With 2 removable caps, each with a removable bit
- 4 screwdrivers in one tool
- Provides window for quick identification of the inserted bit
- A perfect combination of precise technology and standard screwdriver
- Suitable for glasses, mobile phones, remote controls, computers, toys, bicycles, cars and all kinds of repair in general
- Blade made of tool steel

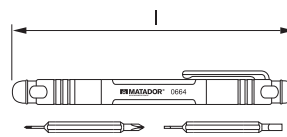

Art. Code	mm		l mm	g	
0664 0001	1,5 - 3,0	PH 00 - PH 0	130	10	10

■ Reversible Screwdriver ECO

- Practical reversible screwdriver in standard quality (on-board tool)
- Handle made of black plastic
- Blade made of tool steel

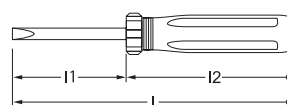

Art. Code	mm		l mm	l1 mm	l2 mm	g	
0694 0001	1,2 x 6,0	PH 2	165	65	100	45	10



Impact Screwdriver and Bits.

For turning every screw.

Very handy, only 185 mm total length including bit.

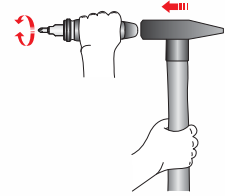

With 12.5 mm (1/2") square drive for sockets or bits (with adaptor).

1/2" 12.5 mm



Including bit adaptor.

8 mm 5/16"



Hand Impact Screwdriver Set

- For loosening jammed screws or nuts
- Set with the most important bits with 8 mm (5/16") external hexagon
- In solid metal case with MTS inlay

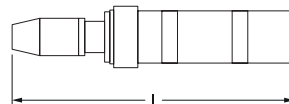

Art. Code	l mm	g	
0696 0001	160	1300	1

- 0696
- 7026 1,6 x 8,0 x 35 - 1,6 x 10,0 x 35 - 2,0 x 12,0 x 35 mm
- 7027 PH 2 - PH 3 - PH 4
- 7028 5 - 6 - 8 mm
- 7032 T40 - T45 - T50 - T55

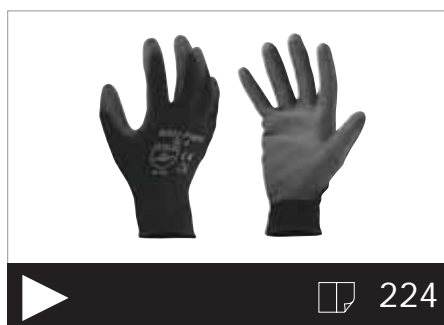

Hex Power Shank



- For use with power screwdrivers

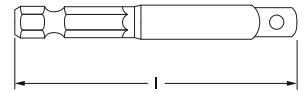

Art. Code	mm	"	mm	"	l mm	g	
2085 0001	6.3	1/4	6.3	1/4	50	15	5

Hex Power Shank



- For use with power screwdrivers

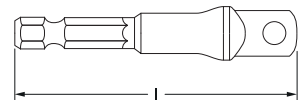

Art. Code	mm	"	mm	"	l mm	g	
3085 0001	6.3	1/4	10.0	3/8	75	25	5

Hex Power Shank



- For use with power screwdrivers

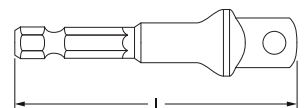

Art. Code	mm	"	mm	"	l mm	g	
4085 0001	6.3	1/4	12.5	1/2	75	30	5

Bitholder



- To use 1/4"-Bits with heavy-duty applications, e.g. AEG, Bosch, Metabo, Holzher, Black & Decker
- With magnet

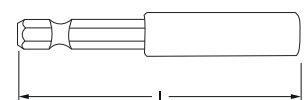

Art. Code	mm	"	mm	"	l mm	g	
7040 0001	6.3	1/4	6.3	1/4	58	27	5



MATADOR torsion bitbox.

For cordless and impact screwdrivers.



Bit Assortment TORSION

- Assortment with 30 Bits
- Superior lifetime
- Equally suitable for cordless and impact screwdrivers
- Absorbs the power peaks and thus ensures more elasticity
- In plastic box
- With belt clip

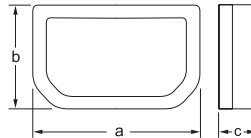

Art. Code	b mm	a mm	c mm	g	
7052 0003	70	105	40	95	1
7026	6.3 (1/4) 3 - 4 - 5 - 6 mm				
7027	6.3 (1/4) PH 1 - 2 x PH 2 - PH 3				
7027	6.3 (1/4) PZ 1 - 2 x PZ 2 - PZ 3				
7028	6.3 (1/4) 3 - 4 - 5 - 6 mm				
7032	6.3 (1/4) T10 - T15 - T20 - T25 - T27 - T30 - T40				
7033	6.3 (1/4) T10 - T15 - T20 - T25 - T27 - T30 - T40				
2062	6.3 (1/4) 60 mm				
2062	6.3 (1/4)				

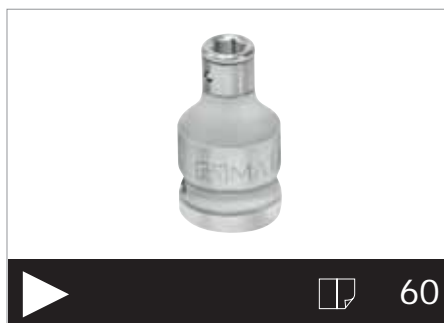
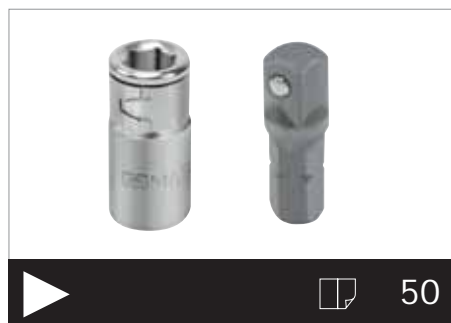

Miscellaneous Tools.

Be a MATADOR.



Content Miscellaneous Tools.

Page Article group



Hammers.

- 183 Engineer's Hammers
- 183 Spare Handles
- 183 Spare Collars
- 184 Club Hammers
- 184 Copper Hammers
- 184 Sledge Hammers
- 185 Rubber Mallets, soft
- 185 Plastic Hammers
- 187 Non-rebound Mallets
- 187 Spare Faces
- 187 Spare Handles



Striking tools.

- 188 Number Punches
- 188 Letter Punches
- 189 Arch Punches
- 191 Flat Cold Chisels
- 192 Cross-cut Chisels
- 192 Center Punches
- 193 Drift Punches
- 194 Parallel Pin Punches
- 195 Parallel Pin Punches XXL
- 195 Tool Set
- 197 Parallel Pin Punches PRO
- 197 Hand protecting grip



Bench vices.

- 198 Parallel Bench Vice, forged
- 199 Tube and protective jaws (aluminum)
- 199 Tube and protective jaws (plastic)
- 199 Combination stepped key



Pullers.

- 202 Pullers, 2 arms
- 202 Universal Pullers, 2 arms
- 203 Universal Pullers
- 204 Pullers, 3 arms
- 204 Pullers, 3 arms, heavy duty
- 205 Universal Pullers, 3 arms
- 206 Battery Terminal Pullers, 2 legs
- 206 Separators with Pulling Device
- 207 Ball Joint Puller
- 207 Universal Ball Joint Puller

Page Article group



Cutting tools.

- 208 Universal knife PRO
- 208 Spare blades
- 209 Cable Knife with wooden handle
- 209 Universal knife ECO
- 209 Household Scissors
- 210 Telephone and Cable Scissors
- 210 Dulf Ideal Tin Snips
- 211 Ideal Lever Tin Snips



Saws.

- 212 Hacksaw
- 213 High performance saw blades
- 213 Hacksaw



Files.

- 213 Steel wire brush
- 214 Engineers' Files
- 215 Set of Warding Files
- 215 Set of Contact Files



Scraper.

- 216 Curved Bearing Scraper
- 216 Three-Edged Hollow Ground Scraper
- 217 Flat scraper
- 217 Gasket scraper
- 217 Multi Purpose / Glass Scraper



Twist drill.

- 218 Twist drill assortments
- 219 Hand Taps HSS
- 219 Set of circular dies HSS
- 220 Thread Gauges
- 220 Screw Extractor Sets
- 221 Tap wrenches
- 221 Screw Extractor ScrewIT

Page Article group



Measuring tools.

- 222 Feeler Gauges
- 222 Measuring Tape
- 222 Rules, flexible
- 223 Rules, non flexible
- 223 Spirit Level
- 223 Precision Vernier Caliper
- 224 Electronic Caliper
- 224 Hard Metal Marking Tool



Diverse.

- 224 Knee pads
- 224 Micro fine woven gloves
- 225 Mini Magnetic Pick Up Tool
- 225 Magnetic Pick Up Tools
- 225 Gripping Tool with Claw
- 226 Hopper
- 226 Plastic Oiler
- 226 Precision Oiler
- 227 Lever Grease Gun TWIN LOCK
- 227 Talc
- 227 Graphite
- 227 Rust remover
- 227 Brake cleaner

MATADOR Hammers.

Safe, ergonomically designed and convenient.
Strike by strike.

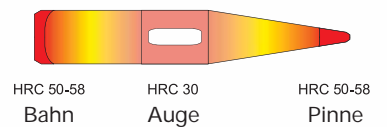
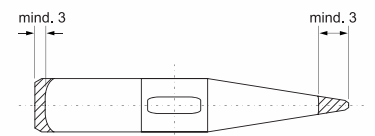
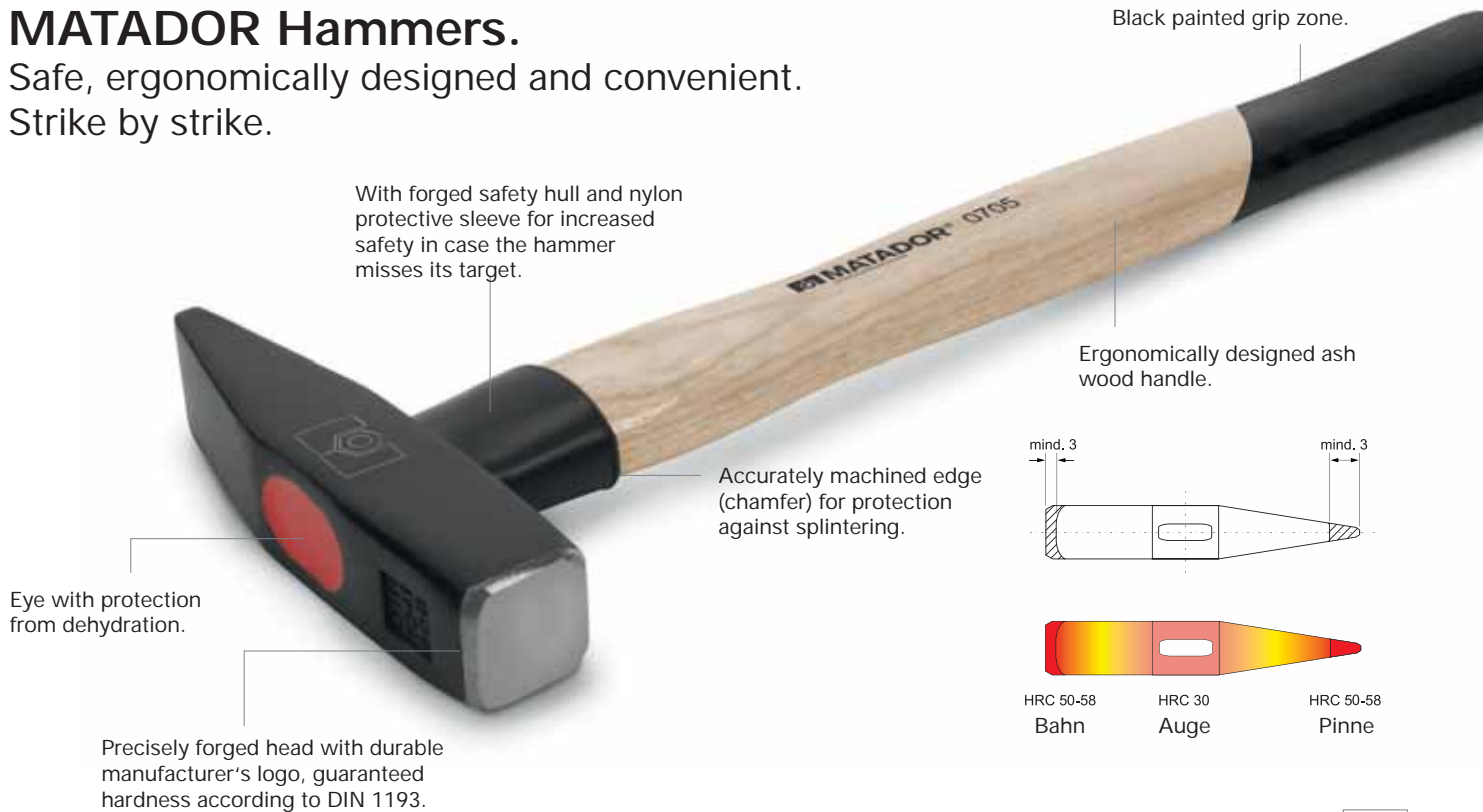

Secure fitting of handle and hammer head.

On principle MATADOR hammer handles are fitted to the hammer head by a ring wedge.

Other than a flat wedge the ring wedge presses the handle wood evenly to all sides to the eye of the hammer head and thus allows a tight fit. The integrated barbed hook makes sure that the hammer head does not become loose unintentionally even after several hundreds of blows.

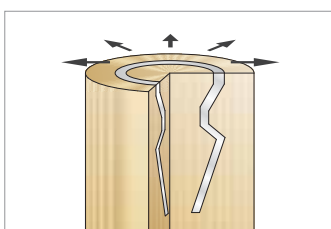

Controlled hardness and perfect cut.

Hammers have to have the „right“ hardness. According to DIN 1193 the hardness at the face (the flat end) and peen has to be 50 - 58 HRC. This value makes sure that the hammer is not too hard to avoid splintering when in use. On the other hand the head must not be too soft as buckles and beads at the face would occur.

Moreover DIN 1193 defines the cut of the two hammer ends: the face has to be chamfered all-round. The peen should be evenly blunt and chamfered at the sides.

MATADOR hammers are ground fully automatically on state-of-the-art machines and thus ensure a perfect protection from splintering even under heavy stress.

Only certified wood.

The right wood for striking tools is regulated under DIN 68340. Preferred wood types are hickory and ash. For our hammers with wooden handle we only use ash or hickory wood from controlled cultivation.

Ash is the most common wood type used for quality hammers. Ash is relatively inexpensive break resistant to a large extent short-fibered in structure.

In case of breakage the ash handle breaks in two parts because at the break line the wood cannot be held together.

Hickory, on the contrary, has longer fibers and is thus 3 to 4 times steadier and more elastic (= more stress-resistant) than ash. However, it is also more expensive.

Safety Instructions.



- Always wear eye protection goggles and protective gloves.
- For optimal impact the position for your hands on the handle should be as far as possible away from the hammer head.
- Always keep the hammer handle free from lubricants.
- Never misuse a hammer as a lever.
- Only use the work faces of a hammer. Never use the sides.
- Do not store hammers with wooden handles in a warm and dry environment. The hammer might lose moisture and shrink. Before using the hammer please check that the hammer head is tightly and securely fitting to the shaft.
- Never use steel hammers to work on workpieces with a hardness exceeding 46 HRC. For this purpose use MATADOR plastic hammers or non-rebound hammers.

Engineer's Hammers

- German pattern
- Forged hammer head
- Induction hardened
- Sideways smoothed and epoxy powdered
- Handle fixed with round steel wedge and resin
- With safety collar (tapered)

- Standards: DIN 1041 / handle DIN 5111
- Material: Head C 45, handle ash
- Surface: Black painted hand end

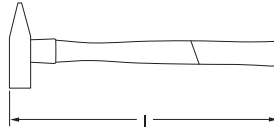

Art. Code	g	l mm	g	g
0705 0200	200	275	250	6
0705 0300	300	300	370	6
0705 0400	400	310	460	6
0705 0500	500	320	590	6
0705 0800	800	350	910	2
0705 1000	1000	355	1170	2
0705 1500	1500	380	1700	2
0705 2000	2000	400	2285	1

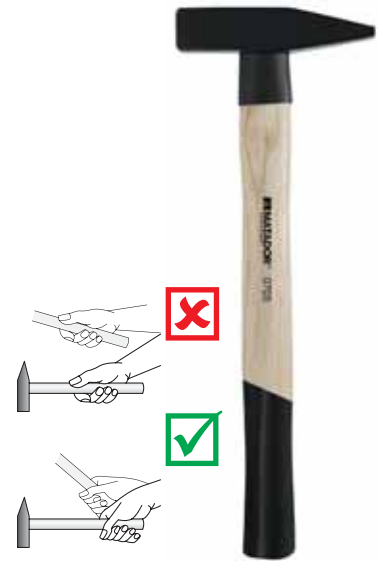

Spare Handles

- Ash handle for engineer's hammers
- Standard: DIN 5111
- Material: Ash

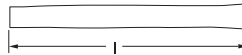

Art. Code	g	l mm	g	g
0705 0201	200	275	57	6
0705 0301	300	300	71	6
0705 0401	400	310	100	6
0705 0501	500	320	105	6
0705 0801	800	350	149	2
0705 1001	1000	355	157	2
0705 1501	1500	380	185	2
0705 2001	2000	400	285	1



Spare Collars

- Collars for engineer's hammers

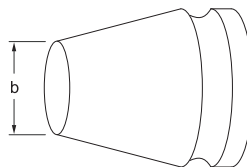

Art. Code	g	b mm	g	g
0705 0202	200	8	2	6
0705 0302	300	9	2	6
0705 0402	400	10	3	6
0705 0502	500	12	4	6
0705 0802	800	14	7	2
0705 1002	1000	15	8	2
0705 1502	1500	15	8	2
0705 2002	2000	16	11	1



■ Club Hammers



- German pattern
 - Forged hammer head
 - Induction hardened
 - Sideways smoothed and epoxy powdered
 - Handle fixed with round steel wedge and resin
 - With safety collar (tapered)
- Standard: DIN 6475 / Handle DIN 5135
 - Material: Head C 45, handle ash
 - Surface: Black painted hand end

Art. Code	g	l mm	g	
0707 1000	1000	260	1180	1
0707 1500	1500	280	1690	1
0707 2000	2000	300	2200	1

■ Copper Hammers



- For non-sparking stroke
- Forged hammer head
- Handle fixed with round steel wedge
- Ash handle

Art. Code	g	l mm	g	
0708 0300	300	260	370	6
0708 0500	500	270	600	6
0708 0800	800	280	900	2
0708 1000	1000	280	1100	2

■ Sledge Hammers



- Forged hammer head
 - Sideways smoothed and epoxy powdered
 - Handle fixed with round steel wedge and resin
 - With safety collar (tapered)
- Standard: DIN 1042 / Handle DIN 5112
 - Material: Head C 45, handle ash
 - Surface: Hand end black painted

Art. Code	g	l mm	g	
0711 0300	3000	610	3500	1
0711 0400	4000	710	4600	1
0711 0500	5000	810	5600	1
0711 0600	6000	810	6500	1
0711 0800	8000	910	8500	1
0711 1000	10000	910	10500	1

■ Rubber Mallets, soft

- Soft version according to DIN 5128-60
- 60 Shore D hardness
- With two flat surfaces
- With ash handle

- Standard: DIN 5128-60
- Material: Head rubber, handle ash

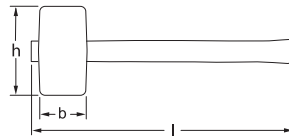

Art. Code	h mm	b mm	l mm	g	
0738 0001	90	54	320	300	1
0738 0002	113	64	340	520	1
0738 0003	127	74	380	770	1
0738 0004	139	90	380	1150	1

- Soft version according to DIN 5128-60
- With one flat and one curved surface
- With ash handle

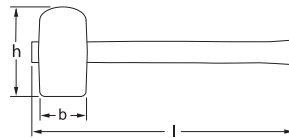

Art. Code	h mm	b mm	l mm	g	
0738 0005	113	64	340	520	1

■ Plastic Hammers

- With exchangeable heads made from red shatter-proof cellulose acetate
- 65 Shore D hardness
- With ash handle

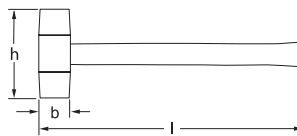

Art. Code	h mm	b mm	l mm	g	
0700 0001	75	22	255	150	6
0700 0002	90	27	270	200	6
0700 0003	97	32	280	350	6
0700 0004	103	35	290	450	6
0700 0005	111	40	320	600	2
0700 0006	120	50	340	900	2

- Spare heads (1 pair)

- Please heat up before assembly

Art. Code	b mm	g	
0700 1001	22	30	6
0700 1002	27	30	6
0700 1003	32	35	6
0700 1004	35	60	6
0700 1005	40	65	2
0700 1006	50	130	2



Recoilless Hammers. Higher impact than standard hammers due to special filling.

Joint-friendly with high impact.

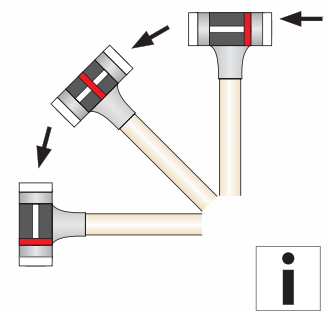

Practically no recoil.

In jobs where hammers are used frequently wrists, tendons and muscles are exposed to very high stress when working with standard steel hammers.

MATADOR recoilless hammers are thus perfect problem solvers that - thanks to their special filling in the hammer head - allow practically recoilless work.

Tests with a 500 g hammer have shown that the vibrational stress at the handle in a blow on steel is reduced by more than 65%. At the same time the kinetic energy of the steel shot inside the hammer head increase the impact by more than 20% compared to standard steel hammers.

More impact with less effort.

Especially wear-resistant hammer faces.

MATADOR hammer faces are made of semi-hard polyurethane and are at the same time colorfast and resistant to wear.

The splinterproof faces are easily exchangeable so that the hammer still keeps its original strenght even after intense use.

Cost-saving and health-friendly.

MATADOR recoilless hammers go easy on your budget as well as on your health.

In most cases they can even replace the classical engineer's hammer and are definitely the more intelligent choice.

Why more comfort?

MATADOR recoilless hammers are filled with special steel shots inside the hammer head.

During each blow the steel balls make for 25% more mass and thus give the blow additional impact. After the blow the hammer head practically „sticks“ to the workpiece and there is no recoil, especially on hard workpieces. Recoilless hammers go easy on your wrists and tendons.



Practically recoilless and precise blows.

Safety Instructions:

Always wear eye protecting goggles and protective gloves!



■ Non-rebound Mallets

- With hickory handle
- With exchangeable splinter-proof, shatter-proof and wear-resistant nylon faces
- For automobile assembly and repair work, positioning of work pieces in the vice, tent and hall construction, car body work, repair and maintenance work, straightening work, housing assembly, assembly of sharp-edged work pieces, joining of work pieces, sheet

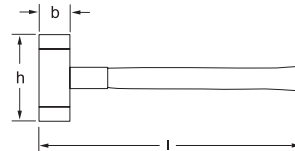

Art. Code	h mm	h "	b mm	b "	l mm	l "	g
0702 0300	110	4,32	30	1,18	330	12,95	460
0702 0350	110	4,32	35	1,37	335	13,15	560
0702 0400	115	4,51	40	1,57	360	14,13	715
0702 0500	120	4,71	50	1,96	370	14,52	990
0702 0600	145	5,69	60	2,36	370	14,52	1705



■ Spare Faces

- Spare nylon faces (single)

Art. Code	mm	"	g
0702 0301	30	1,18	17
0702 0351	35	1,37	23
0702 0401	40	1,57	33
0702 0501	50	1,96	55
0702 0601	60	2,36	95

Removal of nylon faces.

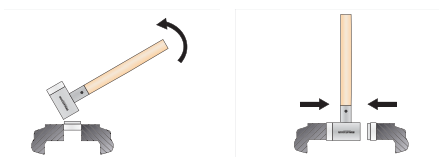

■ Spare Handles

- Spare hickory handles (single)

Art. Code	mm	l mm	g
0702 0302	30	300	100
0702 0352	35	300	100
0702 0402	40	315	140
0702 0502	50	315	140
0702 0602	60	300	190

Removal of handle.

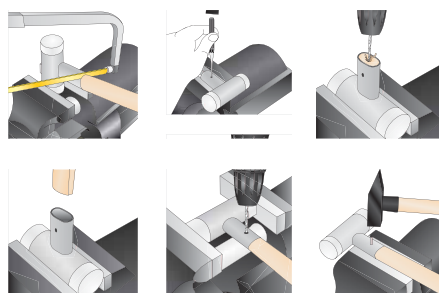

■ Number Punches

- 9 numbers („0 - 9“)
- For labelling work pieces with a strength of 600 - 800 N/mm²
- Hardness at the engraving: 58 - 60 HRC
- In unbreakable, blue plastic box

- Standard: Characters acc. DIN 1451
- Material: Tool steel
- Surface: Silky matt

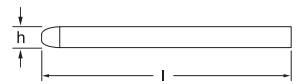

Art. Code	mm	l mm	h mm	g	
0712 0040	4	65	7	200	1
0712 0050	5	65	8	300	1
0712 0060	6	70	9	400	1
0712 0080	8	75	11	600	1

1	2	3
4	5	6
7	8	0

■ Letter Punches

- 27 capital letters („A - Z“, + „&“)
- For labelling work pieces with a strength of 600 - 800 N/mm²
- Hardness at the engraving: 58 - 60 HRC
- In unbreakable, blue plastic box

- Standard: Characters acc. DIN 1451
- Material: Tool steel
- Surface: Silky matt

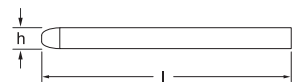

Art. Code	mm	l mm	h mm	g	
0712 1040	4	65	7	600	1
0712 1050	5	65	8	800	1
0712 1060	6	70	9	1200	1
0712 1080	8	75	11	1850	1

A	B	C	D	E	F	G	H	I
J	K	L	M	N	O	P	Q	R
S	T	U	V	W	X	Y	Z	&

MATADOR Arch Punches.

Ideal for repair of soft materials.

For stamping out felt, carpets, leather, rubber, sealing materials and other soft materials.



Cutting edge hardened to 47 - 52 HRC.



Shaft evenly machined and red lacquered.

Entirely forged.

Arch Punches

- Standard: DIN 7200 Form A
- Material: C 35 / C 45
- Surface: Red lacquered

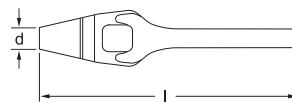

Art. Code	d mm	d "	l mm	g	
0713 0030	3	1/8	105	47	10
0713 0040	4	5/32	105	48	10
0713 0050	5	3/16	110	55	10
0713 0060	6	7/32	110	68	10
0713 0070	7	1/4	120	92	10
0713 0080	8	5/16	120	95	10
0713 0100	10	3/8	130	129	10
0713 0120	12	15/32	130	135	10
0713 0140	14	9/16	140	169	5
0713 0150	15	19/32	140	173	10
0713 0160	16	5/8	140	175	5
0713 0170	17	21/32	145	226	10
0713 0180	18	11/16	145	228	10
0713 0200	20	25/32	160	317	5
0713 0220	22	7/8	160	313	5
0713 0250	25	1	170	388	5

- All important arch punches in practical roll bag made of black synthetic leather

- With strap sealing, 8 compartments

Art. Code	g
0713 9080	1475

Content: 0713 3 - 6 - 8 - 10 - 12 - 16 - 20 - 25 mm



MATADOR Striking Tools.

Hot forged and hardened as a whole.



Tried and tested industrial quality for long service life.

It goes without saying that MATADOR striking tools comply with the DIN standards with respect to their form and workmanship.

Chisels, center punches, drift punches and parallel pin punches are made of a special chrome vanadium air hardening steel. All striking tools are entirely quenched and tempered and thus resist hard working stress and guarantee an especially long service life.

Thanks to the additional inductive hardening of the striking head to 35 - 46 HRC no splintering and beading will occur.

Even in hard industrial working stress MATADOR striking tools will not break.

In case of low wear: Regrinding.

Dulled edges can be reground several times. Make sure that grinding intervals are short and avoid excessive grinding heat in order not to impair the hardness (ideal: water cooling).

In case of heavy wear: Reforging.

In case of heavy wear and tear the cutting edges can be reforged at any time: Pay attention to the right heating of the forging range (cutting edge + 30 mm) up to 950 - 1050°C. The optimal hardening temperature is 790 - 880°C, then immediately quench in oil and heat up to a temperature of approx. 280°C. Ready.

Safety Instructions.

The following working safety requirements should be strictly observed due to high risk of injury involved in the improper use of hand striking tools:

- Always wear eye protection goggles.
- Select the right striking tool and the appropriate hammer size depending to the application.
- Avoid working on hardened material exceeding 40 HRC due to the risk of being seriously injured through splintering.
- Avoid the striking head to be soiled by lubricants.
- Remove burrs at the striking head regularly through grinding.
- Check the cutting edge of the tool before starting to work. Worn cutting edges have to be reground.
- Only use striking tools for their intended purpose.



Flat Cold Chisels

- For general and coarse chiselling work at brickwork, concrete or massive stone
- With regrindable cutting edge
- Through-hardened cutting edge
- Standard: DIN 6453
- Material: Special chrome vanadium air hardening steel

- Surface: Black lacquered

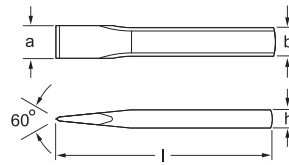

Art. Code	l mm	a mm	b x h mm	g
0714 0125	125	18	17 x 11	150
0714 0150	150	18	17 x 11	205
0714 0175	175	21	20 x 12	280
0714 0200	200	24	23 x 13	370
0714 0250	250	25	23 x 13	500
0714 0300	300	26	23 x 13	600



Flat Cold Chisels with Hand Protecting Grip

- For effective hand protection if hammer misses its target
- Protecting grip made of impact-resistant plastic
- Ergonomic design
- Extra broad protection plate
- No rolling away through cornered design
- With flat cold chisels for general and coarse chiselling work at brickwork, concrete or massive stone
- With regrindable cutting edge

- Through-hardened cutting edge
- Standard: DIN 6453
- Material: Special chrome vanadium air hardening steel
- Surface: Black lacquered

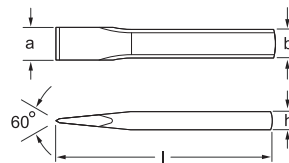

Art. Code	l mm	a mm	b x h mm	g
0714 1250	250	25	23 x 13	605



Flat Cold Chisels, Set

- All important flat cold chisels in practical roll bag made of black synthetic leather
- With strap sealing, 5 compartments

- Standard: DIN 6453
- Material: Special chrome vanadium air hardening steel
- Surface: Black lacquered

Art. Code	g
0714 9050	1500

Content: 0714 125 - 150 - 175 - 200 - 250 mm



■ Cross-cut Chisels



- For cutting metal
- For narrow grooves or inner edges
- With regrindable cutting edge
- Through-hardened cutting edge
Standard: DIN 6451
- Material: Special chrome vanadium air hardening steel

- Surface: Black lacquered

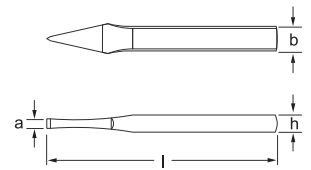

Art. Code	l mm	a mm	b x h mm	g
0715 0125	125	5	17 x 11	100
0715 0150	150	6	17 x 11	180
0715 0175	175	7	17 x 11	210
0715 0200	200	8	20 x 12	340
0715 0250	250	9	23 x 13	455



■ Center Punches



- For marking drilling positions on metal surfaces
- Ideal as centering support
- With ground and polished surface
- Through-hardened cutting edge

- Standard: DIN 7250
- Material: Special chrome vanadium air hardening steel
- Surface: Black lacquered

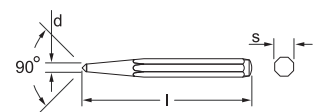

Art. Code	d mm	s mm	l mm	g
0717 0040	4	10	120	70
0717 0050	5	12	120	105

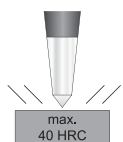

■ Drift Punches

- For punching holes into steel sheets
 - With ground and polished surface
 - With octagonal shaft
 - Through-hardened cutting edge
- Standards: DIN 6458 Form B / D
 - Material: Special chrome vanadium air hardening steel
 - Surface: Black lacquered

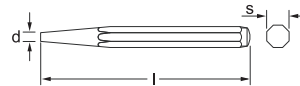

Art. Code	d mm	s mm	l mm	g	
0716 0030	3	10	120	70	10
0716 0040	4	10	120	70	10
0716 0050	5	10	120	80	10
0716 0100	10	12	150	150	5



■ Drift Punches, Set

- All important drift punches in practical black plastic holder
 - For punching holes into steel sheets
 - With ground and polished surface
 - With octagonal shaft
 - Through-hardened cutting edge
- Standards: DIN 6458 Form B / D
 - Material: Special chrome vanadium air hardening steel
 - Surface: Black lacquered

6



Art. Code	g
0716 9060	1500

Content 0716 3 - 4 - 5 - 6 - 8 - 10 mm



Parallel Pin Punches



- For punching fastening elements like rivets, pins or bolts
- With ground and polished surface
- With rounded edges
- Through-hardened cutting edge

- Standard: DIN 6450 Form C
- Material: Special chrome vanadium air hardening steel
- Surface: Black lacquered

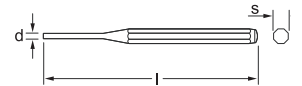

Art. Code	d mm	s mm	l mm	g
0718 0020	2	10	150	65
0718 0030	3	10	150	70
0718 0040	4	10	150	70
0718 0050	5	10	150	75
0718 0060	6	10	150	80
0718 0080	8	12	150	115
0718 0100	10	12	150	125

Parallel Pin Punches, Set



- All important parallel pin punches in practical black plastic holder

- Standard: DIN 6450 Form C
- Material: Special chrome vanadium air hardening steel
- Surface: Black lacquered

Art. Code	g
0718 9060	800

Content 0718 2 - 3 - 4 - 5 - 6 - 8 mm

Parallel Pin Punches, Set



- All important parallel pin punches in practical folding metal box

- Standard: DIN 6450 Form C
- Material: Special chrome vanadium air hardening steel
- Surface: Black lacquered



Art. Code	g
0718 9160	800

Content 0718 2 - 3 - 4 - 5 - 6 - 8 mm

Parallel Pin Punches XXL

- Especially for industry and utility vehicles
 - Extra long design
 - Hand protecting grip with 2-component handle
 - For punching fastening elements like rivets, pins or bolts
 - With ground and polished surface
 - With rounded edges
 - Through-hardened cutting edge
- Standard: DIN 6450 Form C
 - Material: Special chrome vanadium air hardening steel
 - Surface: Black lacquered

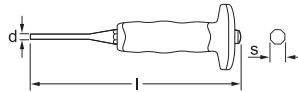

Art. Code	d mm	s mm	l mm	g	
0718 1080	8	14	225	245	5
0718 1100	10	14	240	280	5
0718 1120	12	14	260	325	5
0718 1140	14	18	275	490	5
0718 1160	16	18	290	570	5

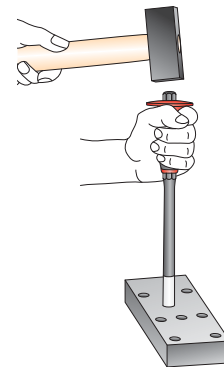

Tool Set

- Flat cold chisels, cross-cut chisel, center punch and taper punches in one set
- Material: Special chrome vanadium air hardening steel
- Surface: Black lacquered

Art. Code	g	
0719 9060	550	1
Content 0714	125, 150 mm	
0715	125 mm	
0716	3, 4 mm	
0717	4 mm	



MATADOR Parallel Pin Punches PRO.

The next level of hardness and durability.

Extremely hard. Secure disassembly with highest precision.

With color system for quick recognition of the correct size.



No splintering thanks to rounded edges.

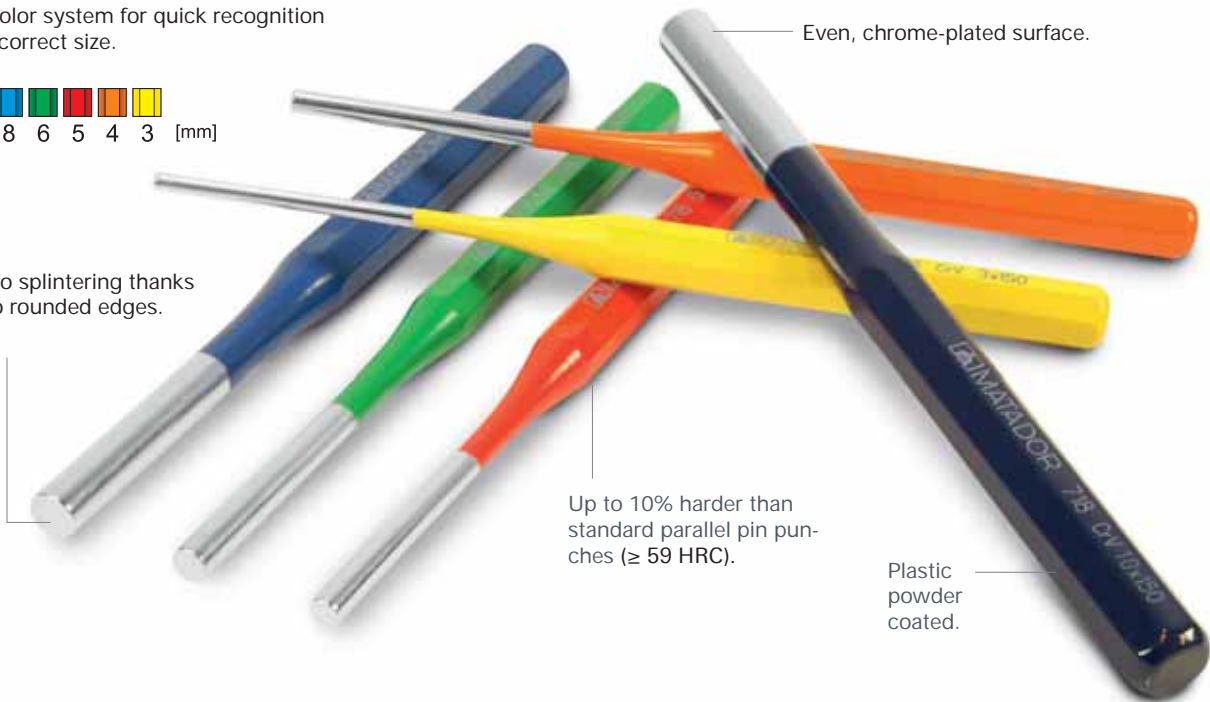

More than meets the eye: Additional hardness.

Underneath their coating MATADOR parallel pin punches come out in their true colors.

Made from high-alloyed tool steel and entirely hardened they are especially suitable for continuous industrial use.

Through the tempered striking head and a hardness of around 59 HRC you can work with MATADOR parallel pin punches in application fields where standard parallel pin punches have long given up. Test yourself!

Rounded edges for increased safety.

All edges of MATADOR parallel pin punches are rounded fully automatically. Splintering and burr at the tip are almost entirely avoided.



This does not only save the work piece but also minimizes the risk of injury for the user. Even if the tools are overstressed they deform elastically and plastically. They do not suddenly break.

Improved surface.

Compared to many competitive products MATADOR parallel pin punches have a grinded, polished and chrome-plated surface.

This results in a low surface roughness which has the following advantages:

- low susceptibility to corrosion
- parallel pin punches can hardly get jammed in the drill hole
- extended service life and elasticity
- hardly any predetermined breaking points as surface notches are evened out

Why PRO?

All MATADOR striking tools are made of special air hardening steel that – after heating to 850 °C – hardens in still air.

The PRO series additionally has a tempered striking head and a chrome-plated and plastic powder coated surface. Thanks to color guidance system the different sizes can easily be recognized.

By the way, all parallel pin punches are produced with minus tolerances and thus jamming in the drill hole is avoided.



Parallel Pin Punches PRO

- All important parallel pin punches PRO in in practical folding metal box
- With ground and polished surface
- With rounded edges
- Through-hardened cutting edge
- Standard: DIN 6450 Form B / D
- Material: Special air hardening steel
air hardening steel
- Surface: Color powder coated



Art. Code	g	
0718 9560	1500	1
Content 0718 3 - 4 - 5 - 6 - 8 - 10 mm		

Hand protecting grip

- Hand protecting grip
- For flat profiles and 8 point material



Art. Code	mm	mm	l mm	g	
0714 0995	20x12 - 26x13	16 - 20	110	105	5

Hand protecting grip

- Hand protecting grip for 8 point material
- With ergonomic 2-component handle



Art. Code	mm	l mm	g	
0716 0995	10	75	15	1
0716 0996	14	95	50	1
0716 0997	18	95	50	1

The MATADOR bench vice. A real classic.

Drop-forged steel and precisely machined.

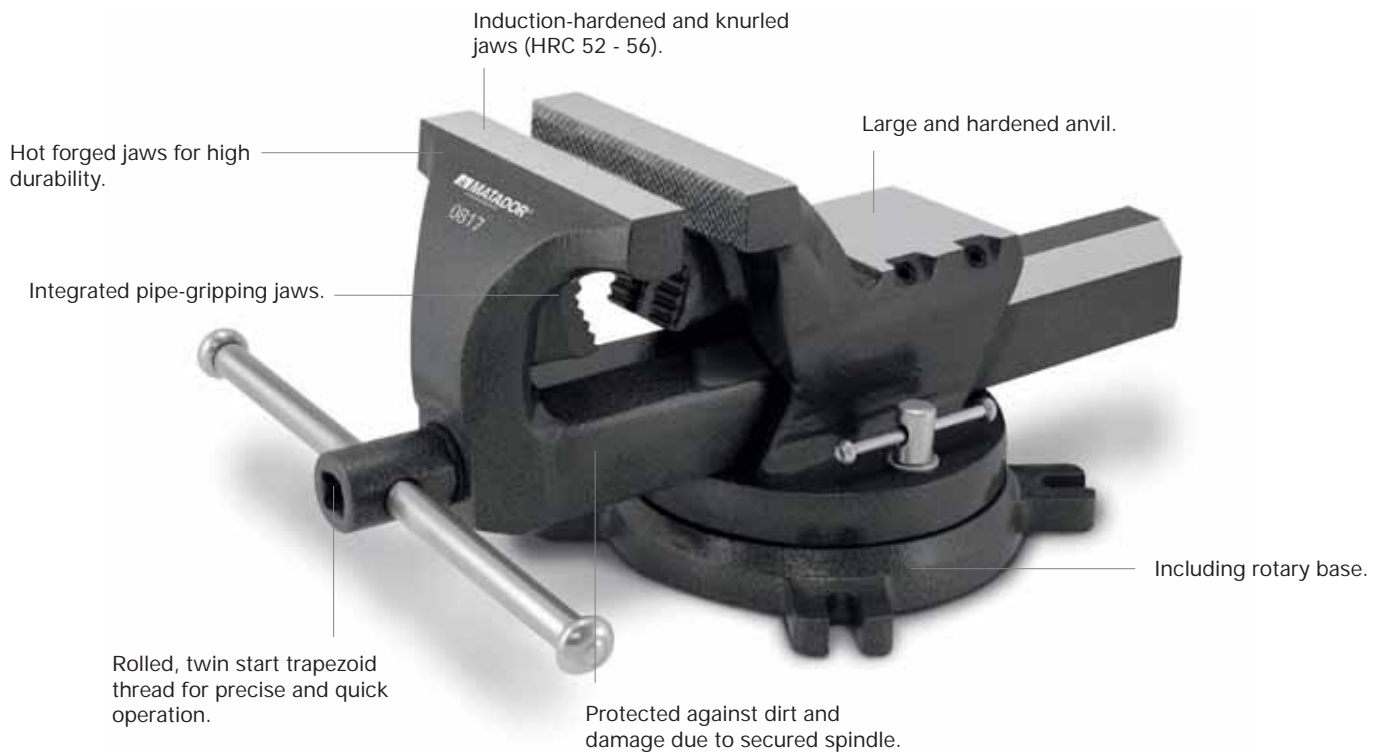

With integrated pipe-gripping jaws.



Adjustable spindle guides for backlash-free operation.



Rotary base easy to fix and remove.



Steel arm easy to remove.

Parallel Bench Vice, forged



- Forged from high-quality steel and completely hardened for long durability
- Induction-hardened and knurled jaws
- Large and hardened anvil
- CNC machined and induction-hardened sliding surface
- Trapezoidal double pitch screw for quick and easy usage
- Integrated pipe-gripping jaws
- Material: Heat treated steel
- Surface: Black varnished

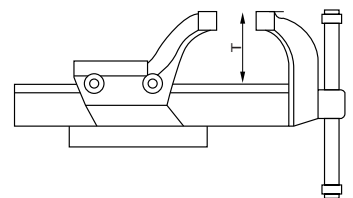
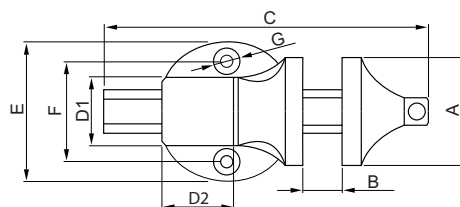

Art. Code	A mm	C mm	B mm	T mm	E mm	F mm	G mm	D1 x D2 mm	kg
0817 0100	100	350	105	60	122	89	10,5	60 x 64	6,4
0817 0125	125	385	130	75	150	108	14,0	72 x 72	11,6
0817 0150	150	490	160	95	180	139	16,5	96 x 90	21,0

■ Tube and protective jaws (aluminum)

- Suitable for all types of vice
- With horizontal prism for round material
- 1 VE = 1 pair

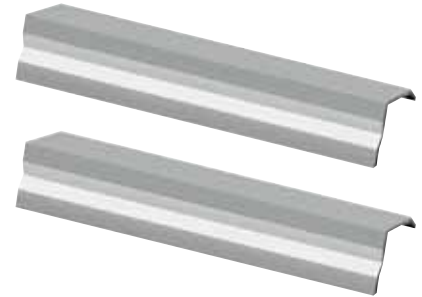

Art. Code	l mm	g	
0818 0101	100	175	1
0818 0102	125	200	1
0818 0103	150	250	1

■ Tube and protective jaws (plastic)

- With magnetic adhesion
- Suitable for all types of vice
- With horizontal and vertical prism for round material
- 1 VE = 1 pair

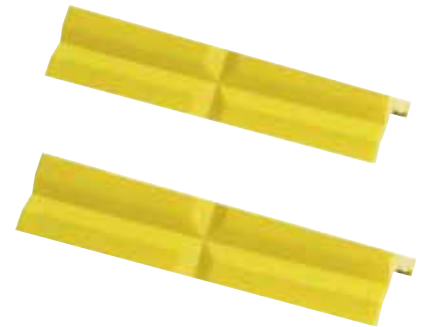

Art. Code	l mm	g	
0818 0201	100	75	1
0818 0202	125	100	1
0818 0203	150	125	1

■ Combination stepped key

12.5 mm 1/2

- For the installation and removal of radiator valves, runback screwed unions 3/8" - 1" and short tap extensions
- With pin, hexagon and bi-hexagon nut drive

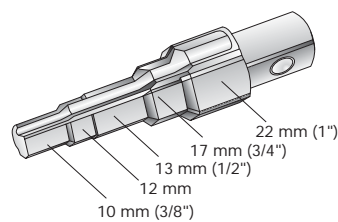

Art. Code	mm	"	g	
2000 0001	12.5	1/2	135	1
2000 0002	12.5	1/2	118	7

1/2"- Adaptor for combination stepped key

The MATADOR pullers.

Solid quality, tried and tested.

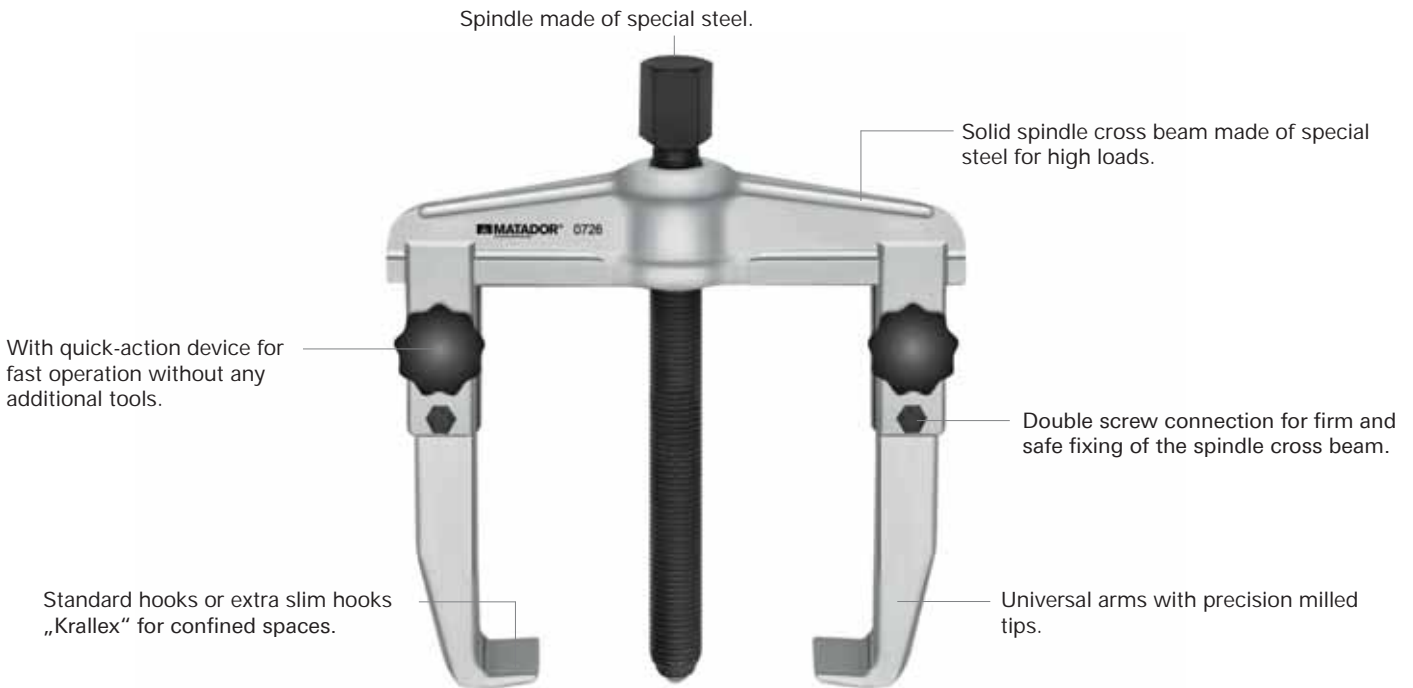

The basics of right pulling:

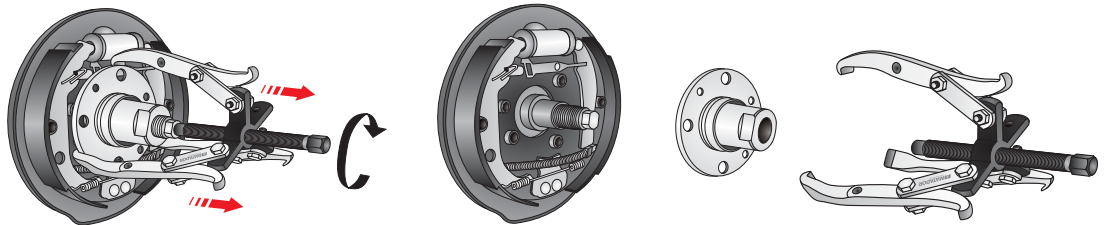

Check the condition of your tools at regular intervals and replace any damaged or worn parts.



Keep the threads of all spindles and heads clean and well oiled.



Before you start work, acquaint yourself with the proper use of the tool and pay attention to pertinent safety measures.



If anything at all is unclear pls. call the MATADOR helpline.



Prior to starting work make sure that the pulling tool is in good condition.

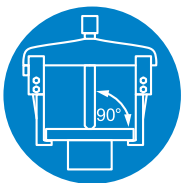

Double-check the tool for correct mounting and monitor the forces incidental to the pulling process.



Never violate the maximum load data prescribed for the tool and use a torque wrench to keep tabs on the applied forces



Always wear suitable personal protective equipment and safety glasses.

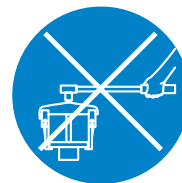

Never use extensions to increase the applied torque.



Never alter a pulling tool or related product in any way.

Overview.

All pullers at a glance.

Pullers, 2 arms.

Standard Pullers:



Art. Code	mm	mm	mm
0722 0002	20 - 150	160	--

Pullers, 3 arms.



Art. Code	mm	mm	mm
0723 0002	20 - 150	160	--

Special pullers.

Battery Terminal Pullers:



Art. Code	mm	mm	mm
0728 0001	50	40	--
0728 0002	70	65	--



Art. Code	mm	mm	mm
0724 0001	20 - 150	85	--
0724 0002	40 - 220	130	--



Art. Code	mm	mm	mm
0725 0001	20 - 150	85	--
0725 0002	40 - 220	130	--

Separators with pulling device:



Art. Code	mm	mm	mm
0727 0050	45 - 140	150	--
0727 0060	55 - 205	210	--

Universal Pullers:



Art. Code	mm	mm	mm
0726 0001	20 - 90	100	70 - 130
0726 0002	25 - 130	100	80 - 180
0726 0003	50 - 160	150	105 - 220
0726 0004	60 - 200	150	120 - 270
0726 0005	80 - 250	200	160 - 330
0726 0006	80 - 350	200	160 - 420

Heavy Duty:



Art. Code	mm	mm	mm
0725 0010	50 - 300	250	--
0725 0011	50 - 400	400	--

Ball Joint Pullers:



Art. Code	mm	mm	mm
0729 0001	18	40	40
0729 0002	25	50	50
0729 0003	29	60	60
0729 0004	40	80	80

Universal Pullers with quick action device:



Art. Code	mm	mm	mm
0726 0101	20 - 90	100	70 - 130
0726 0102	25 - 130	100	80 - 180
0726 0103	50 - 160	150	105 - 220
0726 0104	60 - 200	150	120 - 270



Art. Code	mm	mm	mm
0725 0021	25 - 130	100	70 - 130

Universal Ball Joint Pullers:



Art. Code	mm	mm	mm
0731 0001	18 - 22	50	--

Universal Pullers with Krallex hooks:



Art. Code	mm	mm	mm
0726 0010	20 - 90	100	--
0726 0011	25 - 130	100	--
0726 0012	50 - 160	150	--
0726 0013	60 - 200	150	--



Art. Code	mm	mm	mm
0727 0101	20 - 90	100	70 - 130
0727 0102	25 - 130	100	80 - 180
0727 0103	50 - 160	150	105 - 220
0727 0104	60 - 200	150	120 - 270



Art. Code	mm	mm	mm
0731 0002	24	50	--

Universal Pullers, Krallex, 6 legs:



Art. Code	mm	mm	mm
0726 0050	25 - 130	100, 200, 250	--



Art. Code	mm	mm	mm
0725 0031	25 - 130	100	--



Art. Code	mm	mm	mm
0731 0009	36	90	--



Art. Code	mm	mm	mm
0731 0010	45	115	--

■ Pullers, 2 arms



- For internal pulling
- Arms in 2 lengths for different applications
- Puller legs to be used on both sides: one side with wide, the other side with narrow hooks
- Surface: Zinc plated

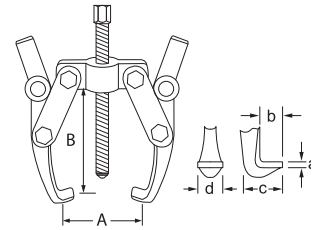

Art. Code	A mm	B mm	max. torque N-m	max. capacity t	Spindles thread x length mm	Legs					kg	1
						mm	mm	mm	mm	mm		
0722 0002	20 - 150	160	80	4,0	M14 x 1,5 x 150	16	2 / 2	7 / 7	17 / 17	10 / 18	1,1	1

■ Pullers, 2 arms



- For internal pulling
- Heavy-duty pattern
- Interchangeable arms to be used on both sides: one side with wide, the other side with narrow hooks
- Surface: Zinc plated

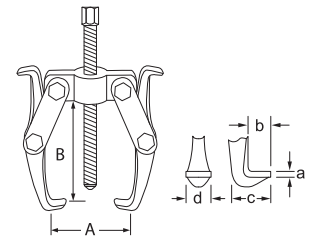

Art. Code	A mm	B mm	max. torque N-m	max. capacity t	Spindles thread x length mm	Legs					kg	1
						mm	mm	mm	mm	mm		
0724 0001	20 - 150	85	50	3,5	M14 x 1,5 x 130	17	2 / 2	9 / 11	21 / 22	12 / 17	0,9	1
0724 0002	40 - 220	130	60	4,0	M18 x 1,5 x 240	19	4 / 4	11 / 11	25 / 27	21 / 27	2,2	1

■ Universal Pullers, 2 arms



- For internal and external pulling
- Interchangeable arms to be used on both sides: one side with wide, the other side with narrow hooks
- Adjustable height for many applications
- With slim hook for confined spaces
- Surface: Zinc plated

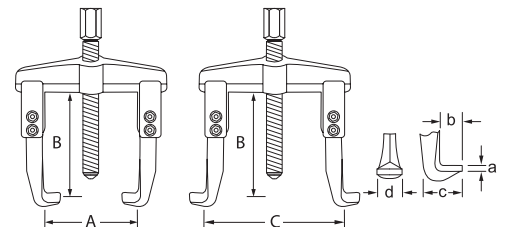

Art. Code	A mm	B mm	C mm	max. torque N-m	max. capacity t	Spindles thread x length mm	Legs					kg	1
							mm	mm	mm	mm	mm		
0726 0001	20 - 90	100	70 - 130	80	4,5	M14 x 1,5 x 130	17	3	13	25	20	1,0	1
0726 0002	25 - 130	100	80 - 180	80	4,5	M14 x 1,5 x 130	17	3	13	25	20	1,2	1
0726 0003	50 - 160	150	105 - 220	150	6,5	G 1/2" x 14Gg x 210	22	4	16	35	25	3,0	1
0726 0004	60 - 200	150	120 - 270	150	6,5	G 1/2" x 14Gg x 210	22	4	16	35	25	3,3	1
0726 0005	80 - 250	200	160 - 330	320	11	G 3/4" x 14Gg x 280	27	5	25	54	35	7,4	1
0726 0006	80 - 350	200	160 - 420	320	11	G 3/4" x 14Gg x 280	27	5	25	54	35	8,5	1

■ Universal Pullers, 2 arms, with quick-action device

- For internal and external pulling
- With quick-action device
- With slim hook for confined spaces
- Surface: Zinc plated

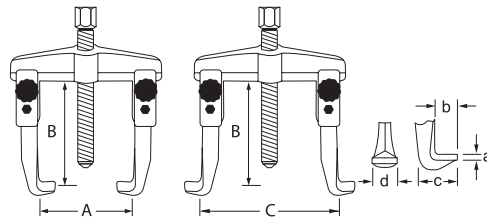

Art. Code	A mm	B mm	C mm	max. torque N-m	max. capacity t	Spindles thread x length mm	Legs				kg		
							a	b	c	d			
0726 0101	20 - 90	100	70 - 130	80	4,5	M14 x 1,5 x 130	17	3	13	25	20	1,0	1
0726 0102	25 - 130	100	80 - 180	80	4,5	M14 x 1,5 x 130	17	3	13	25	20	1,2	1
0726 0104	60 - 200	150	120 - 270	150	6,5	G 1/2" x 14Gg x 210	22	4	16	35	25	3,3	1

■ Universal Pullers, 2 arms, Krallex

- For internal and external pulling
- With extra slim „Krallex“ hooks for confined spaces
- Surface: Zinc plated

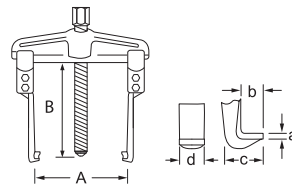

Art. Code	A mm	B mm	max. torque N-m	max. capacity t	Spindles thread x length mm	Legs				kg		
						a	b	c	d			
0726 0013	60 - 200	150	150	6,5	G1/2" x 14 Gg. x 210	22	5	8	17	40	3,3	1

■ Universal Pullers, 2 arms, Krallex, 6 legs

- 3 pullers in 1
- For internal and external pulling
- With extra slim „Krallex“ hooks for confined spaces
- 3 different heights for many applications
- Surface: Zinc plated

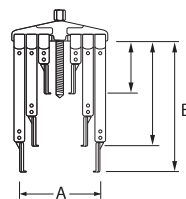

Art. Code	A mm	B mm	Legs				kg		
			a	b	c	d			
0726 0050	25 - 130	100, 200, 250	17	3,6	6	13	27	3,2	1
0726 0051	Spare hooks								
0726 0052	Spare spindle								

■ Pullers, 3 arms



- For internal pulling
- Can be used a 2-arm or 3-arm puller
- Arms in 2 lengths for different applications
- Puller legs to be used on both sides: one side with wide, the other side with narrow hooks
- Surface: Zinc plated

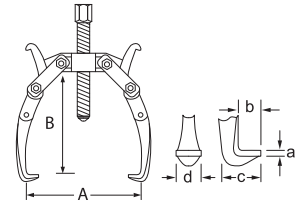

Art. Code	A mm	B mm	max. torque N-m	max. capacity t	Spindles thread x length mm	mm	mm	Legs mm	mm	mm	kg
0723 0002	20 - 150	160	80	4,0	M14 x 1,5 x 150	16	2 / 2	7 / 7	17 / 17	10 / 18	1,7

■ Pullers, 3 arms



- For internal pulling
- Heavy-duty pattern
- Interchangeable arms to be used on both sides: one side with wide, the other side with narrow hooks
- Surface: Zinc plated

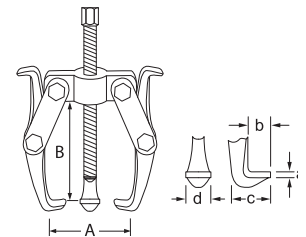

Art. Code	A mm	B mm	max. torque N-m	max. capacity t	Spindles thread x length mm	mm	mm	Legs mm	mm	mm	kg
0725 0001	20 - 150	85	60	4,0	M14 x 1,5 x 130	17	2 / 2	9 / 11	21 / 22	12 / 17	1,2
0725 0002	40 - 220	130	70	4,5	M18 x 1,5 x 240	19	4 / 4	11 / 11	25 / 27	21 / 27	2,9

■ Pullers, 3 arms, heavy duty



- For internal pulling
- Heavy-duty pattern
- High capacity
- Interchangeable arms to be used on both sides: one side with wide, the other side with narrow hooks
- Surface: Zinc plated

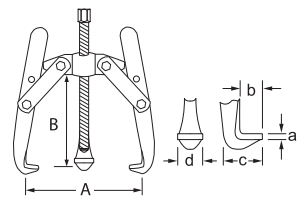

Art. Code	A mm	B mm	max. torque N-m	max. capacity t	Spindles thread x length mm	mm	mm	Legs mm	mm	mm	kg
0725 0010	50 - 300	250	220	12	G1/2" x 14Gg. x 270	22	5	25	48	30	7,3
0725 0011	50 - 400	400	220	12	G1/2" x 14Gg. x 270	22	5	25	48	30	8,8

■ Universal Pullers, 3 arms

- For internal and external pulling
- Interchangeable arms to be used on both sides: one side with wide, the other side with narrow hooks
- Adjustable height for many applications
- With slim hook for confined spaces

- Surface: Zinc plated

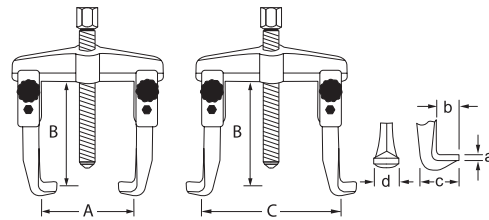

Art. Code	A mm	B mm	C mm	max. torque N·m	max. capacity t	Spindles thread x length mm	mm	mm	mm	mm	mm	kg	
0725 0021	25 - 130	100	70 - 130	80	4,5	M14 x 1,5 x 130	17	3	13	25	20	1,0	1

■ Universal Pullers, 3 arms, with quick-action device

- For internal and external pulling
- With quick-action device
- With slim hook for confined spaces
- Surface: Zinc plated

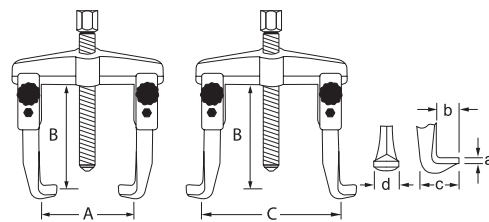

Art. Code	A mm	B mm	C mm	max. torque N·m	max. capacity t	Spindles thread x length mm	mm	mm	mm	mm	mm	kg	
0727 0101	20 - 90	100	70 - 130	80	4,5	M14 x 1,5 x 130	17	3	13	25	20	1,0	1
0727 0102	25 - 130	100	80 - 180	80	4,5	M14 x 1,5 x 130	17	3	13	25	20	1,2	1
0727 0103	50 - 160	150	105 - 220	150	6,5	G 1/2" x 14Gg x 210	22	4	16	35	25	3,0	1
0727 0104	60 - 200	150	120 - 270	150	6,5	G 1/2" x 14Gg x 210	22	4	16	35	25	3,3	1

■ Universal Pullers, 3 arms, Krallex

- For internal and external pulling
- With extra slim „Krallex“ hooks for confined spaces
- Surface: Zinc plated

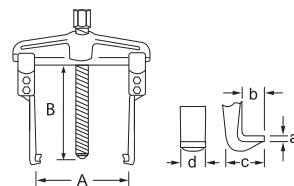

Art. Code	A mm	B mm	C mm	max. torque N·m	max. capacity t	Spindles thread x length mm	mm	mm	mm	mm	mm	kg	
0725 0031	25 - 130	100	80 - 180	80	4,5	M14 x 1,5 x 130	17	3	13	25	20	1,2	1
0725 0530		100				Hooks for 0725 0031						0,5	1

■ Battery Terminal Pullers, 2 legs



- For pulling off battery terminals, ball bearings
- Surface: Zinc plated

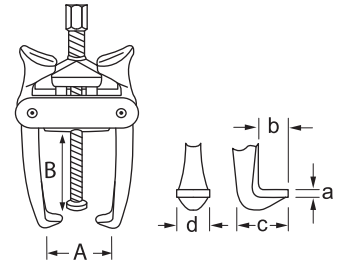

Art. Code	A mm	B mm	Spindles thread x length	Legs			g
				a	b	c	
0728 0001	10 - 50	45	84 x M8	10	2	7	190
0728 0002	10 - 70	65	105 x M10	12	2	8	300

■ Separators with Pulling Device



- For pulling off fixed parts
 - Instructions for use:
Tapered knife edges of separator fit behind bearings to be removed by tightening stud nuts
 - Turn tie rods of device into adaptor thread of separator
 - Screw in spindle of device
- Surface: Zinc plated

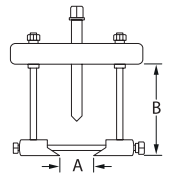

Pullers

Art. Code	A mm	B mm	for separa-tor...	adaptor thread	max. torque N-m	max. capacity t	Spindles thread x length	Zugstange mm	kg	
0727 0060	55 - 205	210	0727 0030	M16	70	4	G12" x 14Gg, x.210	22	M16 x 280	2,7

■ Ball Joint Puller



- For removal of ball pivots on tie-roads and stabilizers
- Wide clamping range due to infinite variability
- Surface: Zinc plated

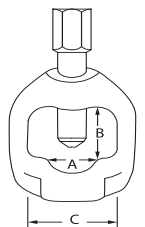

A = Jaw opening / B = max. clear height

Art. Code	A mm	B mm	C mm	max. torque N-m	Spindles thread x length	kg
0729 0001	18	40	40	50	M14 x 1,5 x 60	0,3
0729 0002	25	50	50	120	M16 x 1,5 x 60	0,7
0729 0003	29	60	60	160	M18 x 1,5 x 75	1,0
0729 0004	40	80	80	280	G 1/2" x 14Gg x 110	2,1

■ Universal Ball Joint Puller

- For passenger cars and trucks
- For removal of ball pivots on tie-rods and stabilizers
- Max. capacity up to 50 mm by reversing the bottom part
- Surface: Zinc plated

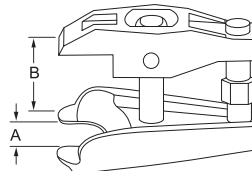

A = Jaw opening / B = max. clear height

Art. Code	A mm	B mm	max. torque N-m	max. capacity t	Pin mm	Spindles thread x length mm	pressure spindle thread x length mm	mm	kg	
0731 0001	18 - 22	max. 50	70	3,5	8	M14 x 1,5 x 48	M14 x 1,5 x 35	19	0,9	1



■ Universal Ball Joint Puller

- For passenger cars and trucks
- For removal of ball pivots on tie-rods and stabilizers
- Max. capacity up to 50 mm by reversing the bottom part
- Surface: Zinc plated

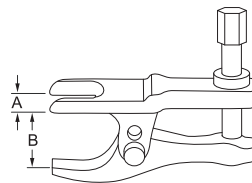

A = Jaw opening / B = max. clear height

Art. Code	A mm	B mm	max. torque N-m	max. capacity t	Spindles thread x length mm	mm	kg	
0731 0002	24	max. 50	40	3,5	M16 x 1,5 x 70	17	1,4	1



■ Universal Ball Joint Puller (trucks)

- For trucks up to 17 tons
- For removal of ball pivots on tie-rods and stabilizers
- Max. capacity up to 90 mm by reversing the bottom part
- Surface: Zinc plated

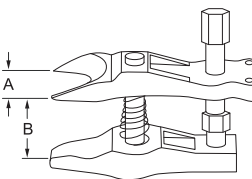

A = Jaw opening / B = max. clear height

Art. Code	A mm	B mm	max. torque N-m	max. capacity t	Spindles thread x length mm	pressure spindle thread x length mm	mm	kg	
0731 0009	36	max. 90	200	10	M18 x 1,5 x 120	G1/2" x 14Gg. x 110	22	3,7	1



■ Universal Ball Joint Puller (trucks)

- For trucks >18 tons
- For removal of ball pivots on tie-rods and stabilizers
- Max. capacity up to 115 mm by reversing the bottom part
- Surface: Zinc plated

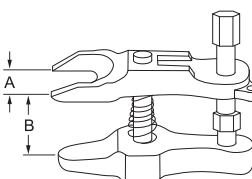

A = Jaw opening / B = max. clear height

Art. Code	A mm	B mm	max. torque N-m	max. capacity t	Spindles thread x length mm	pressure spindle thread x length mm	mm	kg	
0731 0010	45	max. 115	200	20	M24 x 1,5 x 150	G3/4" x 14Gg. x 125	27	6,4	1



Cutting soft materials. For example with the MATADOR universal knife.

For a clean cut.

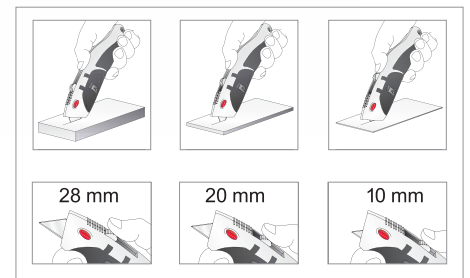

■ Universal knife PRO



- Universal knife for 18 mm blades
- Aluminum die-cast housing with non-slip grip
- Heavy duty version
- With safety blade and automatic blade feed
- Blade pushed out to 20 mm

- Includes 10 replacement blades in the magazine

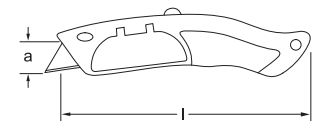

Art. Code	l mm	a mm	g	
0828 0001	170	18	200	5

■ Spare blades

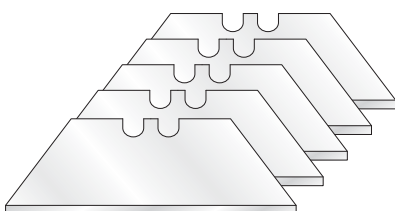

- 10 spare blades
- Chrome-alloyed steel

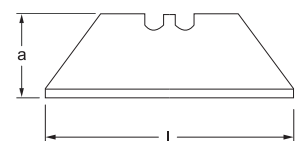

Art. Code	l mm	a mm	g	
0828 0002	62	18	20	5

■ Cable Knife with wooden handle

- The classic cable diameter for each tool assortment
- Blade folds away
- With straight, hardened blade
- With round cable scraper
- Moulded handle made out of wood
- Material: Stainless steel

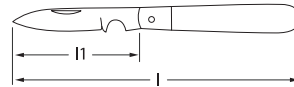

Art. Code	l mm	l1 mm	g	
0825 0001	200	90	85	10

■ Universal knife ECO

- For right handed use
- With reinforcement eyelet
- Blade 18 x 100 mm
- With 0,5 mm strong snap off blades
- Blade guide out of metal
- Housing made out of plastic

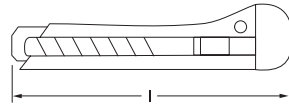

Art. Code	l mm	g	
0827 0001	140	70	5



■ Household Scissors

- For many applications
- Re-adjustable screw-joint

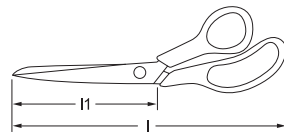

Art. Code	l mm	l1 mm	g	
0743 0001	205	65	80	6

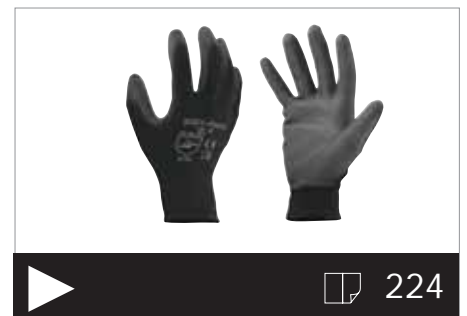
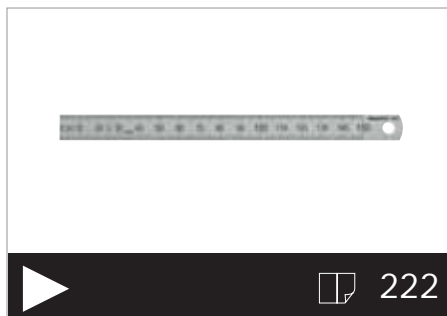
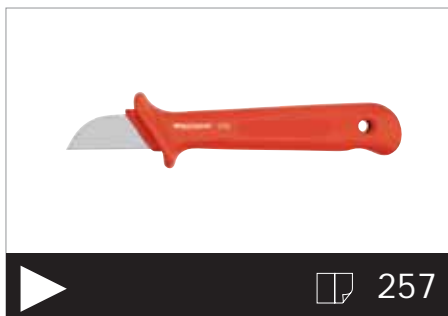

Cutting hard materials. Snips and tin snips. For a clean cut.



What does it mean: left or right cutting?

Snips are suitable to cut thin and not too tough steel plates. Hand snips are forged in one piece. However leverage snips consist of forged head and one handle made of high strength steel.

Matador's snips 745 and 747 are designed and sharpened with variable cutting edges depends on the radius:



- Left cutting snips are designed for cutting radii from right to left.
- Right cutting snips are designed for cutting radii from left to right.

■ Telephone and Cable Scissors

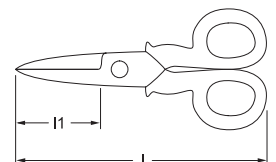

- With serrated cutting edges
- With wire cutter
- Re-adjustable screw-joint
- Straight cutting edges, polished jaw
- Made of high quality steel









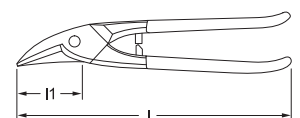

				
Art. Code	l mm	l1 mm	g	
0744 0001	140	50	115	6

■ Dulf Ideal Tin Snips



- For short, straight and figure cuts, large radius
- Cutting edges induction hardened
- Temper of cutting-edges 57 - 59° HRC
- Re-adjustable screw-joint
- Material: Tool steel, drop-forged
- Execution: Oil-hardened



								
Art. Code	mm	mm	l mm	l"	l1 mm	g		
0745 0001	R	1,5	1,0	250	9.3/4	42	540	6
0745 0002	L	1,5	1,0	250	9.3/4	42	540	6

Lever-assisted Tin Snips for optimum results. Cuts through sheet steel so easily.



■ Ideal Lever Tin Snips



- For short, straight and figure cuts with large radius
- Micro-serrated cutting edge, prevents slipping off during cutting
- Cutting edge hardness 60 - 62 HRC
- Special cutting geometry and precision cutting for a clean cut without any burrs
- With selfopening spring with lock
- With optimum leverage for easy and effortless work

- Re-adjustable screw-joint
- Ergonomically designed multi-component safety handle for better handling
- Handles made of solid rolled steel
- Made of tool steel, forged, oil-hardened

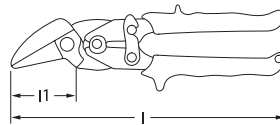

Art. Code		Fe	VA	l mm	l"	l1 mm	g	
0747 0001	R	1,8	1,2	250	9.3/4	30	515	6
0747 0002	L	1,8	1,2	250	9.3/4	30	515	6

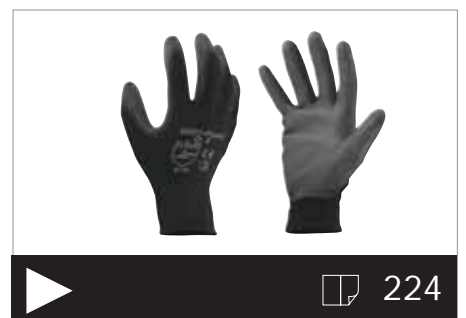
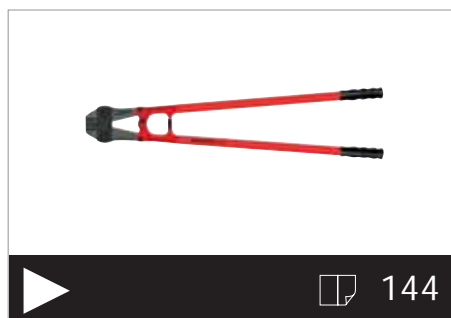

If cutting does not help: Sawing.

For an accurate, burr-free sawing.

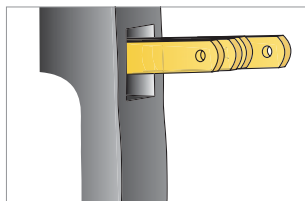

With reservoir for 7 saw blades

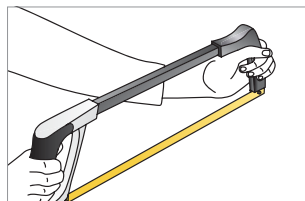

Ideal for two-hands operation

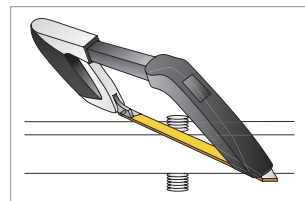

Alternative 55°-blade alignment for a flush sawing of pins etc.

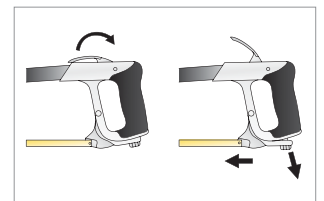

One-hand quick release mechanism



■ Hacksaw

- High blade tension of 100 kg for straight, clean cuts with precise joints.
- Lightweight aluminum frame with steel core for easy handling
- Alternative blade tension at 55 ° for flush cutting.
- In the grip integrated clamping mechanism HSS DMo5

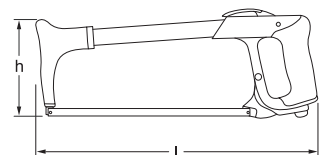

Art. Code	l mm	h mm	g	
0786 0002	440	140	750	5

High performance saw blades HSS DMo5

- From High Speed Steel with Surface special treatment (steam tempered)
- For cutting of metals and alloys to 800N/mm², dental hard
- 24 teeth per inch, for excellent cutting results
- Combines high performance with security breach
- Material: Bi-metal HSS DMo5



	Art. Code	l mm	l "	g	
0786 0003	300	12	20	10	



Hacksaw

- Stable, fixed straight blade
- Hardened stainless steel blade in oil and annealed
- Impact resistant handle with slip
- With Cap
- VDE tested according to DIN EN / IEC 60900:2004

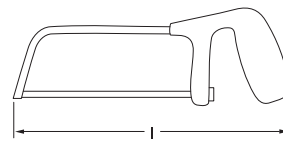

	Art. Code	l mm	g	
0787 0704	250	170	5	
0787 0003	Blade	150	12	1

Steel wire brush

- Bent type
- With wooden handle
- Wire fill
- With 5 rows, wood



	Art. Code	l mm	g	
0782 0001	290 x 40	150	5	

■ Engineers' Files



- Second cut
- Ergonomic plastic handle
- Standard: DIN 7261 A-F / ISO R 234

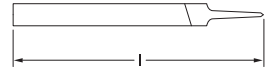

Art. Code	Execution	l mm	l "	g	
0775 0001	Flat	150	6	100	5
0775 0010	Flat	200	8	185	5
0776 0001	Flat	250	10	350	5
0775 0002	Threesquare	150	6	100	5
0775 0011	Threesquare	200	8	195	5
0776 0002	Threesquare	250	10	340	5
0775 0003	Round	150	6	70	5
0775 0012	Round	200	8	105	5
0776 0003	Round	250	10	190	5
0775 0004	Square	150	6	60	5
0775 0013	Square	200	8	125	5
0776 0004	Square	250	10	240	5
0775 0005	Halfround	150	6	80	5
0775 0014	Halfround	200	8	165	5
0776 0005	Halfround	250	10	300	5

■ Engineers' Files



- Second cut
- In plastic wallet

- Standard: DIN 7261 A-F / ISO R 234



Art. Code	Content	g	
0778 0002	5	750	1
Content	<ul style="list-style-type: none"> 0775 200 mm 0775 200 mm 0775 200 mm 0775 200 mm 0775 200 mm 		

■ Set of Warding Files

- Second cut
- In plastic wallet
- Standard: DIN 7283 A-F



Art. Code	g	
0779 0001	660	1
Content	<ul style="list-style-type: none"> 0779 150 mm 0779 150 mm 0779 150 mm 0779 150 mm 0779 150 mm 0779 150 mm 	

■ Set of Contact Files

- For spark plugs
- In plastic wallet
- Material: Special steel



Art. Code	l mm	l1 mm	a mm	h mm	g	
0780 0001	150	81	8	1	70	5

MATADOR Scraper. Extremely sharp. At the disposal of residues on smooth Surfaces.



What are scraper?

A scraper is a tool with minimum one cutting edge to scrape.

Scrapers are used to smooth metal surfaces in hundredths of a millimetre in the metal sector. The most common form is the triangular and blunt scraper.

Gasket scraper used for disposal of residues on cylinder heads, valve covers and flat scrapers.

Glass scraper consists of extreme sharp blades. They are useful to remove labels, adhesive residues on surfaces of glass without causing scratches.

■ Three-Edged Hollow Ground Scraper



- Working ends polished
- Flanged blade made of Chrome Vanadium steel
- With lacquered wooden handle
- Standard: DIN 8350 Form B
- Material: Chrome Vanadium

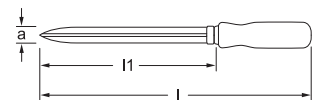

Art. Code	l mm	l "	l1 mm	l1 "	a mm	g
0788 0001	260	10	150	6	16	130
0788 0002	310	12	200	8	16	190
0788 0003	380	15	250	10	16	250

■ Curved Bearing Scraper



- Working ends polished
- Flanged blade made of Chrome Vanadium steel
- With lacquered wooden handle

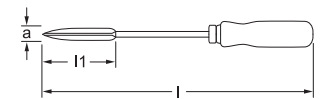

Art. Code	l mm	l "	l1 mm	l1 "	a mm	g
0789 0001	260	10	150	6	16	100
0789 0003	380	15	250	10	16	200

Flat scraper

- Working ends polished
- Flanged blade made of Chrome Vanadium steel
- With lacquered wooden handle
- Standard: DIN 8350 Form A
- Material: Chrome Vanadium

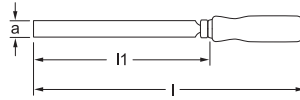

Art. Code	l mm	l" "	l1 mm	l1" "	a mm	g	
0790 0001	270	10	150	6	20	160	5
0790 0003	380	15	250	10	25	320	5

Gasket scraper

- For removal of waste on washers and gaskets
- Long type
- Working ends polished
- With impact resistant plastic handle

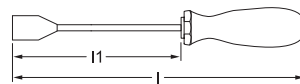

Art. Code	l mm	l" "	l1 mm	l1" "	g	
0840 0001	250	10	150	6	110	5

Multi Purpose / Glass Scraper

- Heavy-duty scraper with extremely sharp blade
- For unsticking labels, cleaning glasses and other smooth materials
- No scratches on glass
- With strong extra-wide grip to prevent sore hands
- With hanging hole
- Blade with red edge protector

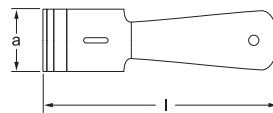
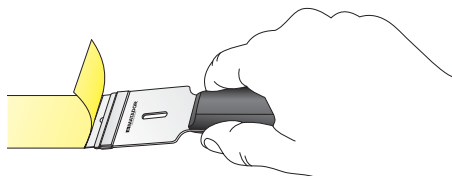

Art. Code	l mm	a mm	g	
0841 0001	120	39	30	5

- Spare blades (10 pcs)

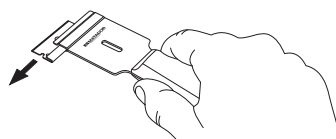

Art. Code	h mm	l mm	b mm	g	
0841 0095	0,30	39	19,33	5	1

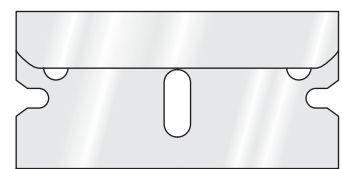

The 1x1 of the correct HSS twist drill.

HSS = High speed steel. Less it should not be.



<p>*** HSS-R</p>	<ul style="list-style-type: none"> - Roll rolled - Dark gray / black - Very flexible and durable - High breaking strength - Rather unsuitable for accurate boreholes - A cost-saving - Ideal for structural steel and steel alloys simple - Application: Normal holes with a hand drill 	<p>**** HSS-G</p>	<ul style="list-style-type: none"> - Polished - Silver Shiny - Higher precision than HSS-R with excellent concentricity - Higher risk of fracture than HSS-R - For all steels with high strength and stainless material - Application: Precision holes in stationary drills 	<p>***** HSS-E -Co 5-</p>	<ul style="list-style-type: none"> - Ground and in addition coated with cobalt (Co 5) - Rainbow-colored - Higher precision than HSS-R with excellent concentricity - Higher risk of fracture than HSS-R - For all steels with high strength and stainless material - Application: Precision holes in stationary drills
----------------------	---	-----------------------	---	-----------------------------------	--

Twist drill assortments M



- Assortment with 19 high-performance twist drills
- In a stable sheet steel case
- For alloyed and unalloyed steel up to 900 N/mm², aluminum etc.
- Right hand cutting
- From Ø 3.0 mm split point according to DIN 1412 C
- Spiral angle: 20 - 30 °
- Tolerance on Ø: h8
- Standard: DIN 338

Art. Code	g	
0762 9190	800	1
0762 Ø 1,0 – 10,0 mm x 0,5 mm increasing		

Twist drill assortments XL

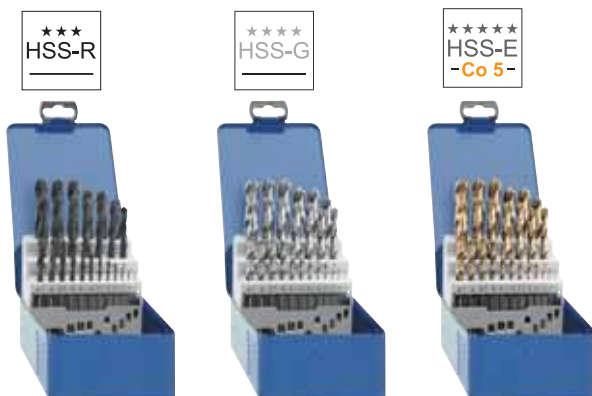

- Assortment with 25 high-performance twist drills
- In a stable sheet steel case
- For alloyed and unalloyed steel up to 900 N/mm², aluminum etc.
- Right hand cutting
- From Ø 3.0 mm split point according to DIN 1412 C
- Spiral angle: 20 - 30 °
- Tolerance on Ø: h8
- Standards: DIN 338

Art. Code	g	
0762 9251	800	1
0762 9252	800	1
0762 Ø 1,0 – 10,0 mm x 0,5 mm increasing		

Hand Taps HSS



- Universal set of hand taps M3 - M12
- With tool holder
- In a robust metal case

- Material: HSS
- Standard: DIN 352

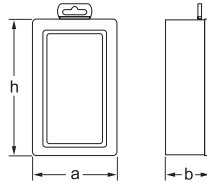

Art. Code	a mm	h mm	b mm	g	
0763 9160	110	160	35	710	1
Content	0763 2x: M3 - M4 - M5 - M6 - M8 - M10 - M12 0763 1.1/2 0772				

Hand Taps HSS



- Universal set of hand taps M3 - M12
- With core drills
- In a robust metal case

- Material: HSS
- Standard: DIN 352

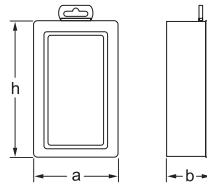

Art. Code	a mm	h mm	b mm	g	
0763 9150	110	160	35	655	1
Content	0762 M3 - M4 - M5 - M6 - M8 - M10 - M12 0762 2,5 - 3,3 - 4,2 - 5,0 - 6,8 - 8,5 - 10,2 Ø 0763 1.1/2				

Set of circular dies HSS



- Dies in front slotted (closed) execution
- Suitable for general use e.g. in steel up to 900N/mm²
- Ø-tolerances: 2A, 6g
- In robust metal case

- Material: HSS
- Standard: DIN 338

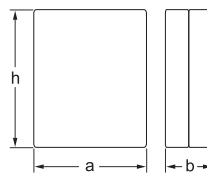

Art. Code	a mm	h mm	b mm	g	
0765 9080	80	120	30	450	1
Content	0765 M3 - M4 - M5 - M6 - M8 - M10 - M12 Ø 25 mm 0765 25 x 9				

Thread Gauges



- For metric and Whitworth threads
- For checking inside and outside radius

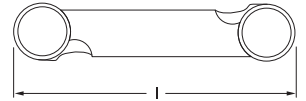

Art. Code	mm	g
0764 0001 M	0,25 - 6,00	40 10
0764 0003 M + W	0,25 - 6,00 + 4 - 62	75 10

Screw Extractor Sets



- For extracting broken screws with right-hand thread and broken-off tube ends of fittings
- Material: 59 CrMo4 hardened to 54 - 56 HRC
- With milled groove design and optimized geometry and thread length, gives rise to significant
- Surface: black finished
- Reducing the Ausdrehkräfte
- Polished shank, rolled thread
- Set in plastic box

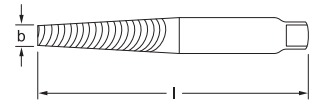

No.	1	2	3	4	5	6	7	8
	mm 1,75 0,069	2,2 0,087	3,3 0,130	4,75 0,187	6,35 0,250	9,5 0,375	12,7 0,5	19 0,75
	mm 3,6 5/32	5,0 3/16	6,5 1/4	8,8 21/64	11,0 7/16	15,0 19/32	19 3/4	25 1
	mm 50 2	57 2.3/8	64 2.11/16	71 3	78 3.3/8	85 3.3/4	95 4.1/8	100 4.3/8
	mm M 3-6 1/8-1/4	M 6-8 1/4-5/16	M 8-11 5/16-7/16	M 11-14 7/16-9/16	M 14-18 9/16-3/4	M 18-24 3/4-1	M 24-33 1-1.3/8	M 33-50 1.3/8-2
	mm 2,5 3/32	3 1/8	4,5 11/64	6 15/64	8 5/16	11 7/16	14 9/16	21 53/64

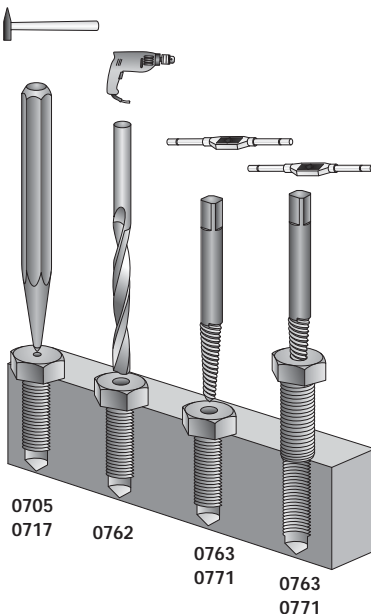

Art. Code	g
0771 0001 5	150 1
0771 0002 6	160 1
0771 0003 8	800 1

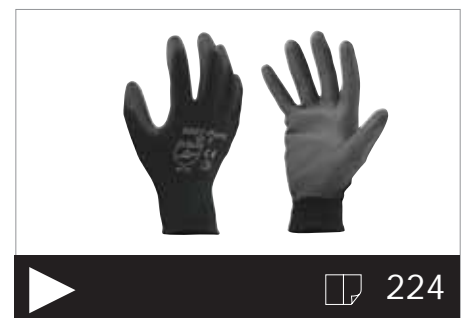
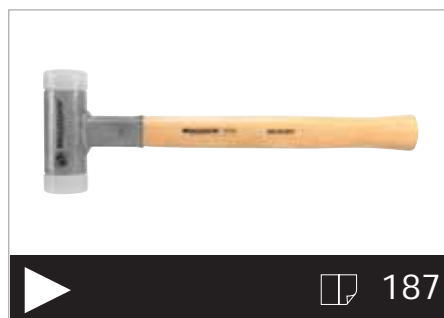

Tap wrenches

- Universal tool holder with ratchet and 2-jaw chuck
- For all tools with square or hexagonal shank (size 2)
- For taps, taps bits, bit holder with bits etc.
- With T-handle for comfortable working, adjustable and removable.
- With hardened parallel jaws, replaceable

- For Taps and Screw M5 - M12

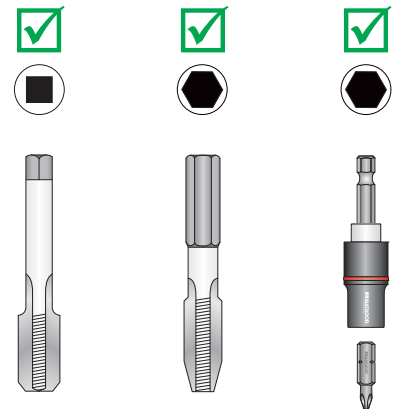
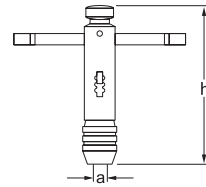

Art. Code	Clamping range mm	a mm	h mm	g	
0772 0001	2,4 - 5,5	M3 - M10	80	155	1
0772 0002	4,5 - 7,0	M5 - M12	100	330	1

Thread Restorers

- For restoring damaged inside and outside threads
- Suitable for right and left handed threads
- Two sided serviceable

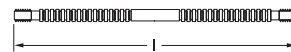

Art. Code	Thread pitch:	a mm	g		
0077 4001	0.8 / 1.0 / 1.25 / 1.5 / 1.75 / 2.0 / 2.5 / 3.0 mm	MM (ISO)	230	120	1

Screw-IT Screw Extractor

- Loosens nearly all damaged, unhardened and even rusty screws without thread repair tools
- For all threads from M2.5 - M6
- Simply drive the tip of the the MATADOR ScrewIT! into the screw head by using a hammer, then unscrew the screw



Perfect for damaged or rusted screw heads.



With impact cap for aimed release of hammer force

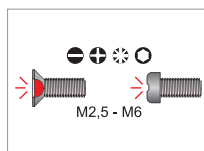

For all threads from M2.5 - M6.

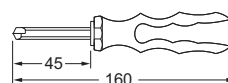

Art. Code	a mm	g	
0770 0002 M2,5 - M6	160	116	1



Screw IT!

Measuring tools.

■ Feeler Gauges



- Blades fold into metal case
- Blade length 100 mm
- 4" tapered blades
- Surface: Polished
- Material: Spring steel stripmaterial

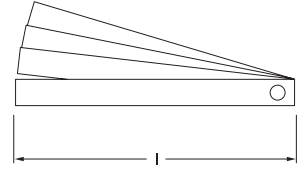

Art. Code	l mm	g		
0760 0002	13	0,05 - 1,00	70	10
0760 0003	20	0,05 - 1,00	100	10
0760 0005	13	2 - 35 / 100	50	10
0760 0006	20	2 - 40 / 100	80	10

■ Measuring Tape



- Automatic tape rewriter with return stop
- Measuring tape vaulted
- With double scale and hook for precise inside and outside measurements
- Very solid

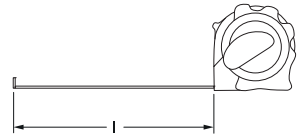

Art. Code	l m	g		
0798 0002	3	70	10	
0798 0005	5	85	10	

■ Rules, flexible



- Hardened steel
- Satin chrome finish
- Etched reading mm and 1/2 mm
- Double scale
- Material: Spring hardened steel

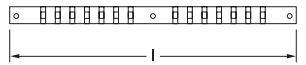

Art. Code	l mm	g		
0798 1030	300 x 15 x 0,5	20	10	

■ Rules, non flexible



- Hardened steel
- Satin chrome finish
- Etched reading mm and 1/2 mm
- Double scale
- Material: Spring hardened steel



Art. Code	l mm	g		
0798 2030	300 x 30 x 1,0	25	5	

■ Spirit Level

- With one horizontal and one vertical vial
- Solid acrylic block vials
- Accuracy of 0,5 mm/ metre = 0,028° in standard position
- Unbreakable, unadjustable, weather constant

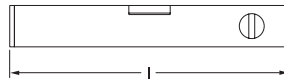

Art. Code	l mm	g	
0798 9040	400	300	1

■ Precision Vernier Caliper

- For inside, outside and depth measuring
- Display 0.05 mm - 0.008"
- Accord. to DIN 862
- Matt chrome finish
- With raised slideways
- Vernier scale extended up to 39 mm
- Jaws 40 mm
- With thumb lock
- Material: Stainless steel

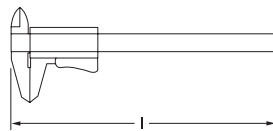

Art. Code	l mm	g	
0798 5015	150	110	1

■ Electronic Caliper

- For inside, outside, step and depth measuring (4 ways)
- Display and accuracy 0.01 mm -0.0005"
- Reversible from mm to inch
- With interface RS232C for data processing
- Accuracy according to DIN 862
- In plastic case
- Material: Stainless steel, hardened
- Surface: Matt chrome finish

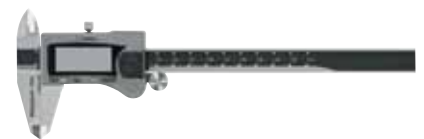
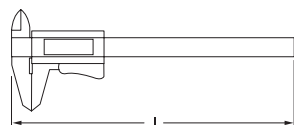

Art. Code	l mm	g	
0798 5020	150	410	1

■ Hard Metal Marking Tool



- Retractable for protection of the point and prevention of injuries
- Replaceable
- Secure hold of the point via chuck
- Shaft with clip and knurled grip area

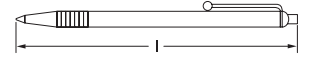

Art. Code	l mm	g	
0799 0001 Standard-Type	140	15	10

■ Scriber



- With one straight and one angled screwed-in steel point
- Handle gun metal finish and knurled



Art. Code	l mm	g	
0799 1010	250	52	10

■ Knee pads



- Knee pads in universal size
- With one belt
- Protects your knees during work



Art. Code	g	
7125 0001	50	1

■ Micro fine woven gloves



- According to CE / EN 420 / 388
- Very comfortable design and fit
- Especially breathable fabric
- With PU reinforced gripping palm
- Ideal for working with small parts
- Silicone-free, also suitable for allergy sufferer
- 12 pair / box



Art. Code		g	
7110 0001	L 8	10	1
7110 0002	XL 9	20	1
7110 0003	XXL 10	25	1

Pick-up tools.

Mini Magnetic Pick Up Tool

- Mini-Magnetic Pick Up Tool
- Flexible
- Diameter of magnet only 4 mm
- Perfect in household

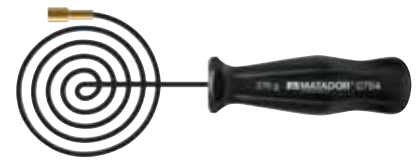
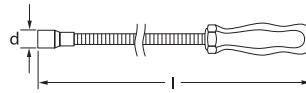

Art. Code	g	d mm	l mm	g	
0784 0004	270	4	400	22	1

Magnetic Pick Up Tools

- With Neodym-magnet
- Very high capacity
- With flexible shaft

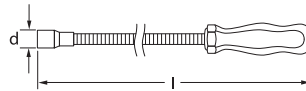

Art. Code	g	d mm	l mm	g	
0784 0005	500	8	460	60	1
0784 0001	1000	12	460	80	1
0784 0002	1800	15	520	220	1
0784 0003	3000	19	520	320	1

Gripping Tool with Claw

- With flexible shaft
- For gripping small pieces in otherwise inaccessible places
- Chrome plated

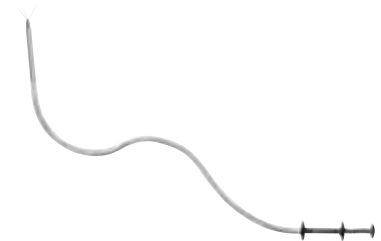
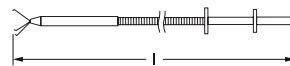

Art. Code	d mm	l mm	g	
0877 0001	7	540	115	1



Lubrication.



■ Hopper



- Made of black plastic
- With strainer
- Flexible screw off tube

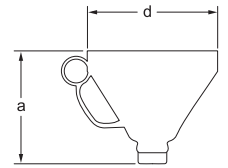

Art. Code	a mm	d mm	g	
0792 0001	120	160	150	1

■ Plastic Oiler



- With double-stroke pump
- Plastic

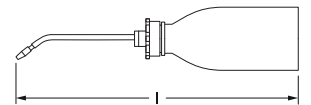

Art. Code	ccm	g	
0793 0001	300	200	5

■ Precision Oiler



- For precision oiling in tight and hard-to-reach places and machines
- Aluminium construction
- For use with lubricants only
- Generous reservoir
- Convenient pocket clip

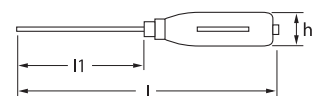

Art. Code	h mm	l mm	l1 mm	mm	g	
0793 0002	15	145	50	5 - 5/8	40	1

■ Lever Grease Gun TWIN LOCK

- With TWIN-LOCK system
- Against dummy-lubrication (!), the life-insurance for every bearing point
- Grease gun according to DIN 1283 - for 400 g cartridge or 500 g bulk grease
- Robust industrial construction
- Connecting thread M10 x 1
- Complete with 4-jaw hydraulic coupler, angled spout, flexible hose

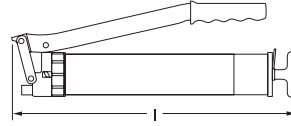

Art. Code	mm	ccm	g
0794 0005 Set		500	1700
0794 0001 Lever Grease Gun		500	1500
0794 0002 Hydraulic Coupler			80
0794 0003 Angled Spout	150		30
0794 0004 Flexible Hose	12 x 300		120

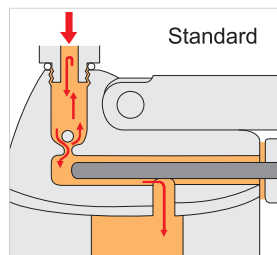

Grease Gun without TWIN-LOCK system - at high backpressure the grease flows back into the barrel (dummy-lubrication)

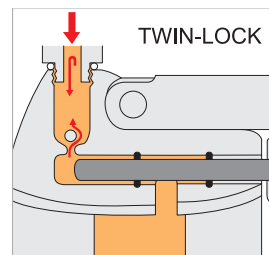

Grease Gun with TWIN-LOCK system - 2 O-rings protect the precision made piston against abrasion and prevents the flow-back of grease into the barrel



■ Talc



- Highest purity
- Lubricant for all locks, hinges, bolts, etc.
- In the car, home and in the workshop

Art. Code	ml	g
8174 0003	100	40

■ Graphite



- The perfect rubber care
- For tires, tubes, seals, cuffs, soft plastics, latex, etc.
- Sputtering and possibly rub slightly
- Protects against heat and aging-related bonding

Art. Code	ml	g
8174 0004	100	50

■ Rust remover



- Highly effective flow and lubrication oil
- Removes rust and all other fixed compounds on screws, nuts, iron railings, lattice towers etc.
- Lubricates everything effectively
- Highly effective against squeaking and creaking noises
- Effective wear protection

Art. Code	ml	g
8146 0001	500	500

■ Brake cleaner



- Cleans and degreases brakes and all other parts
- Ideal as an universal cleaner
- Evaporates without residue and dries quickly
- Cleans brake & clutch parts without dismantling, removes brake fluid, oil, dust etc. and helps maximize brake efficiency, even removes resinous deposits

Art. Code	ml	g
8146 0002	500	500

VDE Tools.

Be a MATADOR.



Content

VDE.

Page Article group



VDE-Spanners.

- 251 Universal cabinet key
- 251 Hex Keys (VDE)
- 251 T-Handles (VDE)



VDE-Ratchet and Sockets.

- 252 Reversible Ratchet (VDE)
- 252 Extension (VDE)
- 252 Sockets (VDE)
- 253 Screwdriver Bit Sockets (VDE)
- 253 Sockets Long Type (VDE)



VDE-Pliers.

- 253 Heavy Duty Combination Pliers (VDE)
- 254 Long Round Nose Pliers (VDE)
- 254 Long Flat Nose Pliers (VDE)
- 254 Side Cutters (VDE)
- 254 Wire Stripping Pliers (VDE)
- 255 Telephone Pliers, straight (VDE)
- 255 Telephone Pliers, bent (VDE)
- 255 Cable Cutter (VDE)
- 255 Pliers Assortment L (VDE)



VDE-Screwdriver.

- 256 2K-Screwdrivers, slotted (VDE)
- 256 Voltage Testers (VDE)
- 256 2K-Screwdrivers, PH (VDE)



Miscellaneous.

- 257 Hexagon Nut Spinners (VDE)
- 257 Set of screwdrivers (VDE), 6-pcs
- 257 Electrician's Scissors (VDE)
- 257 Cable Knife (VDE)
- 258 Inspection Mirror (VDE)
- 258 Universal soldering iron
- 258 Digital multimeter
- 259 Electrician's Tool Kit Automotive (VDE)
- 259 Electrician's Tool Kit in ABS case (VDE)



MATADOR VDE-Tools. Safety first.

Working on voltage.

2K Red, hard turning zone made of special plastic for quick working with low friction.

2K Yellow, soft and anti-slip grip zone made of TPE plastic for secure hold with maximum pressure.

1000 V



High security by unique identification.



International standards for more safety.

In Germany as well as in most of other countries it is the law that works on hot parts are only to be conducted under certain safety regulations and by trained specialists.

The application of especially manufactured tools belongs to that. These have to be according to the international standard IEC 60900 (identically with EN 60900 for Europe and DIN EN 60900 for Germany).

Therefore all MATADOR insulated tools have the VDE approval mark additionally to the DIN EN 60900 mark. This means additional security because every production and testing point is individually examined, certified and regularly supervised by the VDE. For your safety.

Approval process during production.

The approval processes during the running production constituted by the standards are complex and make sure that the requirements of the DIN EN 60900 standard are fulfilled without exceptions.

For example tool handles should not disengage themselves during usage or get damaged. Tools will be tested by improving their resistance of heat, cold, shock and impact.

At the end of the production process every tool has to be tested with an AC voltage of 10,000 V AC and voltage of 1.500 V DC.

100% routine test and VDE certificate.

Every model of an insulated tool is put to an acid test regarding mechanical and electrical safety, before it gets a type-approval.

The VDE approval institute withdraws in irregular intervals test samples from the running production or the current stock for intensive random inspections.

The VDE-logo proves that the manufacturer goes beyond his personal responsibility determined by the DIN EN 60900 standard and lets himself be supervised by independent specialists of the VDE-institute.

1000 V



The MATADOR Double Check coating.

All MATADOR soft-plastic insulated safety tools are equipped with the MATADOR Double Check coating.

This bi-coloured double insulation offers an additional safety factor, since the yellow alert colour under the red outer layer indicates reliably damages and wear of the insulation and therefore supports the dictated regular inspection.

Whether conventional solutions with 2-component-handles or the complex tools with a double plastic insulation – both processes fulfill the requirements of the standard.

MATADOR
Double Check

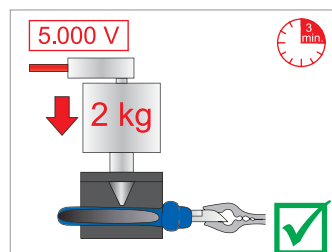
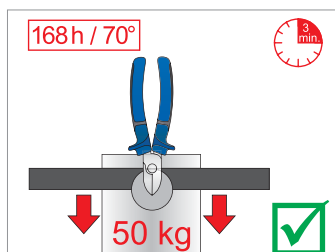
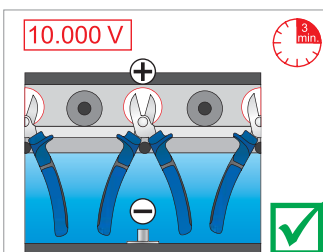

■ Universal cabinet key

- Plastic adapter with ball chain approx. 20 cm
- Bit with hexagon drive 6.3 mm (1/4")

Material: Zinc (GD-Zn)

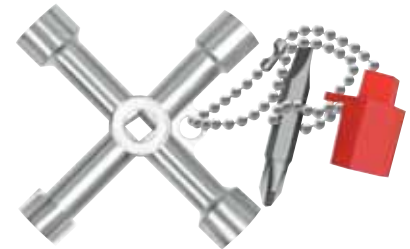

Art. Code	l mm	mm	mm	mm	mm	g		
0160 0001	70	1,0	PH 2	5 / 7 / 8	8 / 9	4 - 10	75	10

■ Hex Keys (VDE)

- For hexagon screws
- Each piece tested with 10.000 V
- Multilayer dipped insulation

Material: Chrome Vanadium
Surface: Insulated acc. to IEC 60900:2004



Art. Code	mm	l mm	g	
0448 0030	3	130	20	1
0448 0040	4	140	30	1
0448 0050	5	160	50	1
0448 0060	6	180	80	1
0448 0080	8	200	140	1
0448 0100	10	225	230	1
0448 0120	12	250	245	1



MATADOR
Double
Check

1000 V
⚡ ⚠ Ⓢ

■ T-Handles (VDE)

- For hexagon screws
- Each piece tested with 10.000 V
- Multilayer dipped insulation

Material: Chrome Vanadium
Surface: Insulated acc. to IEC 60900:2004



Art. Code	mm	g	
0449 0040	4	57	1
0449 0050	5	62	1
0449 0060	6	82	1
0449 0080	8	98	1



MATADOR
Double
Check

1000 V
⚡ ⚠ Ⓢ

■ Reversible Ratchet (VDE)

1/2 12.5 mm

- With safety lock and quick-release function
- Robust toothing with 36 teeth
- For hand-operated sockets and adapters
- With square drive as per DIN 3120 - C 12.5 / ISO 1174
- Each piece tested with 10.000 V
- Standards: DIN 3122 / ISO 3315
- Material: Chrome Vanadium
- Surface: Insulated acc. to IEC 60900:2004



1000 V

MATADOR
Double
Check

Art. Code	mm	"	l mm	g	
4161 0001	12,5	1/2	280	537	1

■ Extension (VDE)

1/2 12.5 mm

- With ball locking device
- For hand-operated sockets and adapters
- With square drive as per DIN 3120 - C 12.5 / ISO 1174
- Each piece tested with 10.000 V
- Material: Chrome Vanadium
- Surface: Insulated acc. to IEC 60900:2004



1000 V

MATADOR
Double
Check

Art. Code	mm	"	mm	"	l mm	g	
4165 0001	12,5	1/2	12,5	1/2	250	410	1
4165 0125	12,5	1/2	12,5	1/2	125	206	1

■ Sockets (VDE)

SMART DRIVE 6 1/2 12.5 mm

- For metric and inch nuts and bolts
- Each piece tested with 10.000 V
- Multilayer dipped insulation
- Material: Chrome Vanadium
- Surface: Insulated acc. to IEC 60900:2004



1000 V

MATADOR
Double
Check

Art. Code	mm	"AF	g	
4175 0080	8	5/16	62	10
4175 0090	9	11/32	62	10
4175 0100	10	3/8	62	10
4175 0110	11	7/16	62	10
4175 0120	12	15/32	62	10
4175 0130	13	1/2	63	10
4175 0140	14	9/16	64	10
4175 0160	16	5/8	72	10
4175 0170	17	11/16	83	10

■ Screwdriver Bit Sockets (VDE)

- For hexagon socket screws
- Each piece tested with 10.000 V
- Multilayer dipped insulation

- Material: Chrome Vanadium
- Surface: Insulated acc. to IEC 60900:2004



Art. Code	mm	l mm	g	
4178 0100	10	70	109	10

MATADOR
**Double
Check**

1000 V

■ Sockets long type (VDE)

- For metric and inch nuts and bolts
- Each piece tested with 10.000 V
- Multilayer dipped insulation

- Material: Chrome Vanadium
- Surface: Insulated acc. to IEC 60900:2004



Art. Code	mm	"AF	g	
4181 0100	10	3/8	103	10
4181 0110	11	7/16	104	10
4181 0120	12	15/32	113	10
4181 0130	13	1/2	117	10
4181 0140	14	9/16	125	10
4181 0150	15	19/32	126	10
4181 0160	16	5/8	127	10

Art. Code	mm	"AF	g	
4181 0170	17	11/16	148	10
4181 0180	18	23/32	180	10
4181 0190	19	3/4	189	10
4181 0200	20/21	13/16	193	10
4181 0210	21	7/8	235	10
4181 0220	22	7/8	236	10

MATADOR
**Double
Check**

1000 V

■ Heavy Duty Combination Pliers (VDE)

- For cutting hard and soft wires
- Cutting edges inductively hardened
- Gripping zones for flat and round materials
- With nail and wire holder
- Integrated ring spanner
- Power transmission with optimum leverage for

- easy and effortless work
- With ergonomically shaped 2-component sleeves
- Standards: DIN ISO 5746
- Material: Tool steel
- Surface: Insulated acc. to IEC 60900:2004



Art. Code	l mm	l"			mm	mm	mm	mm	mm	g	
0500 1165	165	6.1/2			4	3,1	2	10	15	200	6
0500 1180	180	7			5,2	3,4	2,2	12	18	255	6
0500 1205	205	8			5,9	3,8	2,5	13	20	285	6

1000 V

■ Long Round Nose Pliers (VDE)

 2K



- For gripping and bending
- Serrated inside jaws
- With long round jaws
- With ergonomically shaped 2-component sleeves

- Standards: DIN ISO 5745
- Material: Tool steel
- Surface: Insulated acc. to IEC 60900:2004

1000 V



Art. Code	I mm	I "			
0520 1160	160	6.1/4		160	6

■ Long Flat Nose Pliers (VDE)

 2K



- Serrated gripping faces
- For holding and bending work

- Standards: DIN / ISO 5745
- Material: High grade tool steel C 45
- Surface: Insulated acc. to IEC 60900:2004

1000 V



Art. Code	I mm	I "			
0525 1160	160	6.1/4		185	6

■ Side Cutters (VDE)

 2K











- For cutting hard and soft wires
- Precision cutting edge for the finest wires
- Cutting edges inductively hardened
- Cutting edge hardness approx 62 HRC
- Power transmission with optimum leverage for easy and effortless work

- With ergonomically shaped 2-component sleeves
- Standards: DIN ISO 5749
- Material: Special tool steel
- Surface: Insulated acc. to IEC 60900:2004

1000 V



Art. Code	I mm	I "							
				mm	mm	mm	mm	g	
0532 1160	160	6.1/4		6	3,5	2	11	210	6
0532 1180	180	7		7	4	2,5	13	265	6

■ Wire Stripping Pliers (VDE)

2K



- With locking adjustable screw for setting
- Spring loaded
- For wires up to 6mm Ø

- For hard and soft wire
- Material: High grade tool steel C 45
- Surface: Insulated acc. to IEC 60900:2004

1000 V



Art. Code	I mm	I "	mm				
				Ø mm	mm ²	g	
0576 1160	160	6.1/4		5	10	185	6

■ Telephone Pliers, straight (VDE)



- Long, straight flat-round jaws
 - With cutting edges and burner hole
 - Serrated gripping faces
 - For hard and soft wire
- Standards: DIN / ISO 5745
 - Material: High grade tool steel C 45
 - Surface: Insulated acc. to IEC 60900:2004

Art. Code	l mm	l"	mm		mm	mm	mm	mm	g	
0585 1170	170	6.3/4			2,5	1,6		15	170	6
0585 1205	205	8			3,9	3,2	2,2	18	215	6



1000 V

■ Telephone Pliers, bent (VDE)



- Long, 45° angled, flat-round jaws
 - With cutting edges and burner hole
 - Serrated gripping faces
 - For hard and soft wire
- Standards: DIN / ISO 5745
 - Material: High grade tool steel C 45
 - Surface: Insulated acc. to IEC 60900:2004

Art. Code	l mm	l"	mm		mm	mm	mm	mm	g	
0586 1205	205	8			3,9	3,2	2,2	18	215	6



1000 V

■ Cable Cutter (VDE)



- For stripping and cutting of copper and aluminium cables without any burr and up to Ø 16 mm (50 mm²)
 - Re-adjustable screw-joint
- Material: High grade tool steel C 45
 - Surface: Insulated acc. to IEC 60900:2004

Art. Code	l mm	l"		Ø mm	mm ²	g	
0829 1160	160	6.1/4		16	50	225	6



1000 V

■ Pliers Assortment L (VDE)



- Pliers Assortment, in practical, transparent polypropylene box: robust packaging, stackable and easy to stock

Art. Code	g
0501 1301	735
<ul style="list-style-type: none"> 0500 180 mm 0532 180 mm 0585 205 mm 	1
0501 1302	735
<ul style="list-style-type: none"> 0500 180 mm 0532 180 mm 0586 205 mm 	1



1000 V

2K-Screwdrivers, slotted (VDE)

2K



1000 V

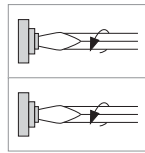

- Quality blades made of high-alloy, hardened special steel
- Blades with black finish with directly sprayed-conical blade insulation
- 2-component hole issue Signal-colour: red-yellow
- With hanging hole

- Material: Molybdän-Vanadium / Chrome Silizium-Vanadium / Chrome Vanadium
- Surface: Insulated acc. to IEC 60900:2004

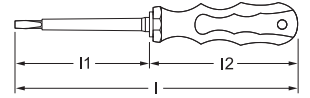

Art. Code	mm	mm	l1 mm	l2 mm	l mm	g	
0616 0425	0,4	2,5	75	85	160	40	10
0616 0635	0,6	3,5	100	95	195	47	10
0616 0840	0,8	4	100	105	205	63	10
0616 1055	1,0	5,5	125	105	230	96	10
0616 1265	1,2	6,5	150	120	270	119	10
0616 1280	1,2	8	175	120	295	182	5
0616 1610	1,6	10	200	120	320	248	5

Voltage Testers (VDE)



- Up to 230 V
- With metal clip
- Transparent handle

- Standards: VDE 0680
- Material blade: High grade tool steel
- Surface blade: Nickel plated and insulated

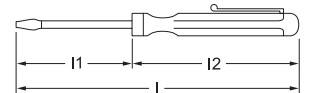

Art. Code	mm	mm	l1 mm	l2 mm	l mm	g	
0635 0635	0,6	3,5	100	95	195	40	10

2K-Screwdrivers, PH (VDE)

2K



1000 V

- Classical workshop Screwdrivers, for cross slot screws Phillips-Recess
- With 2-component handle with hard quick turning and soft power zone
- With hanging hole

- Standards: DIN ISO 8764 / tip DIN ISO 8764-1 PH
- Material blade: Chrome Vanadium black tip
- Surface: Insulated acc. to IEC 60900:2004

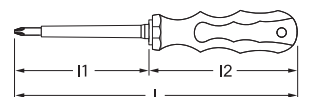

Art. Code		mm	l1 mm	l2 mm	l mm	g	
0656 0000	PH 0	5	60	90	150	43	10
0656 0010	PH 1	5	80	100	180	68	10
0656 0020	PH 2	6	100	110	210	98	10
0656 0030	PH 3	8	150	120	270	167	10

Hexagon Nut Spinners (VDE)

- Ergonomically handle for easy working and maximum torque transmission
- Insulated according to IEC 60900:2004
- Each piece tested with 10.000 V

- Standards: DIN / ISO 7445

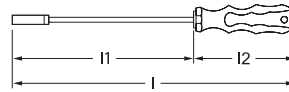

Art. Code	mm	l1 mm	l2 mm	l mm	g	
0670 1050	5	110	100	210	58	12
0670 1060	6	110	100	210	66	12
0670 1070	7	115	110	225	94	12
0670 1080	8	115	110	225	96	6
0670 1090	9	115	110	225	98	6
0670 1100	10	115	110	225	104	6
0670 1110	11	115	120	235	150	6
0670 1120	12	115	120	235	160	6
0670 1130	13	115	120	235	165	6
0670 1140	14	115	120	235	165	6
0670 1150	15	115	120	235	170	6
0670 1160	16	115	120	235	170	6
0670 1170	17	115	120	235	175	6



1000 V
⚡ ⚠ ⚡

Set of screwdrivers (VDE), 6-pcs

- VDE-Screwdriver assortment in display box
- With dual compound handles
- Insulated according to IEC 60900:2004

Art. Code	g	
0681 1001	735	1
0616	2.5 x 75 - 3.5 x 100 - 5.5 x 125 mm	
0635	0,5 x 3,0 mm	
0656	PH 1 - PH 2	



2K ⚡ ⚠ ⚡

1000 V
⚡ ⚠ ⚡

Electrician's Scissors (VDE)

- Microserrated blade
- Material: Stainless steel, ahardness 60 HRC

Art. Code	mm	g
0744 1001	140	90



1000 V
⚡ ⚠ ⚡

Cable Knife (VDE)

- With straight, hardened blade
- Blade made from stainless steel
- Each piece tested with 10.000 V
- Surface: Insulated acc. to IEC 60900:2004

Art. Code	l mm	l1 mm	g
0826 0001	180	65	65



1000 V
⚡ ⚠ ⚡

■ Inspection Mirror (VDE)



1000 V



MATADOR



- Magnified
- Each piece tested with 10.000 V
- Multilayer dipped insulation

- Surface: Insulated acc. to IEC 60900:2004

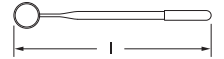

Art. Code	mm	g	
0876 1001	170	32	10

■ Universal soldering iron



1000 V



- Tried and tested universal soldering iron with 40 W for increased heat demand
- Versatile for soldering tasks in the areas of trade / service and Hobby
- Equipped with professional long-life tip

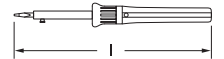

Art. Code		g	
0879 0001		400	1
0879 0090	Solder		1

■ Digital-Multimeter



- The digital multimeter for simple measurements in the automotive sector
- Entry-level model with excellent equipment features
- Power supply by 9 V block battery
- With test cable and detailed operating instructions

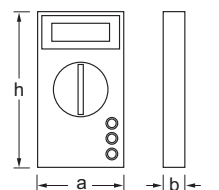

Art. Code		g	
0881 0001		300	1

Electrician's Tool Kit Automotive (VDE)

51

- Tool kit for hybrid- and electric vehicle repair with 50 high quality tools, e.g.:
- Single ended spanners 8 - 24 mm
- Adjustable Wrenches
- 3-pc. set of pliers VDE with telephone pliers, combination pliers and side cutter
- 6-pc. set of screwdrivers VDE
- 12,5(1/2) Socket Set VDE with sockets 8-22 mm
- Hex Keys with T-Handle VDE
- In practical ABS hardshell case with extra storage space
- Optional with torque wrench VDE 20-100 N·m

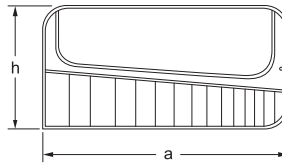

Art. Code	h mm	a mm	g
8110 9550			1
8110 9551			1
Inhalt			
0131 8 - 24 mm	0591 250 mm	0500 180 mm	4161 Reversible ratchet
0532 160 mm	0585 180 mm	0616 0,4 - 0,8 - 1,0 mm	4165 125, 250 mm
0656 PH 0 - PH 1 - PH 2	0449 4, 5, 6, 8 mm	4178 10 x 70 mm	4175 8 - 9 mm
	6179 20 - 100 N·m		4181 10 - 22 mm



1000 V

Electrician's Tool Kit in ABS case (VDE)

30

- 30 pcs. tool assortment for working on electrical systems
- In solid tool case made of strong and resistant ABS material with removable tool panels in lid and bottom



Art. Code	h mm	a mm	b mm	g
8130 0001	345	455	160	5700
8130 9531				7800
Inhalt				
0131 10 - 13 - 14 - 17 - 19 - 22 mm	0616 0,4 x 2,5 x 75 - 0,8 x 4,0 x 100 - 1,2 x 6,5 x 150 mm	0635 0,5 x 3,0 mm	0744	0826
0500 180 mm	0576 160 mm	0559 190 mm	4161	4165
0532 160 mm	0585 180 mm	4175 10 - 11 - 12 - 13 - 14 - 17 - 19 - 22 - 24 mm		



Variable inserts for further separation



3-digit combination lock



Two lockable clip locks

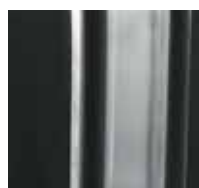

Circumferential robust aluminium frame with shock edge protection



1000 V

VDE Tools.

Be a MATADOR.



Content

VDE.

Page Article group



VDE-Spanners.

- 269 Universal cabinet key
- 269 Hex Keys (VDE)
- 269 T-Handles (VDE)



VDE-Ratchet and Sockets.

- 270 Reversible Ratchet (VDE)
- 270 Extension (VDE)
- 270 Sockets (VDE)
- 271 Screwdriver Bit Sockets (VDE)
- 271 Sockets Long Type (VDE)



VDE-Pliers.

- 271 Heavy Duty Combination Pliers (VDE)
- 272 Long Round Nose Pliers (VDE)
- 272 Long Flat Nose Pliers (VDE)
- 272 Side Cutters (VDE)
- 272 Wire Stripping Pliers (VDE)
- 273 Telephone Pliers, straight (VDE)
- 273 Telephone Pliers, bent (VDE)
- 273 Cable Cutter (VDE)
- 273 Pliers Assortment L (VDE)



VDE-Screwdriver.

- 274 2K-Screwdrivers, slotted (VDE)
- 274 Voltage Testers (VDE)
- 274 2K-Screwdrivers, PH (VDE)



Miscellaneous.

- 275 Hexagon Nut Spinners (VDE)
- 275 Set of screwdrivers (VDE), 6-pcs
- 275 Electrician's Scissors (VDE)
- 275 Cable Knife (VDE)
- 276 Inspection Mirror (VDE)
- 276 Universal soldering iron
- 276 Digital multimeter
- 277 Electrician's Tool Kit Automotive (VDE)
- 277 Electrician's Tool Kit in ABS case (VDE)



MATADOR VDE-Tools. Safety first.

Working on voltage.

2K Red, hard turning zone made of special plastic for quick working with low friction.

2K Yellow, soft and anti-slip grip zone made of TPE plastic for secure hold with maximum pressure.

1000 V



High security by unique identification.



International standards for more safety.

In Germany as well as in most of other countries it is the law that works on hot parts are only to be conducted under certain safety regulations and by trained specialists.

The application of especially manufactured tools belongs to that. These have to be according to the international standard IEC 60900 (identically with EN 60900 for Europe and DIN EN 60900 for Germany).

Therefore all MATADOR insulated tools have the VDE approval mark additionally to the DIN EN 60900 mark. This means additional security because every production and testing point is individually examined, certified and regularly supervised by the VDE. For your safety.

Approval process during production.

The approval processes during the running production constituted by the standards are complex and make sure that the requirements of the DIN EN 60900 standard are fulfilled without exceptions.

For example tool handles should not disengage themselves during usage or get damaged. Tools will be tested by improving their resistance of heat, cold, shock and impact.

At the end of the production process every tool has to be tested with an AC voltage of 10,000 V AC and voltage of 1.500 V DC.

100% routine test and VDE certificate.

Every model of an insulated tool is put to an acid test regarding mechanical and electrical safety, before it gets a type-approval.

The VDE approval institute withdraws in irregular intervals test samples from the running production or the current stock for intensive random inspections.

The VDE-logo proves that the manufacturer goes beyond his personal responsibility determined by the DIN EN 60900 standard and lets himself and his products be supervised by independent specialists of the VDE-institute.

The MATADOR Double Check coating.

All MATADOR soft-plastic insulated safety tools are equipped with the MATADOR Double Check coating.

This bi-coloured double insulation offers an additional safety factor, since the yellow alert colour under the red outer layer indicates reliably damages and wear of the insulation and therefore supports the dictated regular inspection.

Whether conventional solutions with 2-component-handles or the complex tools with a double plastic insulation – both processes fulfill the requirements of the standard.

1000 V

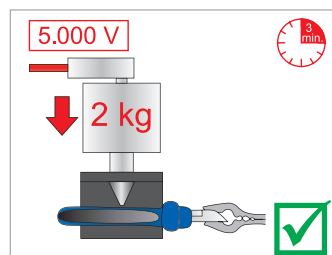
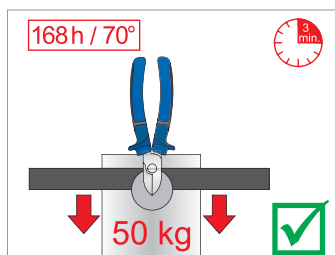
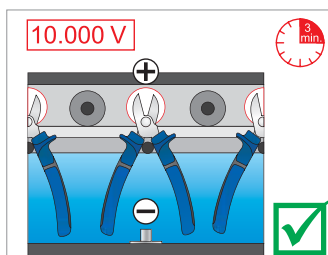

■ Universal cabinet key

- Plastic adapter with ball chain approx. 20 cm
- Bit with hexagon drive 6.3 mm (1/4")

Material: Zinc (GD-Zn)

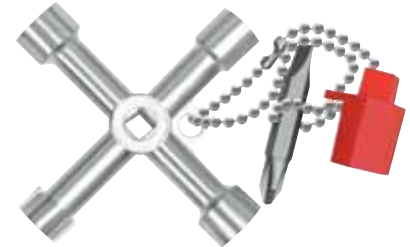

Art. Code	l mm	mm	mm	mm	mm	g		
0160 0001	70	1,0	PH 2	5 / 7 / 8	8 / 9	4 - 10	75	10

■ Hex Keys (VDE)

- For hexagon screws
- Each piece tested with 10.000 V
- Multilayer dipped insulation

Material: Chrome Vanadium
Surface: Insulated acc. to IEC 60900:2004



Art. Code	mm	l mm	g	
0448 0030	3	130	20	1
0448 0040	4	140	30	1
0448 0050	5	160	50	1
0448 0060	6	180	80	1
0448 0080	8	200	140	1
0448 0100	10	225	230	1
0448 0120	12	250	245	1



MATADOR
Double
Check

1000 V
⚡ ⚠ Ⓢ

■ T-Handles (VDE)

- For hexagon screws
- Each piece tested with 10.000 V
- Multilayer dipped insulation

Material: Chrome Vanadium
Surface: Insulated acc. to IEC 60900:2004



Art. Code	mm	g	
0449 0040	4	57	1
0449 0050	5	62	1
0449 0060	6	82	1
0449 0080	8	98	1



MATADOR
Double
Check

1000 V
⚡ ⚠ Ⓢ

■ Reversible Ratchet (VDE)

1/2 12.5 mm



- With safety lock and quick-release function
- Robust toothing with 36 teeth
- For hand-operated sockets and adapters
- With square drive as per DIN 3120 - C 12.5 / ISO 1174
- Each piece tested with 10.000 V
- Standards: DIN 3122 / ISO 3315
- Material: Chrome Vanadium
- Surface: Insulated acc. to IEC 60900:2004

1000 V

MATADOR
Double
Check

Art. Code	mm	"	l mm	g	
4161 0001	12,5	1/2	280	537	1

■ Extension (VDE)

1/2 12.5 mm



- With ball locking device
- For hand-operated sockets and adapters
- With square drive as per DIN 3120 - C 12.5 / ISO 1174
- Each piece tested with 10.000 V
- Material: Chrome Vanadium
- Surface: Insulated acc. to IEC 60900:2004

1000 V

MATADOR
Double
Check

Art. Code	mm	"	mm	"	l mm	g	
4165 0001	12,5	1/2	12,5	1/2	250	410	1
4165 0125	12,5	1/2	12,5	1/2	125	206	1

■ Sockets (VDE)

SMART DRIVE 6 1/2 12.5 mm



- For metric and inch nuts and bolts
- Each piece tested with 10.000 V
- Multilayer dipped insulation
- Material: Chrome Vanadium
- Surface: Insulated acc. to IEC 60900:2004

1000 V

MATADOR
Double
Check

Art. Code	mm	"AF	g	
4175 0080	8	5/16	62	10
4175 0090	9	11/32	62	10
4175 0100	10	3/8	62	10
4175 0110	11	7/16	62	10
4175 0120	12	15/32	62	10
4175 0130	13	1/2	63	10
4175 0140	14	9/16	64	10
4175 0160	16	5/8	72	10
4175 0170	17	11/16	83	10

■ Screwdriver Bit Sockets (VDE)

- For hexagon socket screws
- Each piece tested with 10.000 V
- Multilayer dipped insulation

- Material: Chrome Vanadium
- Surface: Insulated acc. to IEC 60900:2004



Art. Code	mm	l mm	g	
4178 0100	10	70	109	10

MATADOR
Double
Check

1000 V
⚡ ⚠ Ⓢ

■ Sockets long type (VDE)

- For metric and inch nuts and bolts
- Each piece tested with 10.000 V
- Multilayer dipped insulation

- Material: Chrome Vanadium
- Surface: Insulated acc. to IEC 60900:2004



Art. Code	mm	"AF	g	
4181 0100	10	3/8	103	10
4181 0110	11	7/16	104	10
4181 0120	12	15/32	113	10
4181 0130	13	1/2	117	10
4181 0140	14	9/16	125	10
4181 0150	15	19/32	126	10
4181 0160	16	5/8	127	10

Art. Code	mm	"AF	g	
4181 0170	17	11/16	148	10
4181 0180	18	23/32	180	10
4181 0190	19	3/4	189	10
4181 0200	20/21	13/16	193	10
4181 0210	21	7/8	235	10
4181 0220	22	7/8	236	10

MATADOR
Double
Check

1000 V
⚡ ⚠ Ⓢ

■ Heavy Duty Combination Pliers (VDE)

- For cutting hard and soft wires
- Cutting edges inductively hardened
- Gripping zones for flat and round materials
- With nail and wire holder
- Integrated ring spanner
- Power transmission with optimum leverage for

- easy and effortless work
- With ergonomically shaped 2-component sleeves
- Standards: DIN ISO 5746
- Material: Tool steel
- Surface: Insulated acc. to IEC 60900:2004



Art. Code	l mm	l"			mm	mm	mm	mm	mm	g	
0500 1165	165	6.1/2	□	⚡	4	3,1	2	10	15	200	6
0500 1180	180	7	□	⚡	5,2	3,4	2,2	12	18	255	6
0500 1205	205	8	□	⚡	5,9	3,8	2,5	13	20	285	6

1000 V
⚡ ⚠ Ⓢ

■ Long Round Nose Pliers (VDE)

 2K



- For gripping and bending
- Serrated inside jaws
- With long round jaws
- With ergonomically shaped 2-component sleeves

- Standards: DIN ISO 5745
- Material: Tool steel
- Surface: Insulated acc. to IEC 60900:2004

1000 V



Art. Code	I mm	I "			
0520 1160	160	6.1/4		160	6

■ Long Flat Nose Pliers (VDE)

 2K



- Serrated gripping faces
- For holding and bending work

- Standards: DIN / ISO 5745
- Material: High grade tool steel C 45
- Surface: Insulated acc. to IEC 60900:2004

1000 V



Art. Code	I mm	I "			
0525 1160	160	6.1/4		185	6

■ Side Cutters (VDE)

 2K











- For cutting hard and soft wires
- Precision cutting edge for the finest wires
- Cutting edges inductively hardened
- Cutting edge hardness approx 62 HRC
- Power transmission with optimum leverage for easy and effortless work

- With ergonomically shaped 2-component sleeves
- Standards: DIN ISO 5749
- Material: Special tool steel
- Surface: Insulated acc. to IEC 60900:2004

1000 V



Art. Code	I mm	I "							
				mm	mm	mm	mm	g	
0532 1160	160	6.1/4		6	3,5	2	11	210	6
0532 1180	180	7		7	4	2,5	13	265	6

■ Wire Stripping Pliers (VDE)

2K



- With locking adjustable screw for setting
- Spring loaded
- For wires up to 6mm Ø

- For hard and soft wire
- Material: High grade tool steel C 45
- Surface: Insulated acc. to IEC 60900:2004

1000 V



Art. Code	I mm	I "				
			mm	Ø mm	mm ²	g
0576 1160	160	6.1/4		5	10	185

■ Telephone Pliers, straight (VDE)



- Long, straight flat-round jaws
- With cutting edges and burner hole
- Serrated gripping faces
- For hard and soft wire
- Standards: DIN / ISO 5745
- Material: High grade tool steel C 45
- Surface: Insulated acc. to IEC 60900:2004

Art. Code	l mm	l"	mm		mm	mm	mm	mm	g
0585 1170	170	6.3/4			2,5	1,6		15	170
0585 1205	205	8			3,9	3,2	2,2	18	215



1000 V

■ Telephone Pliers, bent (VDE)



- Long, 45° angled, flat-round jaws
- With cutting edges and burner hole
- Serrated gripping faces
- For hard and soft wire
- Standards: DIN / ISO 5745
- Material: High grade tool steel C 45
- Surface: Insulated acc. to IEC 60900:2004

Art. Code	l mm	l"	mm		mm	mm	mm	mm	g
0586 1205	205	8			3,9	3,2	2,2	18	215



1000 V

■ Cable Cutter (VDE)



- For stripping and cutting of copper and aluminium cables without any burr and up to Ø 16 mm (50 mm²)
- Re-adjustable screw-joint
- Material: High grade tool steel C 45
- Surface: Insulated acc. to IEC 60900:2004

Art. Code	l mm	l"		Ø mm	mm ²	g
0829 1160	160	6.1/4		16	50	225



1000 V

■ Pliers Assortment L (VDE)



- Pliers Assortment, in practical, transparent polypropylene box: robust packaging, stackable and easy to stock

Art. Code	g
0501 1301	735
<ul style="list-style-type: none"> 0500 180 mm 0532 180 mm 0585 205 mm 	1
0501 1302	735
<ul style="list-style-type: none"> 0500 180 mm 0532 180 mm 0586 205 mm 	1



1000 V

■ 2K-Screwdrivers, slotted (VDE)

2K



1000 V

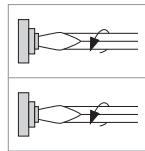

- Quality blades made of high-alloy, hardened special steel
- Blades with black finish with directly sprayed-conical blade insulation
- 2-component hole issue Signal-colour: red-yellow
- With hanging hole

- Material: Molybdän-Vanadium / Chrome Silizium-Vanadium / Chrome Vanadium
- Surface: Insulated acc. to IEC 60900:2004

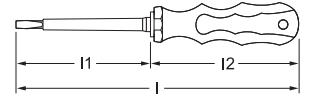

Art. Code	mm	mm	l1 mm	l2 mm	l mm	g	
0616 0425	0,4	2,5	75	85	160	40	10
0616 0635	0,6	3,5	100	95	195	47	10
0616 0840	0,8	4	100	105	205	63	10
0616 1055	1,0	5,5	125	105	230	96	10
0616 1265	1,2	6,5	150	120	270	119	10
0616 1280	1,2	8	175	120	295	182	5
0616 1610	1,6	10	200	120	320	248	5

■ Voltage Testers (VDE)



- Up to 230 V
- With metal clip
- Transparent handle

- Standards: VDE 0680
- Material blade: High grade tool steel
- Surface blade: Nickel plated and insulated

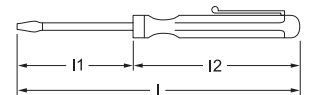

Art. Code	mm	mm	l1 mm	l2 mm	l mm	g	
0635 0635	0,6	3,5	100	95	195	40	10

■ 2K-Screwdrivers, PH (VDE)

2K



1000 V

- Classical workshop Screwdrivers, for cross slot screws Phillips-Recess
- With 2-component handle with hard quick turning and soft power zone
- With hanging hole

- Standards: DIN ISO 8764 / tip DIN ISO 8764-1 PH
- Material blade: Chrome Vanadium black tip
- Surface: Insulated acc. to IEC 60900:2004

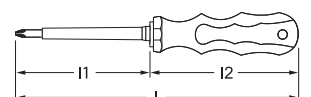

Art. Code		mm	l1 mm	l2 mm	l mm	g	
0656 0000	PH 0	5	60	90	150	43	10
0656 0010	PH 1	5	80	100	180	68	10
0656 0020	PH 2	6	100	110	210	98	10
0656 0030	PH 3	8	150	120	270	167	10

Hexagon Nut Spinners (VDE)

- Ergonomically handle for easy working and maximum torque transmission
- Insulated according to IEC 60900:2004
- Each piece tested with 10.000 V

- Standards: DIN / ISO 7445

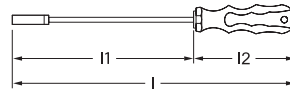

Art. Code	mm	l1 mm	l2 mm	l mm	g
0670 1050	5	110	100	210	58
0670 1060	6	110	100	210	66
0670 1070	7	115	110	225	94
0670 1080	8	115	110	225	96
0670 1090	9	115	110	225	98
0670 1100	10	115	110	225	104
0670 1110	11	115	120	235	150
0670 1120	12	115	120	235	160
0670 1130	13	115	120	235	165
0670 1140	14	115	120	235	165
0670 1150	15	115	120	235	170
0670 1160	16	115	120	235	170
0670 1170	17	115	120	235	175



1000 V
⚡ ⚠ ⚡

Set of screwdrivers (VDE), 6-pcs

- VDE-Screwdriver assortment in display box
- With dual compound handles
- Insulated according to IEC 60900:2004

Art. Code	g
0681 1001	735

0616 2.5 x 75 - 3.5 x 100 - 5.5 x 125 mm
 0635 0.5 x 3,0 mm
 0656 PH 1 - PH 2



2K ⚡ ⚠ ⚡

1000 V
⚡ ⚠ ⚡

Electrician's Scissors (VDE)

- Microserrated blade
- Material: Stainless steel, hardness 60 HRC

Art. Code	mm	g
0744 1001	140	90



1000 V
⚡ ⚠ ⚡

Cable Knife (VDE)

- With straight, hardened blade
 - Blade made from stainless steel
 - Each piece tested with 10.000 V
- Surface: Insulated acc. to IEC 60900:2004

Art. Code	l mm	l1 mm	g
0826 0001	180	65	65



1000 V
⚡ ⚠ ⚡

■ Inspection Mirror (VDE)



1000 V



MATADOR



- Magnified
- Each piece tested with 10.000 V
- Multilayer dipped insulation

- Surface: Insulated acc. to IEC 60900:2004

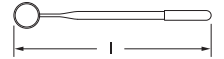

Art. Code	mm	g	
0876 1001	170	32	10

■ Universal soldering iron



1000 V



- Tried and tested universal soldering iron with 40 W for increased heat demand
- Versatile for soldering tasks in the areas of trade / service and Hobby
- Equipped with professional long-life tip

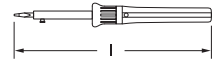

Art. Code		g	
0879 0001		400	1
0879 0090	Solder		1

■ Digital-Multimeter



- The digital multimeter for simple measurements in the automotive sector
- Entry-level model with excellent equipment features
- Power supply by 9 V block battery
- With test cable and detailed operating instructions

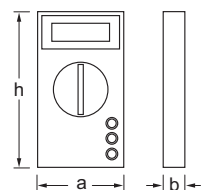

Art. Code		g	
0881 0001		300	1

Electrician's Tool Kit Automotive (VDE)

51

- Tool kit for hybrid- and electric vehicle repair with 50 high quality tools, e.g.:
- Single ended spanners 8 - 24 mm
- Adjustable Wrenches
- 3-pc. set of pliers VDE with telephone pliers, combination pliers and side cutter
- 6-pc. set of screwdrivers VDE
- 12,5(1/2) Socket Set VDE with sockets 8-22 mm
- Hex Keys with T-Handle VDE
- In practical ABS hardshell case with extra storage space
- Optional with torque wrench VDE 20-100 N·m

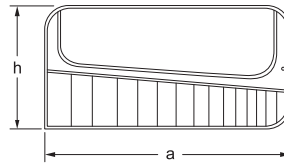

Art. Code	h mm	a mm	g
8110 9550			1
8110 9551			1
Inhalt			
0131 8 - 24 mm	0591 250 mm	0500 180 mm	4161 Reversible ratchet
0532 160 mm	0585 180 mm	0616 0,4 - 0,8 - 1,0 mm	4165 125, 250 mm
0656 PH 0 - PH 1 - PH 2	0449 4, 5, 6, 8 mm	4178 10 x 70 mm	4175 8 - 9 mm
	6179 20 - 100 N·m		4181 10 - 22 mm



1000 V

Electrician's Tool Kit in ABS case (VDE)

30

- 30 pcs. tool assortment for working on electrical systems
- In solid tool case made of strong and resistant ABS material with removable tool panels in lid and bottom



Art. Code	h mm	a mm	b mm	g
8130 0001	345	455	160	5700
8130 9531				7800
Inhalt				
0131 10 - 13 - 14 - 17 - 19 - 22 mm	0616 0,4 x 2,5 x 75 - 0,8 x 4,0 x 100 - 1,2 x 6,5 x 150 mm	0635 0,5 x 3,0 mm	0744	0826
0500 180 mm	0576 160 mm	0559 190 mm	4161	4165
0532 160 mm	0585 180 mm	4175 10 - 11 - 12 - 13 - 14 - 17 - 19 - 22 - 24 mm		



Variable inserts for further separation



3-digit combination lock



Two lockable clip locks

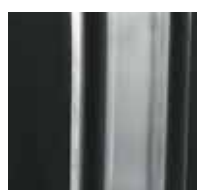

Circumferential robust aluminium frame with shock edge protection



1000 V

Workshop Equipment.

Be a MATADOR.



Workshop Equipment.

Page Article Group

Trolleys.

267 Tool Chest RATIO
 267 Workshop Trolley RATIO
 269 Spare Parts for RATIO
 272 Workshop Trolley VARIO
 272 Spare Parts for VARIO

Accessories.

274 Single Hook
 274 Double Hook
 274 Pliers Holder
 274 Round Holder
 274 Small Parts Holder
 274 Wrench Holder
 274 Screwdrivers Holder
 274 Drill Holder
 274 Socket Holder
 274 Cable Holder
 274 Paper Roll Holder
 274 Waste Bin
 274 Tin Holder

Page Article Group

MTS Moduls.

277 Double Open Ended Spanners
 277 Double Open Ended Spanners XL
 277 Ring Ratchet Spanners
 277 Ring Ratchet Spanners XL
 278 Combination Spanners, angled
 278 Combination Spanners
 279 Double Ended Ring Spanners
 279 Spanners XL
 280 Pipe Head Spanners
 280 Spanners Supplement
 280 Nut Drivers with T-Handle
 281 Socket Sets
 283 Tools Set for Spark Plugs
 283 Socket Sets
 284 Screwdriver Sockets
 285 Socket Set
 286 Impact Sockets
 286 Pneumatic Tools
 287 Pliers
 287 Circlip Pliers
 288 Screwdrivers
 289 Precision Tools Set
 289 T-Handle Wrenches
 289 Files
 290 Mechanic's Tools Basic
 291 Cutting Tools
 292 Measuring instruments
 292 Torque tools
 293 Empty Modules
 293 MTS Self Cutting Module

Page Article Group

Tool assortments RATIO.

294 RATIO „smartyCAR“
 295 RATIO „Universal“
 296 RATIO „Industrial“
 297 RATIO „Automotive“
 298 RATIO „Truck“
 299 RATIO „Automotive XL“
 300 RATIO „Ford“
 301 RATIO „Mercedes-Benz“
 302 RATIO „MTS unlimited edition“

Tool assortments VARIO.

309 VARIO „175“



The MATADOR workshop trolleys.
Two basic models - and almost endless varieties.

R RATIO



The premium class.
Big and sturdy.
W 795 mm x D 470 mm x H 1000 mm.



The performance class.

Versatile and flexible.

W 790 mm x D 580 mm x H 940 mm.

All good things come in threes. The MATADOR workshop trolleys.

Three models - and almost endless varieties.



R RATIO

V VARIO



RATIO.
7 or 8 drawers.

VARIO.
6, 7 or 8 drawers.

Quality starts with the sheet thickness.

MATADOR's new workshop trolley RATIO is the premium solution for all users who need a bigger trolley than QUADRO who don't need a VARIO premium trolley.

Generous dimensions, high capacity and loadability in daily use, easily rollable and upgradeable with accessories of our comprehensive range thanks to square perforation on the side panels - that's RATIO.

The RATIO is designed for heavy industrial applications, its high-performance drawer rails have been thoroughly tested on 40.000 opening cycles.

MATADOR's top model is designed to meet the demanding workaday tasks in workshops and maintenance areas. VARIO is not only a workshop trolley, VARIO is a concept.

Made of 1.75 mm top quality steel sheet, produced with utmost precision on fully automatic CNC press brakes, CNC laser cutting machines and state-of-the-art chipping units, assembled by robot welders and finally powder coated in a modern painting plant VARIO meets top level quality standards. VARIO is available in three standard versions, either with 6, 7 or 8 drawers and painted in white aluminium (RAL 9006) or black (RAL 9005).

By the way: You will receive VARIO fully assembled and packed on a pallet - simply roll down and start working. Our service to save your time.

As with cars the torsion resistance of a workshop trolley is mainly determined by the thickness of the metal sheet.

As the sheet thickness cannot be seen at first glance many sellers save on the material and use only steel sheets with a thickness of 0.7-1.0 mm. The joy of the low price is only short-lived as loadability and lifetime are only moderate.

By contrast the MATADOR workshop trolley VARIO is made with a sheet thickness of even 1.75 mm, this is almost double the thickness as other models. Thus the VARIO reaches a very high level of stability and torsion resistance which you cannot only feel but even hear. No more shaking when closing the drawers, no creaking chassis when rolling - test yourself.

Trust the inner values and enjoy solid industrial quality.

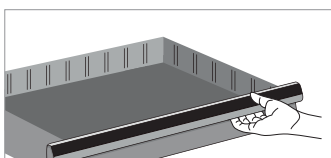

Standard Single lock the drawers on all models

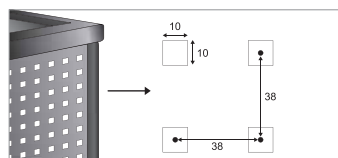

Standard square perforation for wide range of accessories









All at a glance.

Workshop trolleys with 6, 7 or 8 drawers.

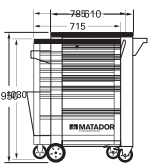
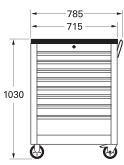
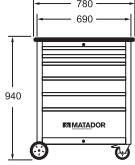
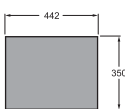
Concentration on the essentials.

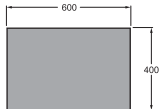
Compact dimensions or big size. Wide or narrow. With 6, 7 or 8 drawers. With extra broad chassis. In silver-aluminium/black, black, red, blue, green or any other color of your choice. With accessories. Empty or fully equipped with tools.

MATADOR workshop trolley range at a glance.

Short Description	Unit					
Model						
External dimensions	mm					
						
Internal dimensions of the drawers	mm					
						
Number of drawers	6		7		6 7 8	
Individual locking of the drawers			<input checked="" type="checkbox"/>		<input checked="" type="checkbox"/>	
„One-at-a-time“ loading system			<input checked="" type="checkbox"/>		<input checked="" type="checkbox"/>	
Height of drawers	mm	4 x 80 1 x 160 1 x 240	5 x 75 2 x 154	2 x 50 3 x 100 1 x 200	3 x 50 3 x 100 1 x 150	5 x 50 2 x 100 1 x 150
Capacity / drawer	kg	35	45	35	35	35
Total load capacity	kg	240	500	750	750	750
Perforation	mm	10 x 38	10 x 38	10 x 38	10 x 38	10 x 38
Empty Weight	kg	55	65	62,5	67,5	72,5
Art. Code		8162 0020	8163 0020	8164 0001	8164 0011	8164 0021
Packing unit		Outer carton: B 800 x T 600 x H 1100 mm Gross weight / pc 60 kg 1 pc / pallet	Outer carton: B 780 x T 530 x H 930 mm Gross weight / pc 70 kg 1 pc / pallet	Outer carton: B 870 x T 750 x H 1080 mm Gross weight / pc 68 / 73 / 78 kg 1 pc / pallet		

MATADOR RATIO.

7 drawers. For tools and more.

The premium class.

Durable ABS worktop with several compartments for small parts and holders for screwdrivers.



Ergonomic handle for convenient pushing, pulling and turning even when fully loaded.

Ball-bearing high-performance slides.

Fully extendable drawers (real 100%).



Rounded edges and integrated corner damage protection.

Both side panels with square perforation for assembly of accessories.

3-level locking system: central locking, single-locked drawers, mechanical interlock („one at-a-time“ locking system).

Premium powder coating in silver-aluminium / black (RAL 9006 / 9005).



2 large ball-bearing castors.

2 flexible castors with brake.

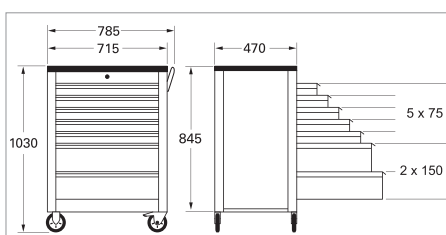

External dimensions

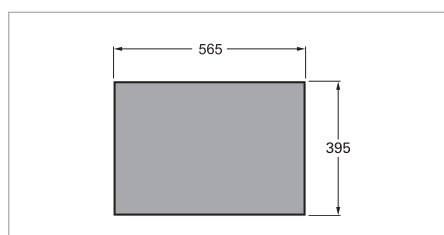

Internal dimensions of drawers



No need to be modest in terms of space. The perfect workstation.

■ Tool Chest **RATIO +3**

- Stable steel sheet construction
- Premium powder coating in silver-aluminium / black (RAL 9006 / 9005)
- With 3 drawers: 3 x 75 mm, all drawers 100% extendable, loadable with 45 kg each
- Single-locked drawers and „one-at-a-time“ locking system
- Ball-bearing precision slides
- Side and back panels with square perforation for assembly of accessories
- Stable, extremely durable handle
- Central locking with cylinder lock

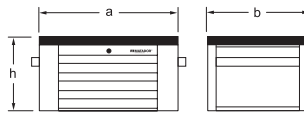

Art. Code	h mm	a mm	b mm	kg	
8163 0019	365	700	460	22	1

■ Workshop Trolley **RATIO**

- Stable steel sheet construction
- ABS worktop with practical compartments for small parts
- Premium powder coating in silver-aluminium / black (RAL 9006 / 9005)
- Total load capacity 500 kg
- With 7 drawers: 5 x 75 mm, 2 x 154 mm, all drawers 100% extendable, loadable with 45 kg each
- Single-locked drawers and „one-at-a-time“ locking system
- Ball-bearing precision slides
- Side and back panels with square perforation for assembly of accessories
- Solid rubber castors including 2 ball-bearing fixed castors and 2 mobile castors with fixing brake
- Stable, extremely durable handle
- Central locking with cylinder lock

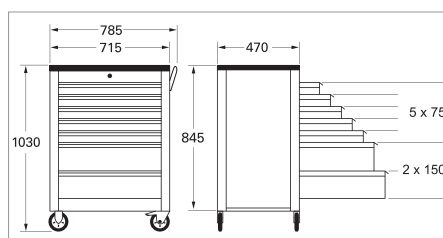

Art. Code	h mm	a mm	b mm	kg	
8163 0020	1030	785	470	65	1
8163 0030	1030	785	470	66	1



■ Workshop Trolley RATIO 7+3



- Stable steel sheet construction
- ABS worktop with practical compartments for small parts
- Premium powder coating in silver-aluminium / black (RAL 9006 / 9005)
- Total load capacity 500 kg
- With 10 drawers: all drawers 100% extendable, loadable with 40 kg each
- Single-locked drawers and „one-at-a-time“-locking system
- Ball-bearing precision slides
- Side and back panels with square perforation for assembly of accessories
- Solid rubber castors including 2 ball-bearing fixed castors and 2 mobile castors with fixing brake
- Stable, extremely durable handle
- Central locking with cylinder lock

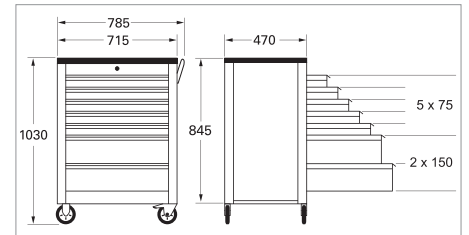

Art. Code

8163 0021



h mm

1370



a mm

700



b mm

460



kg

29



1

■ Workshop Trolley RATIO 7+3/3



- Stable steel sheet construction
- ABS worktop with practical compartments for small parts
- Premium powder coating in silver-aluminium / black (RAL 9006 / 9005)
- Total load capacity 500 kg
- With 13 drawers: all drawers 100% extendable, loadable with 40 kg each
- Single-locked drawers and „one-at-a-time“-locking system
- Ball-bearing precision slides
- Side and back panels with square perforation for assembly of accessories
- Solid rubber castors including 2 ball-bearing fixed castors and 2 mobile castors with fixing brake
- Stable, extremely durable handle
- Central locking with cylinder lock

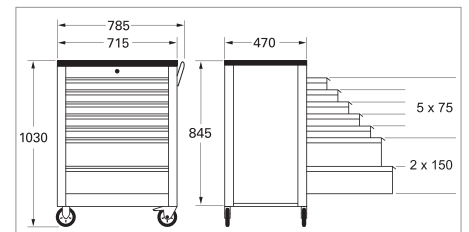

Art. Code

8163 0022



h mm

1455



a mm

700



b mm

460



kg

116



1

■ Workshop Trolley RATIO 10+3/3

- Stable steel sheet construction
- ABS worktop with practical compartments for small parts
- Premium powder coating in silver-aluminium / black (RAL 9006 / 9005)
- Total load capacity 500 kg
- With 13 drawers: all drawers 100% extendable, loadable with 40 kg each
- Single-locked drawers and „one-at-a-time“-locking system
- Ball-bearing precision slides
- Side and back panels with square perforation for assembly of accessories
- Solid rubber castors including 2 ball-bearing fixed castors and 2 mobile castors with fixing brake
- Stable, extremely durable handle
- Central locking with cylinder lock

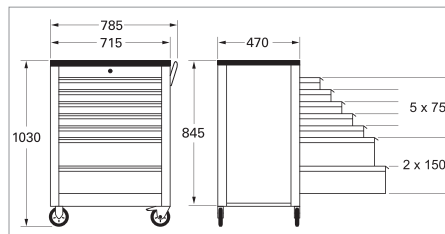

Art. Code	h mm	a mm	b mm	kg	
8163 0025	1455	700	460	116	1

Spare parts for workshop trolleys. Quick help for small problems.

■ Spare Parts for RATIO

Art. Code		kg	
8163 0290	RATIO: replacement lock	0,250	1
8163 0291	RATIO: replacement handle	0,700	1
8163 0292	RATIO: Replacement telescopic rails	0,150	1
8163 0293	RATIO: replacement roll	0,500	1
8163 0294	RATIO: replacement roll, fixed	0,750	1
8163 0299	RATIO: spare key	--	1

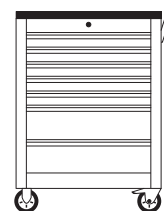

MATADOR VARIO. Pleasure before business.

The performance class. Variable, flexible and of an outstanding quality.



Body made of high-quality steel sheet 1.75 mm, reinforced frame.



Optional: laptop holder or variable working platform.

Optional: lockable side cabinet.

Optional: tray, paper roll holder and waste bin.

6, 7 or 8 drawers, 100% fully extendable and with aluminium handle strips that can be labelled.



Side and back panels with square perforation.

4-level locking system: central locking, single-locked drawers, mechanical interlock („one-at-a-time“ locking system) and optional locking bar.

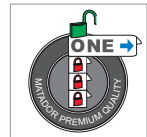

All-round impact protection and heel protection as well as integrated corner fenders.

2 extra big special castors (150 mm) and 2 flexible castors with fixing brake.

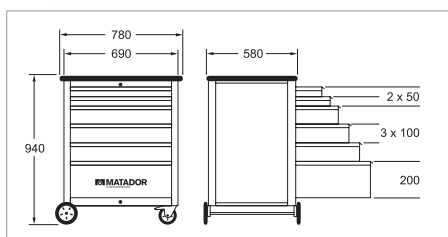

External dimensions

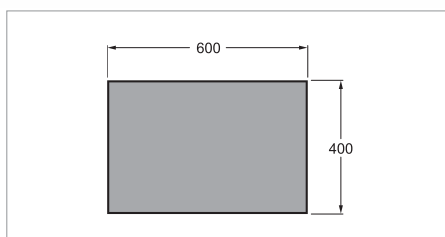

Internal dimensions of drawers

 Quality locking system.

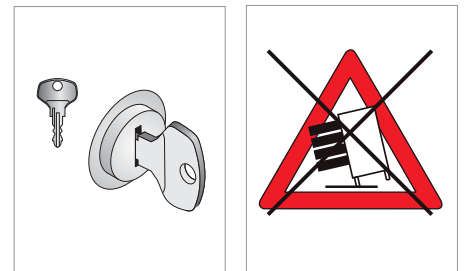

Central locking with top-quality cylinder lock and single-locked drawers, no unintended opening

 One drawer at a time.

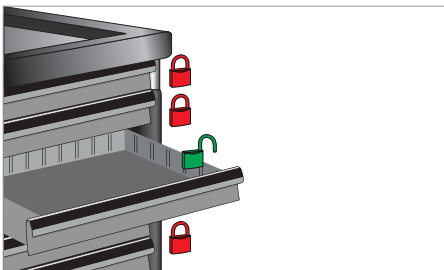

Mechanical interlock of the drawers so that only one can be opened at a time (can be suspended)

 Theft protection.

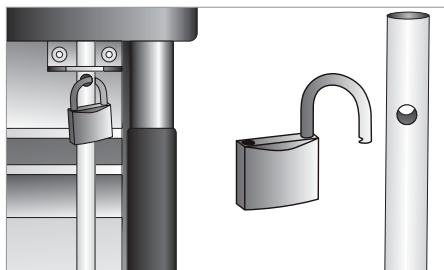

Optional locking bar incl. padlock serves as additional protection of the trolley against theft

 Robust ABS worktop.

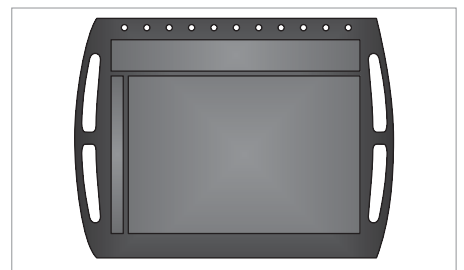

ABS worktop with compartments for small parts, screwdriver holders and handles on both sides

 Big range of accessories.

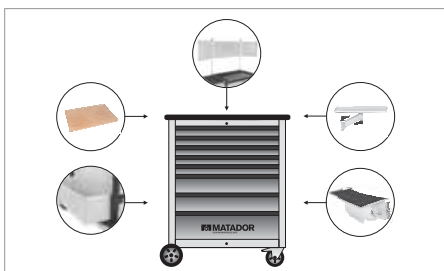

All-round square perforation for assembly of accessories, make your VARIO a real mobile workstation

 Precision slides.

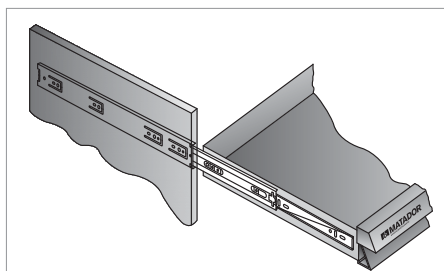

Quality slides: ball-bearing supported, fully extendable, highly loadable and especially durable

 XL drawer volume.

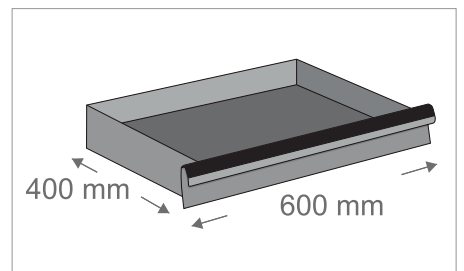

More drawer volume than any other current model for plenty of storage space

 Fixing brake.

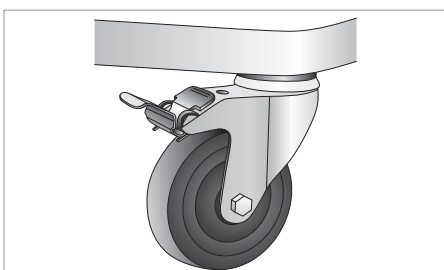

Stable fixing brakes at the mobile castors for perfect stand

 High-performance castors.

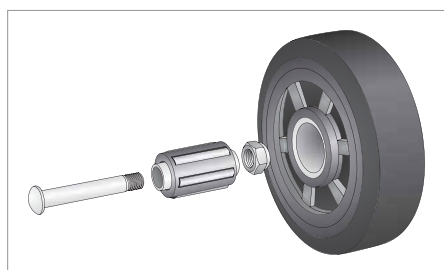

Ball-bearing high-performance castors for convenient rolling and high loadability

 Labels.

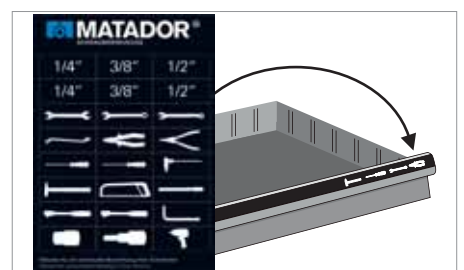







Individual drawer labelling with pictogram labels for quick and easy orientation

Perfection in detail.

■ Workshop Trolley VARIO

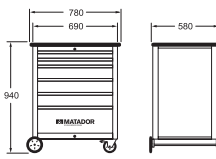
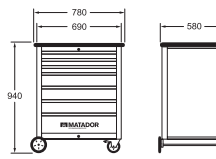
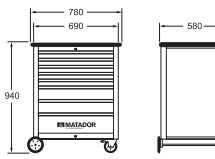
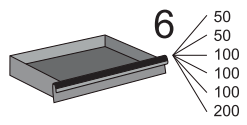
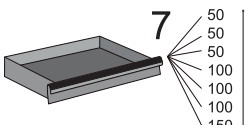
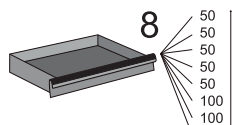

Short Description	VARIO with 6 drawers	VARIO with 7 drawers	VARIO with 8 drawers
	<ul style="list-style-type: none"> - 6 drawers - Color silver-aluminium RAL 9006 	<ul style="list-style-type: none"> - 7 drawers - Color silver-aluminium RAL 9006 	<ul style="list-style-type: none"> - 8 drawers - Color silver-aluminium RAL 9006
	 Art. Code 8164 0001  kg 62,5	 Art. Code 8164 0011  kg 67,5	 Art. Code 8164 0021  kg 72,5
Dimensions in mm			
Allocation of drawers, height in mm			

Spare parts for workshop trolleys.

Quick help for small problems.

■ Spare Parts for VARIO



Art. Code	VARIO	g	
8164 0290	Spare lock with 2 keys	250	1
8164 0291	Spare worktop with assembly material	1500	1
8164 0295	Spare corner protector	20	1

Vario Tuning.

Make the best of your VARIO.

Special accessories for assembly onto the side panels of the VARIO trolley. Not suitable for QUADRO or RATIO (unless stated otherwise).

■ Tin Holder



- Capacity up to 5 tins

Art. Code	L mm	B mm	H mm	g	
8164 0203	480	90	85	1110	1

■ Laptop Holder



- Ideal as additional worktop/storage place
- With quick-release levers and double quick fixation
- Mountable to each of the 4 VARIO pillars

Art. Code	L mm	B mm	g	
8164 0205	420	300	4500	1

■ Paper Roll Holder



- With tray
- With brackets, fit into the square perforation
- Delivery without paper roll

Art. Code	L mm	B mm	g	
8164 0201	535	200	1650	1

■ Anti-slip Mat



- Ideal for each drawer without dividers / partition system

Art. Code	L mm	B mm	H mm	g	
8164 0211	570	380	3	200	1

Functional helpers. High practical effect, low costs.

Make the most of your tool trolley.



■ Cable Drum



Art. Code	m	g	
8141 0001	10	2040	1

General Accessories.

For workshop trolleys, workbenches and perforated panels.

Suitable for panels with square perforation 10 x 38 mm.

Double Hook



Art. Code	mm	g	
8141 0110	50	80	1
8141 0111	150	180	1

Pliers Holder



Art. Code	mm	g	
8141 0115	55 x 70	66	1

Single Hook



Art. Code	mm	g	
8141 0100	50	40	1
8141 0101	150	60	1

Round Holder



Art. Code	mm	g	
8141 0120	65 x 25	60	1

Small Parts Holder



Art. Code	mm	g	
8141 0130	150 x 55	200	1

Wrench Holder

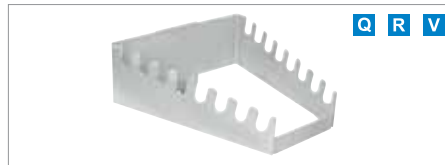

Art. Code	mm	g	
8141 0140	8x	400	1

Screwdrivers Holder



Art. Code	mm	g	
8141 0150	6x	200	1

Drill Holder

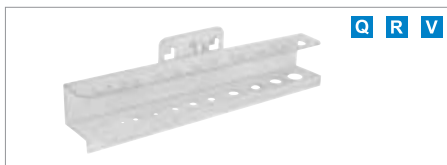

Art. Code	mm	g	
8141 0160	14x	200	1

Socket Holderr

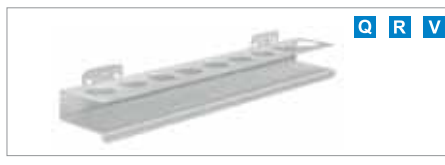

Art. Code	mm	g	
8141 0180	9x	500	1

Cable Holder

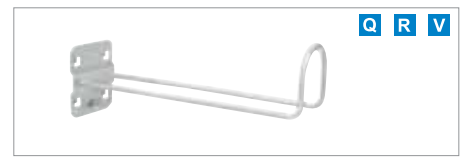

Art. Code	mm	g	
8141 0190	150	200	1

Paper Roll Holder



Art. Code	mm	g	
8141 0200		500	1

Waste Bin



Art. Code	mm	g	
8141 0210		1000	1

Tin Holder



Art. Code	mm	g	
8141 0220	300 x 70	350	1

MTS modules for workshop trolleys. Perfect organization. See what is missing.

Soft foam inlays with black and blue tools contours.

Practice-oriented product features: Environmentally friendly, resistant to oils, fuels and detergents, heat-resistant up to 112 °C and non-flammable.



Easy recognition of missing tools.

Perfect order.



MTS - saves costs, time and nerves.

Already more than 10 years ago MATADOR supplied the first workshop trolleys with MTS inlays.

Today it is a standard but back then it was a real innovation: „MATADOR Tool System“ MTS.



No organization, no control.

See what is missing.

MTS are black and blue inlays made of 2-component soft foam into which tools can be embedded vibration-proof:

Missing tools can quickly be recognized which is budget-friendly and cost-saving



Better organization but no indication of missing tools.

Better organization and maximum cleanliness.

No more searching, perfect order. You'd better spend your time with more important activities.

And for maximum cleanliness after the work is done: Simply clean under running water, dry - ready.



Perfect organization, see what's missing.

MTS - all benefits at a glance.

- Designated place created for every tool
- Enables the operator to find the tools faster
- Provides a visual indication of any missing tool
- Protects tools from damage
- Supports 6 sigma in your workplace
- Promotes tool accountability
- Enhances productivity
- Speeds up inventory checks and audits







































All at a glance. 86 modules for tools, countless varieties.











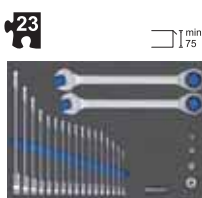

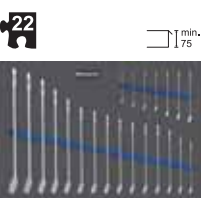
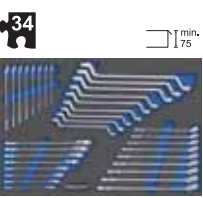
Perfectly organized tools for every field of application.

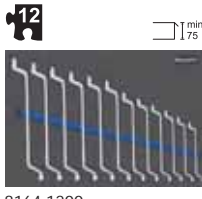
R RATIO **V** VARIO

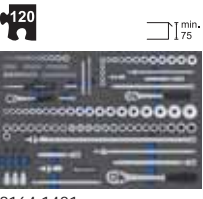
R/V 1/3

 8164 1100 8164 2100	 8164 3100 8164 4100	 8164 1183	 8164 1185 8164 2185	 8164 1190 8164 2190	 8164 1320	 8164 1671 8164 2671 8164 3671 8164 4671	 8164 1201 8164 1203	 8164 1301 8164 1302 8164 1303	 8164 3093	 8164 3081	 8164 1401 8164 1402 8164 1403
 8164 4081	 8164 1481	 8164 4078	 8164 4079	 8164 4092	 8164 7481	 8164 7475	 8164 7575	 8164 1700	 8164 1500	 8164 1501	 8164 1502
 8164 1503	 8164 1504	 8164 1505	 8164 1615	 8164 1616	 8164 1620	 8164 1653	 8164 1663	 8164 1775	 8164 1701	 8164 6176	 8164 6190

R/V 3/3

 8164 2183	 8164 3190	 8164 3185	 8164 1195 8164 4185	 8164 0096
 8164 1200	 8164 1251	 8164 1411 8164 1412 8164 1413	 8164 1421 8164 1422	 8164 0095
 8164 1441	 8164 1705	 8164 1786	 8164 1798	 8164 0099



Modules for RATIO and VARIO.

Mehr Platz, mehr Werkzeug. More space, more tools.

■ MTS-R/V: Double Open Ended Spanners

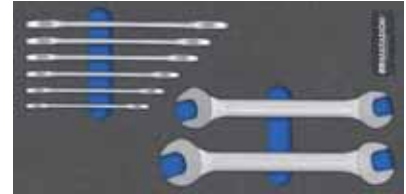
- Two-colored MTS inlay with 8 pcs. set of double open ended spanners
- 6 x 7 - 20 x 22 mm (1/4 x 5/16 - 3/4 x 25/312" AF)
- Suitable for RATIO and VARIO and in combination with empty modules also QUADRO



Art. Code	a mm	b mm	g	
8164 1100  MM	390	190	800	1
Content	 0100 6 x 7 - 8 x 9 - 10 x 11 - 12 x 13 - 14 x 15 - 16 x 17 - 18 x 19 - 20 x 22 mm			



MTS MATADOR TOOL SYSTEM.

1/3

■ MTS-R/V: Double Open Ended Spanners XL

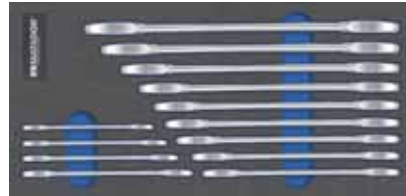
- Two-colored MTS inlay with 13 pcs. set of double open ended spanners
- 6 x 7 - 30 x 32 mm (1/4 x 5/16 - 1.1/16 x 1.1/4" AF)
- Suitable for RATIO and VARIO and in combination with empty modules also QUADRO



Art. Code	a mm	b mm	g	
8164 3100  MM	390	190	2750	1
8164 4100  AF	390	190	2300	1
Content	 0100 6 x 7 - 8 x 9 - 10 x 11 - 12 x 13 - 14 x 15 - 16 x 17 - 18 x 19 - 20 x 22 - 21 x 23 - 24 x 26 - 25 x 28 - 27 x 30 - 30 x 32 mm AF: 1/4 x 5/16 - 5/16 x 3/8 - 3/8 x 7/16 - 7/16 x 1/2 - 1/2 x 9/16 - 9/16 x 5/8 - 5/8 x 11/16 - 11/16 x 3/4 - 3/4 x 25/32 13/16 x 7/8 - 15/16 x 1 - 1 x 1/8 - 1.1/16 x 1.1/4"			



MTS MATADOR TOOL SYSTEM.

1/3

■ MTS-R/V: Ring Ratchet Spanners

- Two-colored MTS inlay with 14 pcs. set of ring ratchet spanners
- 6 - 22 mm with adaptors for sockets
- Suitable for RATIO and VARIO and in combination with empty modules also QUADRO



Art. Code	a mm	b mm	g	
8164 1183  MM	390	190	1400	1
Content	 0183 6 - 8 - 10 - 11 - 13 - 16 - 17 - 18 - 19 - 22 mm  0186 6,3 (1/4) Bit - 6,3 (1/4) - 10 (3/8) - 12,5 (1/2) mm			



MTS MATADOR TOOL SYSTEM.

1/3

■ MTS-R/V: Ring Ratchet Spanners XL

- Two-colored MTS inlay with 23 pcs. set of ring ratchet spanners
- 6 - 32 mm with adaptors for sockets
- Suitable for RATIO and VARIO and in combination with empty modules also QUADRO



Art. Code	a mm	b mm	g	
8164 2183  MM	570	390	4900	1
Content	 0183 6 - 7 - 8 - 9 - 10 - 11 - 12 - 13 - 14 - 15 - 16 - 17 - 18 - 19 - 22 - 24 - 27 - 30 - 32 mm  0186 6,3 (1/4) Bit - 6,3 (1/4) - 10 (3/8) - 12,5 (1/2) mm			

MTS MATADOR TOOL SYSTEM.

3/3

■ MTS-R/V: Combination Spanners, angled

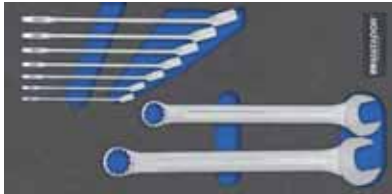

- Two-colored MTS inlay with 9 pcs. set of combination spanners DIN 3113 A
- 6 - 22 mm (1/4 - 13/16" AF)
- Suitable for RATIO and VARIO and in combination with empty modules also QUADRO

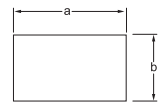

Art. Code	a mm	b mm	g	
8164 1185 MM	390	190	900	1
Content	0185 6 - 8 - 10 - 11 - 13 - 14 - 17 - 19 - 22 mm			



1/3

■ MTS-R/V: Combination Spanners XL, angled

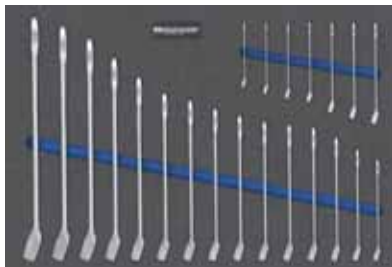

- Two-colored MTS inlay with 22 pcs. set of combination spanners DIN 3113 A
- 6 - 34 mm
- Suitable for RATIO and VARIO and in combination with empty modules also QUADRO

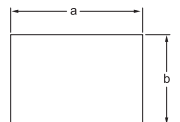

Art. Code	a mm	b mm	g	
8164 3185 MM	570	390	4100	1
Content	0185 6 - 7 - 8 - 9 - 10 - 11 - 12 - 13 - 14 - 15 - 16 - 17 - 18 - 19 - 20 - 21 - 22 - 24 - 27 - 30 - 32 - 34 mm			



3/3

■ MTS-R/V: Combination Spanners, offset

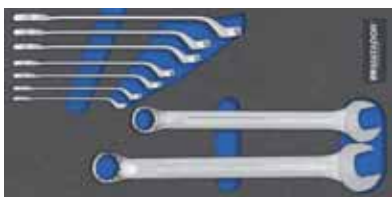

- Two-colored MTS inlay with 9 pcs. set of combination spanners DIN 3113 B
- 6 - 22 mm (1/4 - 7/8" AF)
- Suitable for RATIO and VARIO and in combination with empty modules also QUADRO

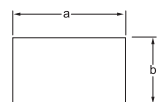

Art. Code	a mm	b mm	g	
8164 1190 MM	390	190	1100	1
Content	0190 6 - 8 - 10 - 11 - 13 - 14 - 17 - 19 - 22 mm			



1/3

■ MTS-R/V: Combination Spanners, offset XL

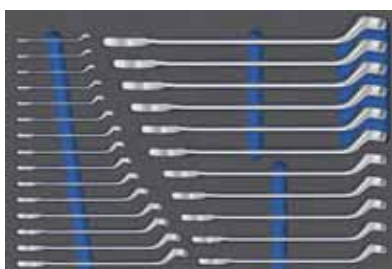

- Two-colored MTS inlay with 26 pcs. set of combination spanners DIN 3113 B
- 6 - 32 mm
- Suitable for RATIO and VARIO and in combination with empty modules also QUADRO

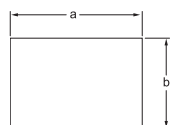

Art. Code	a mm	b mm	g	
8164 3190 MM	570	390	7300	1
Content	0190 6 - 7 - 8 - 9 - 10 - 11 - 12 - 13 - 14 - 15 - 16 - 17 - 18 - 19 - 20 - 21 - 22 - 23 - 24 - 25 - 26 - 27 - 28 - 29 - 30 - 32 mm			



3/3

■ MTS-R/V: Double Ended Ring Spanners, offset



- Two-colored MTS inlay with 12 pcs. set of double ended ring spanners
- 6 x 7 - 30 x 32 mm
- Suitable for RATIO and VARIO and in combination with empty modules also QUADRO

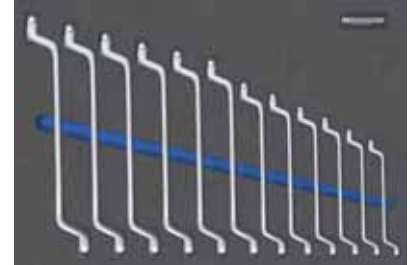
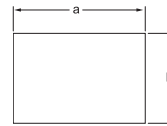

Art. Code	a mm	b mm	g	
8164 1200 MM	570	390	3300	1
Content 0200	6 x 7 - 8 x 9 - 10 x 11 - 12 x 13 - 14 x 15 - 16 x 17 - 18 x 19 - 20 x 22 - 21 x 23 - 24 x 27 - 25 x 28 - 30 x 32 mm			

MTS MATADOR TOOL SYSTEM.

3/3

■ MTS-R/V: Spanners XL

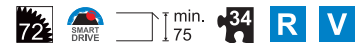

- Two-colored MTS inlay with 34 pcs. set of spanners
- All important sizes
- Combination Spanners DIN 3113 A 6 - 22 mm
- Ring ratchet spanners with GEARplus[®]-technique 8 - 19 mm
- Double Ended Ring Spanners 6 x 7 - 21 x 23 mm
- Suitable for RATIO and VARIO and in combination with empty modules also QUADRO

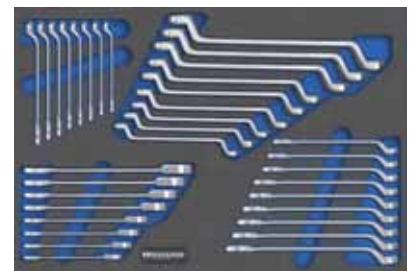
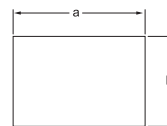

Art. Code	a mm	b mm	g	
8164 1194 MM	570	390	4750	1
Content 0100	6 x 7 - 8 x 9 - 10 x 11 - 12 x 13 - 14 x 15 - 16 x 17 - 18 x 19 - 20 x 22 mm			
0190	6 - 7 - 8 - 9 - 10 - 11 - 12 - 13 - 14 - 15 - 16 - 17 - 18 - 19 - 20 - 21 - 22 mm			
0200	6 x 7 - 8 x 9 - 10 x 11 - 12 x 13 - 14 x 15 - 16 x 17 - 18 x 19 - 20 x 22 - 21 x 23 mm			
8164 1195 MM	570	390	4750	1
Content 0183	8 - 10 - 11 - 13 - 16 - 17 - 18 - 19 mm			
0190	6 - 7 - 8 - 9 - 10 - 11 - 12 - 13 - 14 - 15 - 16 - 17 - 18 - 19 - 20 - 21 - 22 mm			
0200	6 x 7 - 8 x 9 - 10 x 11 - 12 x 13 - 14 x 15 - 16 x 17 - 18 x 19 - 20 x 22 - 21 x 23 mm			
8164 4185 MM	570	390	4750	1
Content 0183	8 - 10 - 11 - 13 - 16 - 17 - 18 - 19 mm			
0185	6 - 7 - 8 - 9 - 10 - 11 - 12 - 13 - 14 - 15 - 16 - 17 - 18 - 19 - 20 - 21 - 22 mm			
0200	6 x 7 - 8 x 9 - 10 x 11 - 12 x 13 - 14 x 15 - 16 x 17 - 18 x 19 - 20 x 22 - 21 x 23 mm			

MTS MATADOR TOOL SYSTEM.

3/3

■ MTS-R/V: Pipe Head Spanners



- Two-colored MTS inlay with 12 pcs. set of pipe head spanners
- 8 - 19 mm

- Suitable for RATIO and VARIO and in combination with empty modules also QUADRO

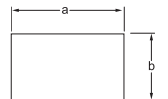
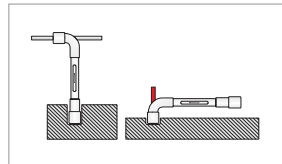

Art. Code	a mm	b mm	g	
8164 1320 MM	390	190	2500	1
Content 0320	8 - 9 - 10 - 11 - 12 - 13 - 14 - 15 - 16 - 17 - 18 - 19 mm			



1/3

■ MTS-R/V: Spanners Supplement



- Two-colored MTS inlay with 15 pcs. set of spanners for confined spaces
- Suitable for RATIO and VARIO and in combination with empty modules also QUADRO

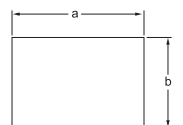
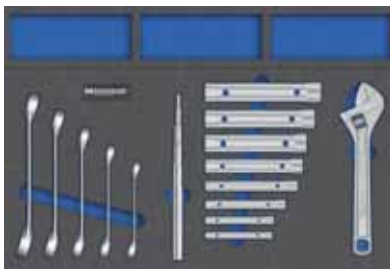

Art. Code	a mm	b mm	g	
8164 1251	570	390	2300	1
Content 0251	8 x 10 - 10 x 12 - 11 x 13 - 14 x 17 - 19 x 22 mm			
0380	6 x 7 - 8 x 9 - 10 x 11 - 12 x 13 - 14 x 15 - 16 x 17 - 18 x 19 - 20 x 22 mm			
0342	ø 5 - 12 mm			
0591	250 mm / 10"			



3/3

■ MTS-R/V: Nut Drivers with T-Handle



- Two-colored MTS inlay with 3 pcs. set of nut drivers with T-handle
- Suitable for RATIO and VARIO and in combination with empty modules also QUADRO

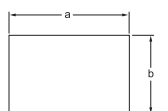
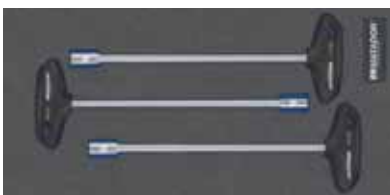

Art. Code	a mm	b mm	g	
8164 1671	390	190	400	1
Content 0671	6 - 7 - 8 x 230 mm			
8164 2671	390	190	400	1
Content 0671	9 - 10 - 11 x 230 mm			
8164 3671	390	190	400	1
Inhalt 0671	12 - 13 - 14 x 230 mm			
8164 4671	390	190	400	1
Content 0671	8 - 10 - 13 x 230 mm			



1/3

■ MTS-R/V: Socket Set 6.3 (1/4)

- Two-colored MTS inlay with 85 pcs. socket set
- Suitable for RATIO and VARIO and in combination with empty modules also QUADRO

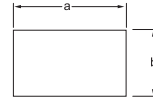

Art. Code		a mm	b mm	g
8164 1201		390	190	1600
8164 1203		390	190	1600
Content				
	0442	1,5 - 10 mm		
	2061			
	2065	50, 100 mm		
	2068			
	2073	150 mm		
	2075	4 - 4,5 - 5 - 5,5 - 6 - 7 - 8 - 9 - 10 - 11 - 13 mm AF: 1/8 - 5/32 - 3/16 - 7/32 - 1/4 - 9/32 - 5/16 - 11/32 - 3/8 - 7/16 - 1/2"		
	2076	4 - 5,5 - 7 x 32 mm		
	2077	PH 1 - PH 2 - PH 3 x 32 mm		
	2078	3 - 4 - 5 - 6 - 8 x 32 mm		
	2083	6,3 (1/4) - 10 (3/8)		
	2084	6,3 (1/4) - 6,3 (1/4) Bit		
	2090	E4 - E5 - E6 - E7 - E8 - E10 - E11		
	2092	T8 - T10 - T15 - T20 - T25 - T27 - T30 - T40 x 32 mm		
	7052	72 teeth reversible bit ratchet including adapter for external square drive 6.3 (1/4)		
		Bit-Box		
		6,3 (1/4) 3 - 4 - 5 - 6 mm		
		6,3 (1/4) 3 - 4 - 5 - 6 mm		
		6,3 (1/4) PH 1 - PH 2 - PH 2 - PH 3		
		6,3 (1/4) PZ 1 - PZ 2 - PZ 2 - PZ 3		
		6,3 (1/4) T10 - T15 - T20 - T25 - T27 - T30 - T40		
		6,3 (1/4) T10 - T15 - T20 - T25 - T27 - T30 - T40		



MTS MATADOR
TOOL SYSTEM.

1/3

■ MTS-R/V: Socket Set 10 (3/8)

- Two-colored MTS inlay with 22 pcs. socket set
- Suitable for RATIO and VARIO and in combination with empty modules also QUADRO



Art. Code		a mm	b mm	g
8164 1301		390	190	1320
8164 1302		390	190	1320
8164 1303		390	190	1200
Content				
	3061			
	3065	125, 250 mm		
	3068			
	3083	10 (3/8) - 12,5 (1/2)		
	3075	6 - 7 - 8 - 9 - 10 - 11 - 12 - 13 - 14 - 15 - 16 - 17 - 18 - 19 - 20 - 21 - 22 mm AF: 1/4 - 5/16 - 11/32 - 3/8 - 7/16 - 1/2 - 9/16 - 19/32 - 5/8 - 11/16 - 3/4 - 25/32 - 13/16 - 7/8"		

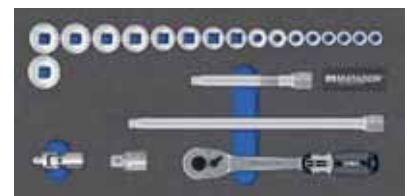

MTS MATADOR
TOOL SYSTEM.

1/3

■ MTS-R/V: Socket Set 10 (3/8) Hex, TORX[®], XZN



- Two-colored MTS inlay with 36 pcs. set of flare nut wrenches and crow foot spanners
- Suitable for RATIO and VARIO and in combination with empty modules also QUADRO

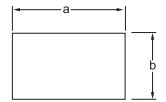
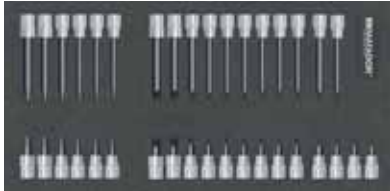

Art. Code	a mm	b mm	g
8164 3078 MM	390	190	2400 1
Content	10 mm 3/8 3078 4 - 5 - 6 - 7 - 8 - 10 x 48 mm 4 - 5 - 6 - 7 - 8 - 10 x 92 mm 10 mm 3/8 3079 M5 - M6 - M8 - M10 x 48 mm M8 - M10 x 92 mm 10 mm 3/8 3092 T15 - T20 - T25 - T27 - T30 - T40 - T45 - T50 - T55 x 48 mm T15 - T20 - T25 - T27 - T30 - T40 - T45 - T50 - T55 x 92 mm		



1/3

■ MTS-R/V: Socket Set 6,3 (1/4), 10 (3/8) long type



- Two-colored MTS inlay with 32 pcs. set of flare nut wrenches and crow foot spanners
- Suitable for RATIO and VARIO and in combination with empty modules also QUADRO

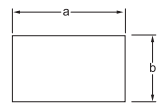
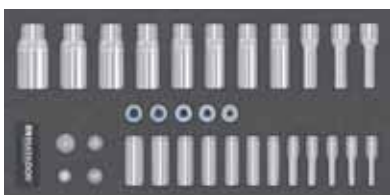

Art. Code	a mm	b mm	g
8164 3082 MM	390	190	2400 1
Content	6.3 mm 1/4 2081 4 - 4.5 - 5 - 5.5 - 6 - 7 - 8 - 9 - 10 - 11 - 12 - 13 - 14 mm 10 mm 3/8 3081 8 - 10 - 11 - 12 - 13 - 14 - 15 - 17 - 19 - 21 - 22 mm 10 mm 3/8 3079 E8 - E10 - E11 - E12 - E14 6.3 mm 1/4 2083 10 mm 3/8 10 mm 3/8 3083 12 mm 1/2		



1/3

■ MTS-R/V: Socket Set 10 (3/8) supplement



- Two-colored MTS inlay with 28 pcs. set of flare nut wrenches and crow foot spanners
- Suitable for RATIO and VARIO and in combination with empty modules also QUADRO

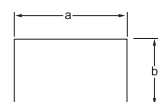

Art. Code	a mm	b mm	g
8164 3093 MM	390	190	1300 1
Content	10 mm 3/8 3078 4 - 5 - 6 - 7 - 8 - 10 mm 10 mm 3/8 3090 E8 - E10 - E11 - E12 - E14 10 mm 3/8 3092 T15 - T20 - T25 - T27 - T30 - T40 - T45 x 48 mm 10 mm 3/8 3093 10 - 11 - 12 - 13 - 14 - 15 - 16 - 17 - 18 - 19 mm		



1/3

■ MTS-R/V: Tools Set for Spark Plugs

- Two-colored MTS inlay with 11 pcs. set of spark plug tools
- Suitable for RATIO and VARIO and in combination with empty modules also QUADRO



Art. Code	a mm	b mm	g	
8164 3081	390	190	1100	1
Content	<ul style="list-style-type: none"> 0372 5/8" x 16 mm 0383 14 mm 0568 205 mm 0633 6 - 24 V 120 mm 0760 13 x 0,05 - 1,00 mm 0781 150 mm 3081 14 - 16 - 18 - 20,8 mm 4082 12,5 (1/2) - 10 (3/8) 			



MTS MATADOR TOOL SYSTEM.

1/3

■ MTS-R/V: Socket Set 12.5 (1/2)

- Two-colored MTS inlay with 22 pcs. socket set
- Suitable for RATIO and VARIO and in combination with empty modules also QUADRO



Art. Code	a mm	b mm	g	
8164 1401	390	190	3300	1
8164 1402	390	190	3300	1
8164 1403	390	190	3100	1
Content	<ul style="list-style-type: none"> 4061 4064 300 mm 4065 125, 250 mm 4068 4075 10 - 11 - 12 - 13 - 14 - 15 - 16 - 17 - 18 - 19 - 20 - 21 - 22 - 24 - 27 - 30 - 32 mm AF: 3/8 - 7/16 - 15/32 - 1/2 - 9/16 - 19/32 - 5/8 - 21/32 - 11/16 - 3/4 - 25/32 - 13/16 - 7/8 - 31/32 - 1.1/8 - 1.5/16 - 1.1/4" 			

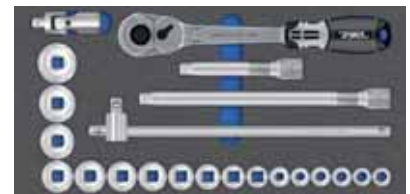

MTS MATADOR TOOL SYSTEM.

1/3

■ MTS-R/V: Sockets 12.5 (1/2), long type

- Two-colored MTS inlay with 14 pcs. of long type sockets
- Suitable for RATIO and VARIO and in combination with empty modules also QUADRO



Art. Code	a mm	b mm	g	
8164 4081	390	190	2400	1
Content	<ul style="list-style-type: none"> 4081 10 - 11 - 12 - 13 - 14 - 15 - 17 - 19 - 21 - 22 - 24 - 27 - 30 - 32 mm 			

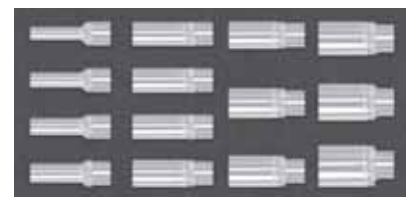

MTS MATADOR TOOL SYSTEM.

1/3

■ MTS-R/V: Screwdriver Sockets Automotive



- Two-colored MTS inlay with 16 pcs. screwdriver socket set
- Suitable for RATIO and VARIO and in combination with empty modules also QUADRO

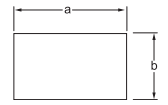

Art. Code	a mm	b mm	g
8164 1481	390	190	1915 1
Content	0568 205 mm 0760 13 x 0,05 - 1,00 mm 4081 16 - 18 - 20,8 mm 4078 5 x 100 - 6 x 100 - 7 x 100 - 8 x 100 mm 4079 M6 x 100 - M8 x 100 - M10 x 100 - M12 x 100 mm 4092 T 45 x 100 - T 55 x 100 - T 70 x 100 mm		



1/3

■ MTS-R/V: Screwdriver Sockets (Hex)

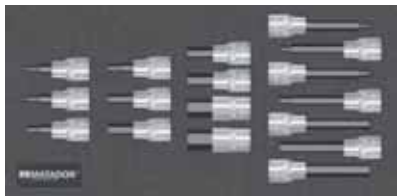

- Two-colored MTS inlay with 16 pcs. screwdriver socket set
- Suitable for RATIO and VARIO and in combination with empty modules also QUADRO

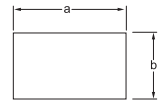

Art. Code	a mm	b mm	g
8164 4078 MM	390	190	2400 1
Content	4078 4 x 62 - 5 x 62 - 6 x 62 - 7 x 62 - 8 x 62 - 10 x 62 - 12 x 62 - 14 x 62 - 17 x 62 - 19 x 62 mm 4 x 100 - 5 x 100 - 6 x 100 - 7 x 100 - 8 x 100 - 10 x 100 - 12 x 100 mm		



1/3

■ MTS-R/V: Screwdriver Sockets (XZN / RIBE[®])

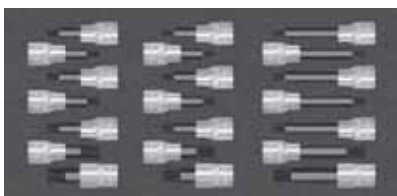

- Two-colored MTS inlay with 21 pcs. screwdriver socket set
- Suitable for RATIO and VARIO and in combination with empty modules also QUADRO

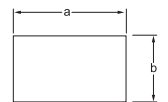

Art. Code	a mm	b mm	g
8164 4079 MM	390	190	2500 1
Content	4079 M5 x 62 - M6 x 62 - M8 x 62 - M10 x 62 - M12 x 62 - M14 x 62 - M16 x 62 mm M5 x 100 - M6 x 100 - M8 x 100 - M10 x 100 - M12 x 100 - M14 x 100 - M16 x 100 mm 4080 M5 x 62 - M6 x 62 - M8 x 62 - M10 x 62 - M12 x 62 - M14 x 62 - M16 x 62 mm		



1/3

■ MTS-R/V: Screwdriver Sockets (TORX[®])



- Two-colored MTS inlay with 39 pcs. screwdriver socket set
- Suitable for RATIO and VARIO and in combination with empty modules also QUADRO

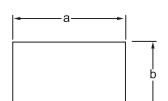

Art. Code	a mm	b mm	g
8164 4092	390	190	3200 1
Content	0444 T10 - T50 4090 E10 - E12 - E14 - E16 - E18 - E20 - E22 - E24 4092 T20 x 62 - T25 x 62 - T27 x 62 - T30 x 62 - T40 x 62 - T45 x 62 - T50 x 62 - T55 x 62 - T60 x 62 - T70 x 62 T80 x 62 - T20 x 100 - T25 x 100 - T27 x 100 - T30 x 100 - T40 x 100 - T45 x 100 - T50 x 100 - T55 x 100 T60 x 100 - T70 x 100 - T80 x 100 mm		



1/3

■ MTS-R/V: Socket Set 6.3 (1/4) - 12.5 (1/2)

- Two-colored MTS inlay with 72 pcs. socket set



Art. Code		a mm	b mm	g
8164 1411	MM	570	390	3900
8164 1412	MM	570	390	3900
8164 1413	AF	570	390	3900
Content	0442 1,5 - 10 mm			
	2061			
	2065 50, 100 mm			
	2068			
	2073 150 mm			
	2075 4 - 4,5 - 5 - 5,5 - 6 - 7 - 8 - 9 - 10 - 11 - 12 - 13 - 14 mm AF: 1/8 - 5/32 - 3/16 - 7/32 - 1/4 - 9/32 - 5/16 - 11/32 - 3/8 - 7/16 - 1/2 - 9/16"			
	2076 4 - 5,5 - 7 x 32 mm			
	2077 PH 1 - PH 2 - PH 3 x 32 mm			
	2078 3 - 4 - 5 - 6 - 8 x 32 mm			
	2090 E4 - E5 - E6 - E7 - E8 - E10 - E11			
	2092 T8 - T10 - T15 - T20 - T25 - T27 - T30 - T40 x 32 mm			
	4061			
	4065 75, 250 mm			
	4068			
	4075 10 - 11 - 12 - 13 - 14 - 15 - 16 - 17 - 18 - 19 - 22 - 24 - 27 - 30 - 32 mm AF: 3/8 - 7/16 - 15/32 - 1/2 - 9/16 - 19/32 - 5/8 - 21/32 - 11/16 - 3/4 - 7/8 - 31/32 - 1.1/8 - 3/16 - 1.1/4"			

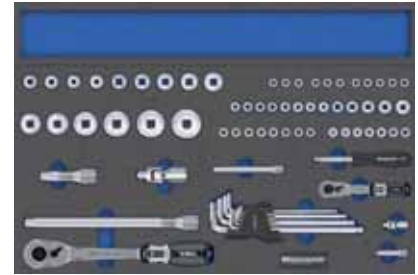

MTS MATADOR TOOL SYSTEM.

3/3

■ MTS-R/V: Socket Set XL

- Two-colored MTS inlay with 120 pcs. socket set



Art. Code		a mm	b mm	g
8164 1421	MM	570	390	9100
8164 1422	MM	570	390	9100
Content	2061			
	2064 115 mm			
	2065 50, 100 mm			
	2068			
	2073 150 mm			
	2075 4 - 4,5 - 5 - 5,5 - 6 - 7 - 8 - 9 - 10 - 11 - 12 - 13 - 14 mm			
	2076 4 - 5,5 - 7 x 32 mm			
	2077 PH 1 - PH 2			
	2077 PZ 1 - PZ 2			
	2078 3 - 4 - 5 - 6 - 8 x 32 mm			
	2090 E4 - E5 - E6 - E7 - E8 - E10 - E11			
	2092 T8 - T10 - T15 - T20 - T25 - T27 - T30 - T40 x 32 mm			
	3061			
	3064 200 mm			
	3065 125, 250 mm			
	3068			
	3075 6 - 7 - 8 - 9 - 10 - 11 - 12 - 13 - 14 - 15 - 16 - 17 - 18 - 19 - 21 - 22 mm			
	4061			
	4064 300 mm			
	4065 125, 250 mm			
	4074 300 mm			
	4068			
	4075 8 - 9 - 10 - 11 - 12 - 13 - 14 - 15 - 16 - 17 - 18 - 19 - 20 - 21 - 22 - 23 - 24 - 27 - 30 - 32 mm			
	4078 5 - 6 - 7 - 8 - 10 - 12 - 14 - 17 - 19 x 62 mm			
	4090 E12 - E14 - E16 - E18 - E20 - E24			
	4092 T20 - T25 - T27 - T30 - T40 - T45 - T50 - T55 - T60 x 62 mm T45 - T55 - T70 x 100 mm			

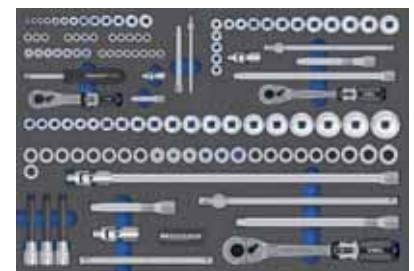

MTS MATADOR TOOL SYSTEM.

3/3

■ MTS-R/V: Impact Sockets (short type)

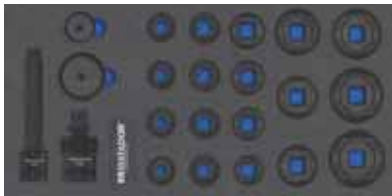

- Two-colored MTS inlay with 24 pcs. impact sockets set
- Suitable for RATIO and VARIO and in combination with empty modules also QUADRO

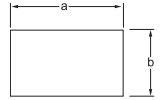

Art. Code	a mm	b mm	g	
8164 7475	390	190	3900	1
Content		7465	125 mm	
		7458		
		7475	10 - 11 - 12 - 13 - 14 - 15 - 16 - 17 - 18 - 19 - 20 - 21 - 22 - 24 - 27 - 30 - 32 - 34 mm	
		7499		



1/3

■ MTS-R/V: Impact Sockets (long type)



- Two-colored MTS inlay with 19 pcs. impact sockets set, long type
- Suitable for RATIO and VARIO and in combination with empty modules also QUADRO

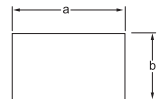

Art. Code	a mm	b mm	g	
8164 7481	390	190	4350	1
Content		7481	10 - 11 - 12 - 13 - 14 - 15 - 16 - 17 - 18 - 19 - 20 - 21 - 22 - 24 - 27 mm	
		7499		



1/3

■ MTS-R/V: Impact Sockets 20 (3/4)



- Zweifarbige MTS-Einlage mit 14-tlg. Satz Kraft-Steckschlüsseln
- Passend für Werkstattwagen RATIO und VARIO, mit Leermod Two-colored MTS inlay with 14 pcs. impact sockets set

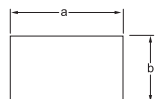

Art. Code	a mm	b mm	g	
8164 7575	390	190	6000	1
Content		7575	24 - 27 - 30 - 32 - 36 mm	
		7581	17 - 19 - 22 - 24 - 27 - 30 mm	
		7582	20 (3/4) - 12.5 (1/2)	
		7599		



1/3

■ MTS-R/V: Pneumatic Tools



- Two-colored MTS inlay with impact wrench and air blow gun
- Suitable for RATIO and VARIO and in combination with empty modules also QUADRO

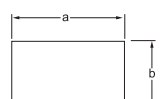

Art. Code	a mm	b mm	g	
8164 1700	390	190	2200	1
Content		7000	1.490 N·m	
		7003	813 N·m	
			7003	300 mm



1/3

■ MTS-R/V: Pliers

- Two-colored MTS inlay with 4 pcs. set of pliers
- Suitable for RATIO and VARIO and in combination with empty modules also QUADRO

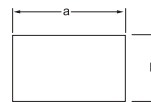

Art. Code	a mm	b mm	g	
8164 1500	390	190	1200	1
8164 1502	390	190	1200	1
Content	0500 180 mm (7")			
	0530 180 mm (7")			
	0565 240 mm			
	0585 205 mm (8")			
8164 1501	390	190	1200	1
8164 1503	390	190	1200	1
Content	0500 180 mm (7")			
	0530 180 mm (7")			
	0565 240 mm			
	0586 205 mm (8")			



8164 1500 / 8164 1502 (VDE)
with straight telephone pliers

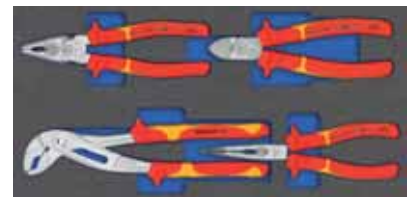

8164 1501 / 8164 1503 (VDE)
with bent telephone pliers

MTS MATADOR
TOOL SYSTEM.

1/3

■ MTS-R/V: Circlip Pliers

- Two-colored MTS inlay with 4 pcs. circlip pliers
- For circlips ø 19 - 60 mm
- Suitable for RATIO and VARIO and in combination with empty modules also QUADRO

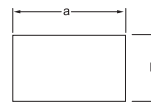

Art. Code	a mm	b mm	g	
8164 1504	390	190	750	1
Content	0578 A2 180 mm			
	0580 A21 165 mm			
	0582 J2 180 mm			
	0584 J21 165 mm			

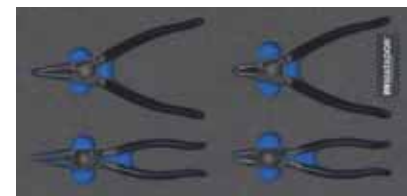

MTS MATADOR
TOOL SYSTEM.

1/3

■ MTS-R/V: Circlip Pliers XL

- Two-colored MTS inlay with 4 pcs. circlip pliers
- For circlips ø 40 - 100 mm
- Suitable for RATIO and VARIO and in combination with empty modules also QUADRO

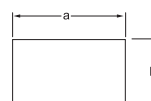

Art. Code	a mm	b mm	g	
8164 1505	390	190	1000	1
Content	0578 A3 225 mm			
	0580 A31 215 mm			
	0582 J3 225 mm			
	0584 J31 210 mm			

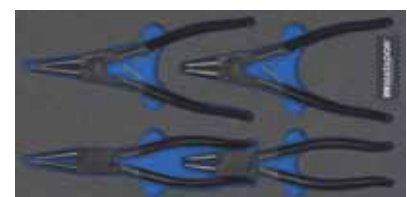

MTS MATADOR
TOOL SYSTEM.

1/3

■ MTS-R/V: Screwdrivers



8164 1616 (VDE)

- Two-colored MTS inlay with 10 pcs. screwdriver set
- Suitable for RATIO and VARIO and in combination with empty modules also QUADRO

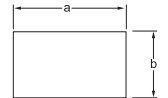

Art. Code	a mm	b mm	g	
8164 1615	390	190	600	1
8164 1616	390	190	600	1

Content	0615/0660	0616	0635	0640	0655	0656	0641
	0,5 x 3 x 100 - 0,8 x 5 x 100 - 1,0 x 5,5 x 125 - 1,2 x 6,5 x 150 mm	VDE: 0,6 x 3,5 x 100 - 0,8 x 4 x 100 - 1,0 x 5,5 x 125 - 1,2 x 6,5 x 150 mm	3 mm	0,8 x 4 x 25 mm	PH 0 - PH 1 - PH 2	VDE: PH 0 - PH 1 - PH 2	PH 1



1/3

■ MTS-R/V: Screwdrivers (TORX®)

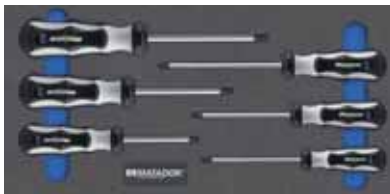

- Two-colored MTS inlay with 6 pcs. screwdriver set
- Suitable for RATIO and VARIO and in combination with empty modules also QUADRO

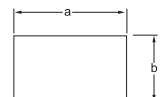

Art. Code	a mm	b mm	g	
8164 1620	390	190	500	1

Content	0620
	T10 x 80 - T15 x 80 - T20 x 90 - T25 x 90 - T30 x 110 - T40 x 120 mm



1/3

■ MTS-R/V: Screwdrivers with wooden handle



- Two-colored MTS inlay with 6 pcs. screwdriver set
- Suitable for RATIO and VARIO and in combination with empty modules also QUADRO

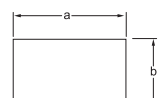

Art. Code	a mm	b mm	g	
8164 1653	390	190	800	1

Content	0652	0653
	1,0 x 5,5 x 100 - 1,2 x 8 x 150 - 2,0 x 12 x 200 mm	PH 1 - PH 2 - PH 3



1/3

■ MTS-R/V: Precision Tools Set

- Two-colored MTS inlay with 17 pcs. set of precision tools
- Suitable for RATIO and VARIO and in combination with empty modules also QUADRO



Art. Code	a mm	b mm	g	
8164 1663	390	190	400	1
Content	<ul style="list-style-type: none"> 0627 4 - 5,5 - 8 mm 0628 PH 1 - PH 2 - PH 3 - PH 4 0661 0,25 x 1,0 x 50 - 0,4 x 2,0 x 50 - 0,5 x 3,0 x 50 mm 0662 PH 00 - PH 0 - PH 1 0663 T5 - T6 - T7 - T8 - T10 - T15 			



MTS MATADOR TOOL SYSTEM.

1/3

■ MTS-R/V: T-Handle Wrenches

- Two-colored MTS inlay with 15 pcs. set of T-Handle wrenches
- Suitable for RATIO and VARIO and in combination with empty modules also QUADRO



Art. Code	a mm	b mm	g	
8164 1441	570	390	1400	1
Content	<ul style="list-style-type: none"> 0445 2 - 3 - 4 - 5 - 6 - 8 - 10 mm 0446 T10 - T15 - T20 - T25 - T27 - T30 - T40 - T45 mm 			

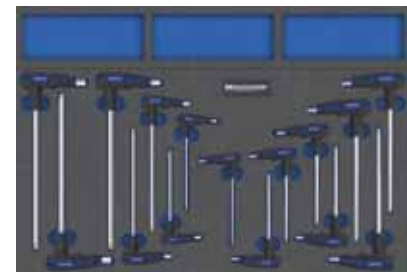

MTS MATADOR TOOL SYSTEM.

3/3

■ MTS-R/V: Files

- Two-colored MTS inlay with 5 pcs. set of files
- Second cut
- Suitable for RATIO and VARIO and in combination with empty modules also QUADRO



Art. Code	a mm	b mm	g	
8164 1775	390	190	800	1
Content	<ul style="list-style-type: none"> 0775 200 mm 			



MTS MATADOR TOOL SYSTEM.

1/3

■ MTS-R/V: Mechanic's Tools Basic



- Two-colored MTS inlay with 11 pcs. set of mechanic's tools
- Suitable for RATIO and VARIO and in combination with empty modules also QUADRO

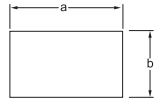

Art. Code	a mm	b mm	g	
8164 1701	390	190	1900	1
Content	<ul style="list-style-type: none"> 0705 500 g 0714 150 mm, 200 mm 0717 120 x 4 x 10 mm 0718 3 - 4 - 5 - 6 mm 0798 3 m 0827 18 mm 0885 			



1/3

■ MTS-R/V: Mechanic's Tools supplement



- Two-colored MTS inlay with 7 pcs. set of mechanic's tools
- Suitable for RATIO and VARIO and in combination with empty modules also QUADRO

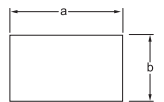

Art. Code	a mm	b mm	g	
8164 1707	390	190	1900	1
Content	<ul style="list-style-type: none"> 0705 500 g 0738 115 x ø 65 mm 0717 120 x 4 x 10 mm 0718 3 - 4 - 5 - 6 mm 			



1/3

■ MTS-R/V: Mechanic's Tools Basic XL



- Two-colored MTS inlay with 25 pcs. set of mechanic's tools
- Suitable for RATIO and VARIO and in combination with empty modules also QUADRO

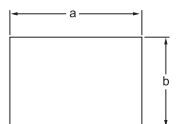

Art. Code	a mm	b mm	g	
8164 1705	570	390	5800	1
Content	<ul style="list-style-type: none"> 0700 ø 22, 35 mm 0702 ø 40 mm 0705 500, 1000 g 0714 125 - 175 - 200 mm 0715 125 - 175 - 200 mm 0716 3 - 4 - 5 - 6 - 8 - 10 mm 0717 120 x 4 x 10 mm 0718 2 - 3 - 4 - 5 - 6 - 8 - 10 mm 			



3/3

■ MTS-R/V: Cutting Tools

- Two-colored MTS inlay with 11 pcs. set of sawing and cutting tools
- Suitable for RATIO and VARIO and in combination with empty modules also QUADRO



Art. Code	a mm	b mm	g	
8164 1786	570	390	3200	1
Content	<ul style="list-style-type: none"> 0588 10"/250 mm 0747 R 0771 M3 - M24 0786 440 mm 0787 250 mm 0820 8 - 24 mm 0828 180 mm 			

MTS MATADOR TOOL SYSTEM.

3/3

■ MTS-R/V: Truck Set

- Two-colored MTS inlay with 19 pcs. set of truck tools
- Suitable for RATIO and VARIO and in combination with empty modules also QUADRO



Art. Code	a mm	b mm	g	
8164 1708	570	390	5800	1
Content	<ul style="list-style-type: none"> 0705 750 g 0700 ø 40 mm 0100 24 x 27 - 25 x 28 - 30 x 32 mm 0185 24 - 27 - 30 - 32 mm 0200 24 x 27 - 25 x 28 - 30 x 32 mm 0600 1,2 - 1,6 - 2,0 mm 0650 PH 2 - PH 3 - PH 4 			

MTS MATADOR TOOL SYSTEM.

3/3

■ MTS-R/V: Measuring instruments



- Two-colored MTS inlay with 11 pcs. set of measuring tools
- With torque wrench ALLROUND, accuracy $\pm 3\%$, 20 - 200 N-m
- Suitable for RATIO and VARIO trolleys

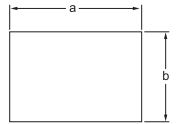

Art. Code	a mm	b mm	g	
8164 1798	570	390	3000	1
Content	<ul style="list-style-type: none"> 0760 20 x 0,05 - 1,00 mm 0764 52 x 0,25 - 6,00 mm 0798 3 m 0798 200 x 22 x 6 mm 0798 300 x 15 x 0,5 - 300 x 30 x 1,0 mm 0798 200 x 130 mm 0798 150 mm 0798 400 mm 0799 250 mm 6176 20 - 200 N-m 			

MTS MATADOR TOOL SYSTEM.

3/3

■ MTS-R/V: Torque tools 9 x 12



8164 6176



8164 6190

- Set with the most important insert tools with rectangular cavity in 9 x 12 mm
- With torque wrench
- With fine teeth insert reversible ratchet

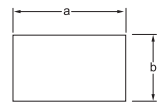

Art. Code	a mm	b mm	g	
8164 6176	390	190	1400	1
Content	<ul style="list-style-type: none"> 6185 10 - 100 N-m 6186 6190 8 - 10 - 11 - 12 - 13 - 16 - 17 - 19 mm 6191 8 - 10 - 11 - 12 - 13 - 16 - 17 - 19 mm 			
8164 6190	390	190	1400	1
Content	<ul style="list-style-type: none"> 6186 6190 8 - 10 - 11 - 12 - 13 - 16 - 17 - 19 mm 6191 8 - 10 - 11 - 12 - 13 - 16 - 17 - 19 mm 			

MTS MATADOR TOOL SYSTEM.

1/3

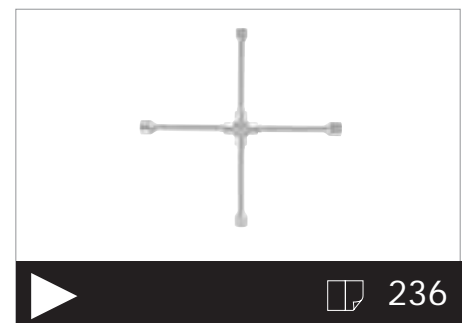
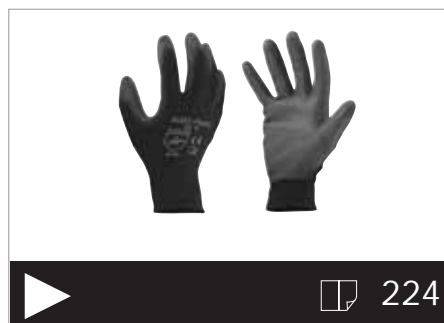
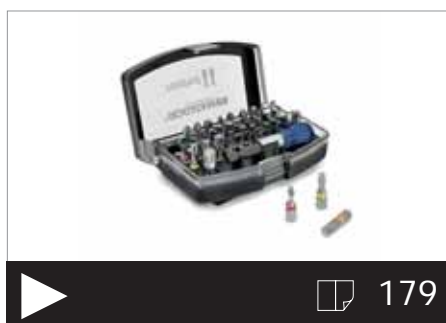

■ MTS-R/V: Empty Modules

- For 1/3-RATIO module in RATIO/VARIO

R V

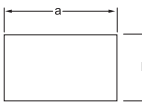

Art. Code	a mm	b mm	g	
8164 0095	390	190	18	1

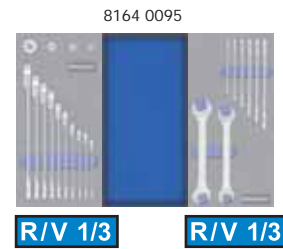

■ MTS-R/V: Empty Modules

- For 3/3-RATIO module in RATIO/VARIO

R V



Art. Code	a mm	b mm	g	
8164 0096	570	50	18	1
8164 0097	570	50	18	1
8164 9998	VARIO	390	12	1

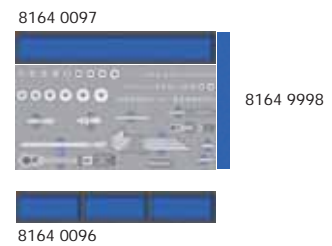

■ MTS Self Cutting Module

- Two-colored MTS inlay for cutting of individual tool module

Q R V

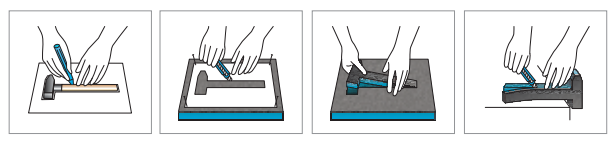
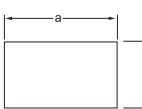
Art. Code	a mm	b mm	g	
8164 9999	570	390	120	1

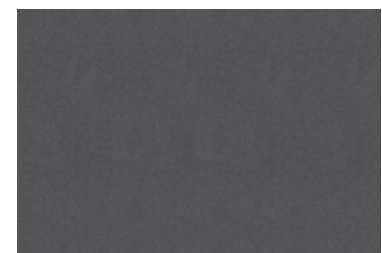

MTS MATADOR
TOOL SYSTEM.

Do you need assistance with your configuration?

Please contact us - we will be pleased to assist you!

Phone +49 (0) 2191 - 9743 - 0
Fax +49 (0) 2191 - 9743 - 44

E-Mail info@matador.de
Internet www.matador.de



■ Tool Assortment smartyCAR

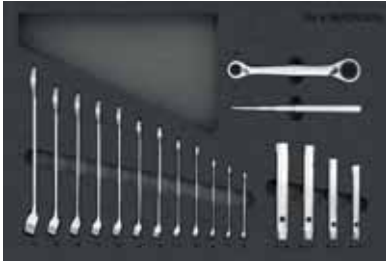

8164 5185



8164 8145



8164 2615



Including removable smartyBOX S1.

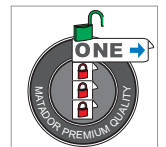

The tool assortment smartyCAR is our special model with 150 tools „Best of MATADOR“. High quality tools for all kind of simple repair jobs and the entry level into the tool world of MATADOR.

It contains:

- Combination- and 4 in 1 ring ratchet spanner 6 - 22 mm
- Tubular box spanners with tommy bar
- Socket set with 6.3 mm (1/4") and 12.5 mm (1/2") drive, sockets 4 - 32 mm
- Screwdriver sockets for slotted, PH, hex and TORX® screws
- Pliers set with **3KsoftGrip** handles
- Screwdriver set with 2-component handles for slotted and PH screws
- Mechanic's set with the most important striking tools
- Cutting and measuring tools

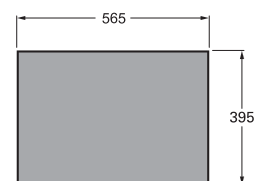
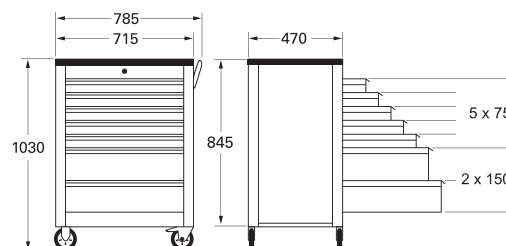

Art. Code

8163 9150 **150** **MM** **6** RATIO (7 drawers) with tool assortment smartyCAR, 150 pcs



kg

-- 1

With 150 selected tools.

■ Tool Assortment UNIVERSAL

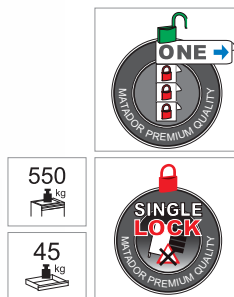

8164 1100 8164 1185 8164 4671



8164 1411



8164 1500 8164 1615 8164 1707

32 pcs torsion bitset included.

25 pcs twist drill assortment HSS-R included.



The tool assortment **UNIVERSAL** is the basic assortment with the most important tools for general repair jobs. High quality tools for home users and DIYers in the tool world of MATADOR.

It contains:

- Combination spanners and double open ended spanners 6 - 22 mm
- Nut Drivers with T-handle 8 - 10 - 13 mm
- Socket set with 6.3 mm (1/4") and 12.5 mm (1/2") drive, sockets 4 - 32 mm
- Screwdriver sockets for slotted, PH, hex and TORX® screws E4 - E11, T8 - T40
- Pliers set with **3KsoftGrip** handles
- Screwdriver set with 2-component handles for slotted and PH screws
- Mechanic's set with the most important striking tools
- 31-pc bitset and 25-pc drill assortment included

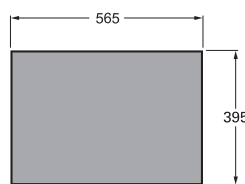
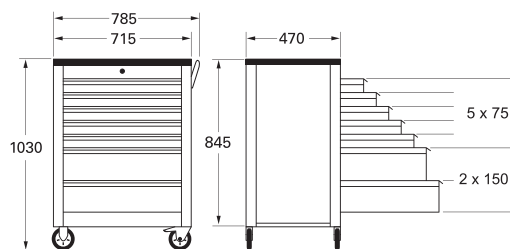

MTS MATADOR TOOL SYSTEM.

Art. Code	170	MM	6	Description	kg	1
8178 9550	170	MM	6	Tool assortment UNIVERSAL, 170 pcs	--	1
8163 9550	170	MM	6	RATIO (7 drawers) with tool assortment UNIVERSAL, 170 pcs	--	1

**All you need.
The expert's choice.**

■ Tool Assortment INDUSTRIAL

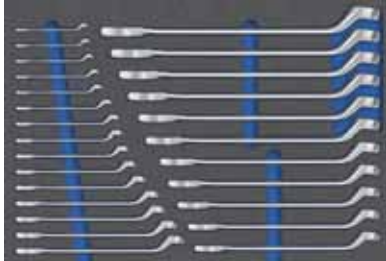

8164 3190



8164 1201

8164 1401

8164 4078



8164 4092

8164 1775

8164 4671



8164 1500

8164 1615

8164 1653



8164 1705



The tool assortment **INDUSTRIAL** was designed by experts especially for industrial maintenance and assembly jobs. All tools for the experienced mechanic are included.

It contains:

- Combination spanners, deep offset 6 - 32 mm
- Socket set with 6.3 mm (1/4") and 12.5 mm (1/2") drive, sockets 4 - 32 mm
- Comprehensive assortment of screwdriver sockets for slotted, PH, hex and TORX® screws E4 - E11, T8 - T40
- Pliers set with **3KsoftGrip** handles
- Screwdriver set with 2-component handles for slotted, PH and TORX® screws and additional screwdriver set with striking cap
- Large mechanic's set with numerous striking tools
- and many more tools

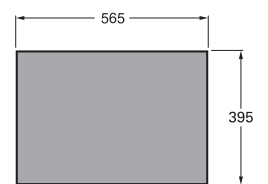
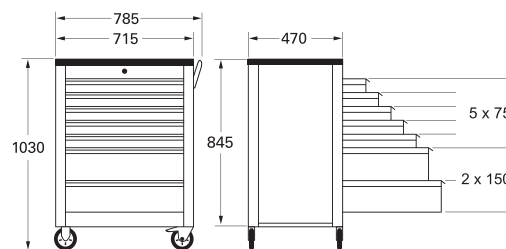

Art. Code



kg

8178 9570 Tool assortment INDUSTRIAL, 242 pcs

-- 1

8163 9570 RATIO (7 drawers) with tool assortment INDUSTRIAL, 242 pcs

-- 1

■ Tool Assortment **AUTOMOTIVE**

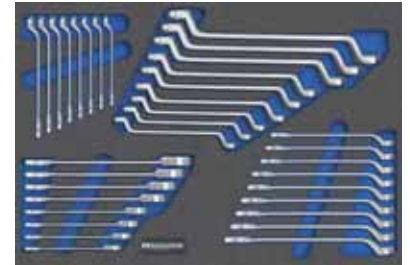
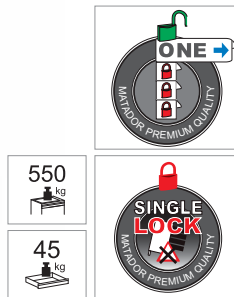

8164 1195

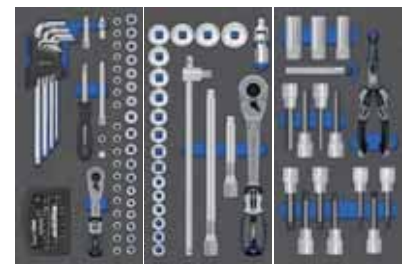

8164 1201

8164 1401

8164 1481



8164 1500

8164 1615

8164 1701

The tool assortment **AUTOMOTIVE** is the basic assortment for any kind of car repair. 3 fully equipped drawers with high quality tools, e.g. **ratchet spanners** and the most important **tools for changing spark plugs** including a **high quality inspection LED lamp**.

It contains:

- Combination spanners and double ended ring spanners 6 - 23 mm
- Combination ratchet spanners 8 - 19 mm
- Socket set with 6.3 mm (1/4") and 12.5 mm (1/2") drive, sockets 4 - 32 mm
- Screwdriver sockets for slotted, PH, hex, RIBE and TORX® screws
- Pliers set with **3KsoftGrip** handles
- Screwdriver set with 2-component handles for slotted and PH screws
- and many more tools

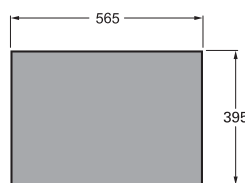
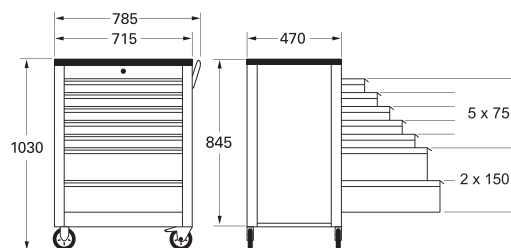

MTS MATADOR TOOL SYSTEM.

Art. Code	kg	
8163 9560 RATIO (7 drawers) with tool assortment AUTOMOTIVE , 182 pcs	--	1

Selected tool assortments for automotive repair.

■ Tool Assortment TRUCK

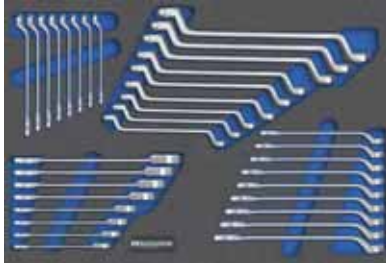

8164 1195



8164 1201

8164 1401

8164 1481



8164 1500

8164 1615

8164 1701

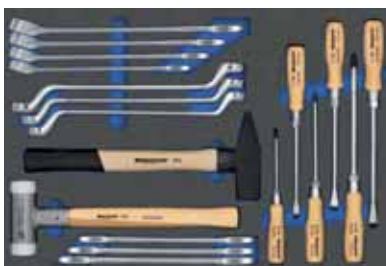

8164 1708

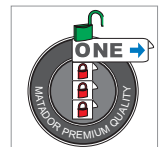

The tool assortment **TRUCK** contains the **tool assortment AUTOMOTIVE** and additionally a **19-pc module with basic tools for the repair of commercial vehicles**, e.g. spanners up to 32 mm and classical wooden screwdrivers with striking cap.

It contains:

- Combination spanners and double ended ring spanners 6 - 23 mm
- Combination ratchet spanners 8 - 19 mm
- Socket set with 6.3 mm (1/4") and 12.5 mm (1/2") drive, sockets 4 - 32 mm
- Screwdriver sockets for slotted, PH, hex, RIBE and TORX[®] screws
- Pliers set with **3KsoftGrip** handles
- Screwdriver set with 2-component handles for slotted and PH screws
- and many more tools

MTS MATADOR TOOL SYSTEM.

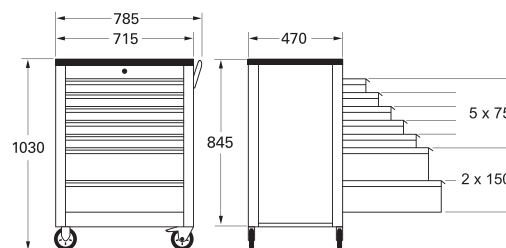

Selected tool assortments for automotive repair.



Art. Code

8163 9561 **201** **MM** **6** RATIO (7 drawers) with tool assortment TRUCK, 201 pcs



kg

-- 1

■ Tool Assortment **AUTOMOTIVE PRO**

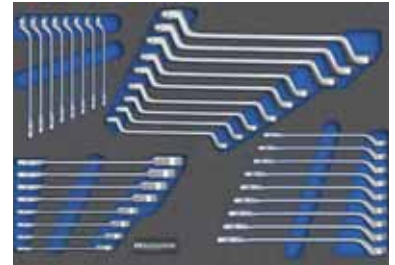
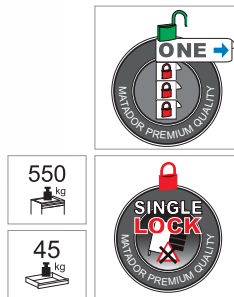

8164 1195

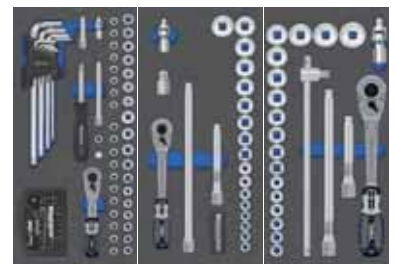

8164 1201

8164 1301

8164 1401

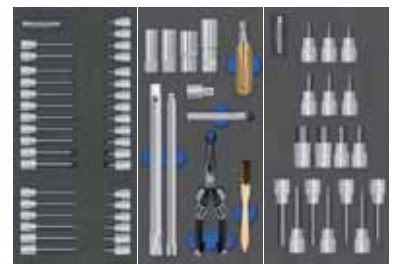

8164 3078

8164 3081

8164 4078

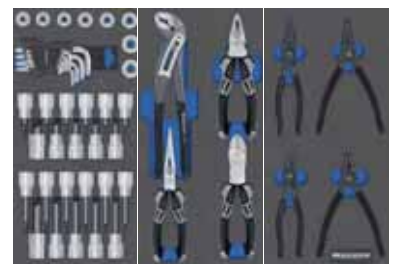

8164 4092

8164 1500

8164 1504

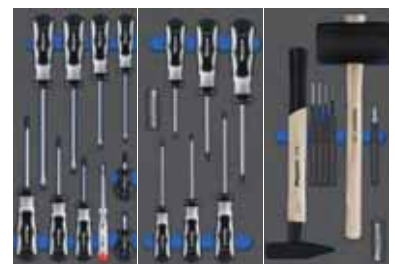

8164 1615

8164 1620

8164 1707

The tool assortment **AUTOMOTIVE PRO** is a comprehensive selection of tools for your workshop (as recommended by Ford and Jaguar Land Rover) and has been compiled by many experts.

It contains:

- Socket set with 6.3 mm (1/4"), 10 mm (3/8") and 12.5 mm (1/2") drive, all sockets from 4 - 32 mm
- Comprehensive assortment of screwdriver sockets for slotted, PH, hex and TORX® screws E4 - E24, T8 - T55
- Tool set for spark plugs
- Plier set with **3KsoftGrip** handles
- Circlip plier set
- Comprehensive screwdriver set with 2-component handles for slotted, PH and TORX® screws
- Mechanic's set with the most important striking tools
- and many more tools

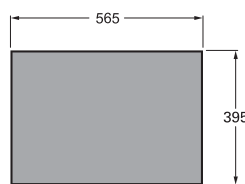
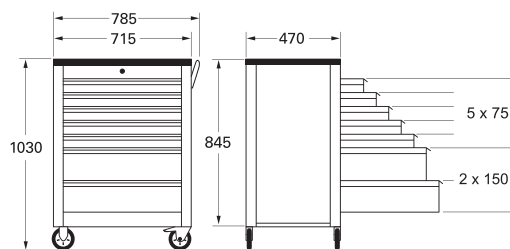

Art. Code	Weight	Dimensions	Weight	Quantity
8178 9580	279 kg	MM 6	Tool assortment AUTOMOTIVE PRO , 297 pcs	1
8163 9580	279 kg	MM 6	RATIO (7 drawers) with tool assortment AUTOMOTIVE PRO , 297 pcs	1



■ Tool Assortment FORD

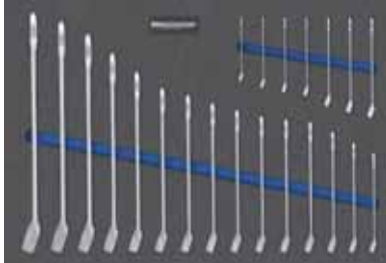

8164 3185

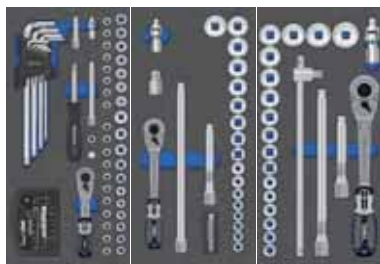

8164 1201 8164 1301 8164 1401

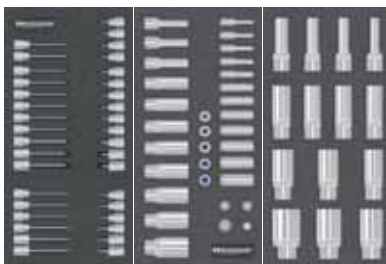

8164 3078 8164 3082 8164 4081

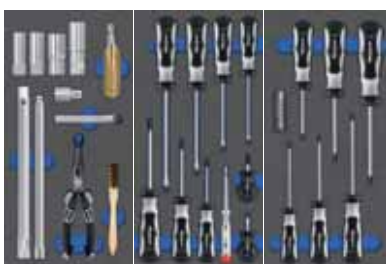

8164 3081 8164 1615 8164 1620

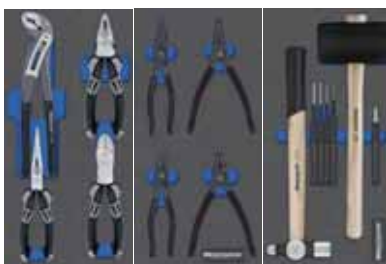

8164 1500 8164 1504 8164 1706

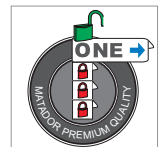

Tool trolley **RATIO** with 7 drawers, including **275 high quality tools** in 5 drawers with **2-coloured MTS modules** („See what is missing“), e.g. with:

- Combination Spanners angled DIN 3113 A 6 - 34 mm
- Socket set with 6,3 mm (1/4"), 10 mm (3/8") and 12,5 mm (1/2") drive, sockets 4 - 32 mm
- **Premium Z 90** ratchets with 90 teeth for only 4° angle, 50% more torque than DIN standards
- Deep Sockets with 10 mm (3/8") and 12,5 mm (1/2") drive, 4 - 32 mm
- Screwdriver Sockets for slotted, PH and hex screws (4 - 10 mm), TORX® screws E4 - E14 und T8 - T55 (from T15 each in short and long type)
- Spark Plug Tool Set
- 16 pc. screwdrivers Set, also with TORX®
- 4 pc. set of pliers with 3 component pliers
- 4 pc. set of Circlip Pliers
- Mechanic's Tools Kit

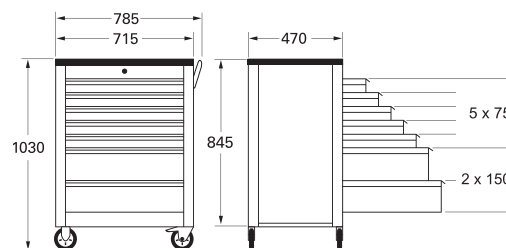

Art. Code

8163 9148 RATIO (7 drawers) with tool assortment FORD, 238 pcs



kg

-- 1

■ Tool Assortment MERCEDES-BENZ

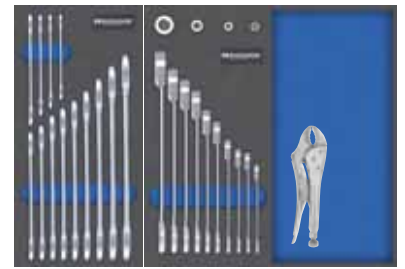
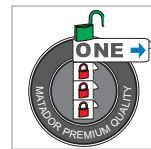

8164 3100

8164 1183

8164 0095

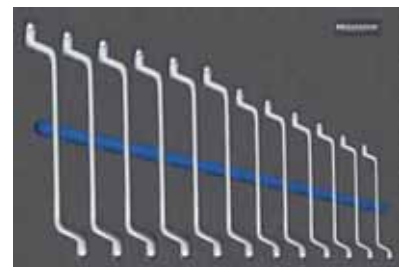

8164 1200

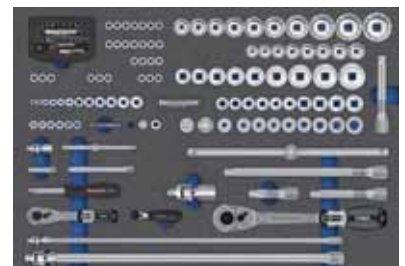

8164 1214



8164 1492

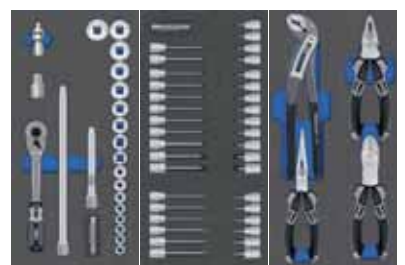

8164 1301

8164 3078

8164 1500

Comprehensive tool kit with **413 premium tools** by MATADOR especially for Mercedes-Benz car workshops. **The best or nothing...**

Based on the **MB standard tool kit** and supplemented by all important automotive tools, this new universal kit covers all central maintenance work.

Including:

- **Oil filter socket 36 mm MB**
(similar W 103 589 02 09 00)
- **Shock absorber tools MB 24 pcs in a plastic case**
(similar W 001 589 03 16 00)



Art. Code	413	MM	6		kg	
8178 9590	413	MM	6	Tool assortment MERCEDES-BENZ, 413 pcs	--	1
8163 9590	413	MM	6	RATIO (8 drawers) with tool assortment MERCEDES-BENZ, 413 pcs	--	1



8164 1800



8164 1710

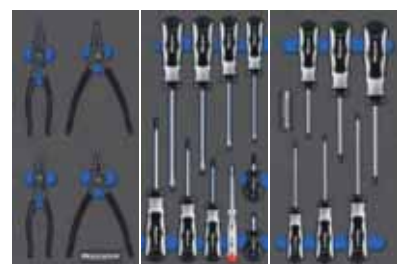

8164 1504

8164 1615

8164 1620

MTS unlimited edition.
350 high quality tools. 8 modules. That's it.



MTS

unlimited edition

Focusing on the essentials.



All inclusive.

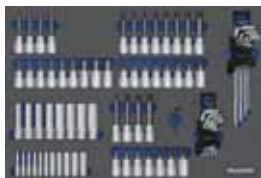
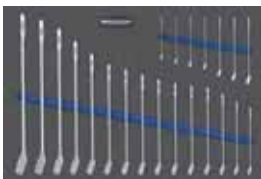

MTS unlimited edition: 8 modules with 350 high quality tools.

Additional modules for automotive repair.

Which tools do you need?

It depends... Your tasks change.

Do you really want to spend your time looking for the right tools for your latest challenge? Do your new tools fit into the tool modules and tool storage system you already use? Probably not.

When you check the market you will find almost uncountable offers of fully equipped tool trolleys - but **what do you really need?**

Save your time and keep an overview because we have a better idea:

We set up a **comprehensive database** including all equipped tool trolleys that we have ever supplied to **BMW, Ford, Jaguar, Land Rover, Mercedes-Benz, Volkswagen** and other customers, and we broke them down to the single tool.

Additionally, we included important **OEM specifications - like Volkswagen VAS 275 001** - and took the tool trolley range of other tool manufacturers into consideration. The unsurprising result:

Around **88%** of the tools listed can be found in any specification because these tools are needed in every workshop.

We added another **10%** of tools that make sense and give you enough scope

for future tasks. So you do not need to look for further additions again.

What came out is our **"MTS unlimited edition" with 350 tools that cover 98% of all application fields.** It's a safe bet.

For the remaining 2% we saved you lots of time.

Make something out of it!

For automotive repairs we added two modules with a comprehensive 10 (3/8) socket set and another module for car body work.



■ MTS-R/V: Combination Spanner Set

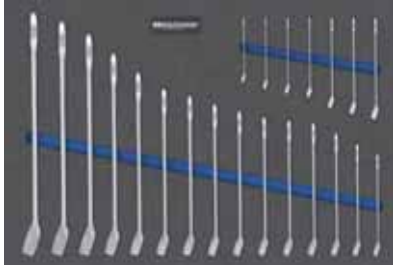

- Two-colored MTS inlay with 22 pcs set of combination spanners
- Suitable for RATIO and VARIO and in combination with empty modules also QUADRO

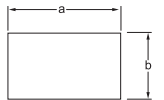

MTS
unlimited edition

3/3

Art. Code	a mm	b mm	g	
8164 3185	570	390	2200	1
Content	0185 6 - 22, 24, 27, 30, 32, 34 mm			

■ MTS-R/V: Combination Ratchet- and Double Ended Ring Spanner Set

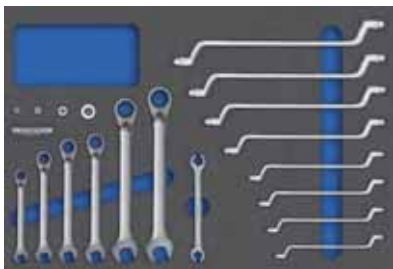

- Two-colored MTS inlay with 19 pcs set of combination ratchet spanners and double ended ring spanners with ratchet adaptors
- With open flare nut ring spanners
- Suitable for RATIO and VARIO and in combination with empty modules also QUADRO

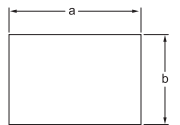

MTS
unlimited edition

3/3

Art. Code	a mm	b mm	g	
8164 3189	570	390	2080	1
Content	0189 8, 10, 12, 13, 17, 19 mm + Knarrenadapter			
	0200 6 x 7 - 20 x 22 mm			
	0250 Bremseinstellschlüssel 10 x 11 mm			

■ MTS-R/V: Mechanic's Tool Set



- Two-colored MTS inlay with 19 pcs set of mechanic tools
- Suitable for RATIO and VARIO and in combination with empty modules also QUADRO

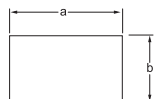

MTS
unlimited edition

3/3

Art. Code	a mm	b mm	g	
8164 1710	570	390	3200	1
Content	0705 400 g			
	0702 ∅40 mm			
	0714 150 mm, 200 mm			
	0716 4 mm, 6 mm			
	0717 120 x 4 x 10 mm			
	0718 3 - 4 - 5 - 6 - 8 mm			
	0775 200 mm			
	0798 5 m			
	0828 170 mm			
	0843 210 mm			

■ MTS-R/V: Socket Set



- Two-colored MTS inlay with 145 pcs set of sockets
- Suitable for RATIO and VARIO and in combination with empty modules also QUADRO

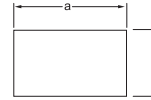

Art. Code		a mm	b mm	g	
8164 1214	MM	570	390	8143	1
Content	2061				
	2062				
	2064 115 mm				
	2065 50, 100 mm				
	2068				
	2073 150 mm				
	2074 500 mm				
	2075 4 - 5 - 5,5 - 6 - 7 - 8 - 9 - 10 - 11 - 12 - 13 - 14 mm				
	2076 4 - 5,5 - 7 x 32 mm				
	2077 PH 1 - PH 2 - PH3				
	2077 PZ 1 - PZ 2 - PZ3				
	2078 3 - 4 - 5 - 6 - 8 - 10 x 32 mm				
	2083 6,3 (1/4) - 10 (3/8)				
	2084 6,3 (1/4) - 6,3 (1/4) Bit				
	2085 6,3(1/4) X 6,3(1/4)				
	2090 E4 - E5 - E6 - E7 - E8 - E10				
	2092 T6 - T7 - T8 - T9 - T10 - T15 - T20 - T25 - T27 - T30 - T40 x 32 mm				
	4061				
	4064 300 mm				
	4065 75, 125, 250 mm				
	4066 125 mm				
	4074 300 mm				
	4068				
	4075 8 - 9 - 10 - 11 - 12 - 13 - 14 - 15 - 16 - 17 - 18 - 19 - 20 - 21 - 22 - 23 - 24 - 27 - 30 - 32 - 34 mm				
	4082 12,5(1/2) - 10(3/8)				
	4083 12,5(1/2) - 20(3/4)				
	4084 12,5(1/2) - 6,3(1/4) Bit				
	4090 E10 - E12 - E14 - E16 - E18 - E20 - E22 - E24				
	7052 Bitbox 32-tlg.				

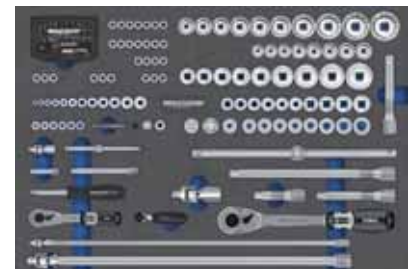

MTS
unlimited edition

3/3

■ MTS-R/V: Screwdriver Sockets / Hex Key Set



- Two-colored MTS inlay with 78 pcs set of screwdriver sockets and hex keys
- Suitable for RATIO and VARIO and in combination with empty modules also QUADRO

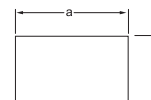

Art. Code		a mm	b mm	g	
8164 1492		570	390	6274	1
Content	0442 1,5 - 10 mm				
	0443 T9 - T50				
	2081 4 - 5 - 6 - 7 - 8 - 9 - 10 - 11 - 12 - 13 - 14 mm				
	4078 5 - 6 - 7 - 8 - 10 - 12 - 14 - 17 - 19 x 62 mm, 6 - 7 - 8 - 10 x 100 mm				
	4079 M5 - M6 - M8 - M10 - M12 - M14 - M16 x 62 mm, M8 - M10 - M12 - M14 x 100 mm				
	4081 10 - 11 - 12 - 13 - 14 - 15 - 17 - 19 mm				
	4092 T25 x 62 - T27 x 62 - T30 x 62 - T40 x 62 - T45 x 62 - T50 x 62 - T55 x 62 - T60 x 62 - T25 x 100 - T27 x 100 - T30 x 100 - T40 x 100 - T45 x 100 - T50 x 100 - T55 x 100 - T60 x 100 mm				



MTS
unlimited edition

3/3

■ MTS-R/V: Plier Set



- Two-colored MTS inlay with 9 pcs set of pliers
- Suitable for RATIO and VARIO and in combination with empty modules also QUADRO

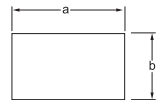

Art. Code	a mm	b mm	g	
8164 1510	570	390	2130	1
Content	0500 165 mm (6.1/2")			
	0530 180 mm (7")			
	0565 240 mm			
	0585 170 mm (6.3/4")			
	0578 A2			
	0580 A21			
	0582 J2			
	0584 J21			
	0588 250 mm (10")			

MTS
unlimited edition

3/3

■ MTS-R/V: Automotive Tool Set



- Two-colored MTS inlay with 24 pcs set of automotive tools
- Suitable for RATIO and VARIO and in combination with empty modules also QUADRO

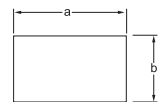

Art. Code	a mm	b mm	g	
8164 1800	570	390	5424	1
Content	0568 205 mm			
	0671 8, 10, 13 x 230 mm			
	0754 500 mm			
	0760 20 x 0,05 - 1,00 mm			
	0784 1000 g			
	0840 250 mm			
	0842 160 mm			
	0852 225 mm			
	4081 16 - 18 - 20,8 mm			
	5064 20 (3/4") 500 mm			
	5082 20 (3/4") - 12,5 (1/2")			
	7575 32, 36 mm			
	7481 17, 19, 21 mm			
	7599			
	0795 285 - 870 mm			

MTS
unlimited edition

3/3

■ MTS-R/V: Screwdriver Set



- Two-colored MTS inlay with 34 pcs set of screwdrivers
- Suitable for RATIO and VARIO and in combination with empty modules also QUADRO

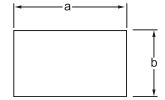

Art. Code		↔	↑	⚖	📦
		a mm	b mm	g	
8164 1600		570	390	1639	1
Content	0615/0660 3 x 100 - 4 x 75 - 5,5 x 125 - 6,5 x 150 - 8 x 175 - 10 x 200 - 12 x 250mm 0640 6,5 x 25 mm 0620 T6 x 75 - T7 x 75 - T8 x 75 - T9 x 70 - T10 x 80 - T15 x 80 - T20 x 90 - T25 x 100 - T27 x 115 - T30 x 115 mm 0655 PH 1 - PH 2 - PH 3 0641 PH 2 0661 0,25 x 1,0 x 50 - 0,4 x 2,0 x 50 - 0,5 x 3,0 x 50 mm 0662 PH 00 - PH 0 - PH 1 0663 T5 - T6 - T7 - T8 - T10 - T1				

MTS
unlimited edition

3/3

■ MTS-R/V: Additional modules

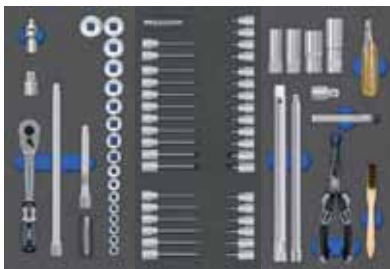

- Two-colored MTS inlay with 69 pcs set of additional automotive tools
- Suitable for RATIO and VARIO and in combination with empty modules also QUADRO

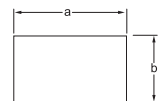

Art. Code		↔	↑	⚖	📦
		a mm	b mm	g	
8164 1310		570	390	--	1
Content	8164 1301 8164 3078 8164 3081				

MTS
unlimited edition

3/3

■ MTS-R/V: Additional modules



- Two-colored MTS inlay with 7 pcs set of additional automotive tools
- Suitable for RATIO and VARIO and in combination with empty modules also QUADRO

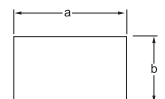

Art. Code		↔	↑	⚖	📦
		a mm	b mm	g	
8164 1745		570	390	--	1
Content	0705 1000 g 0738 115 x 65 mm 0747 L, R 0788 150 mm 0846 240 mm 0587 195 mm				

MTS
unlimited edition

3/3

■ Tool Assortment UNLIMITED EDITION

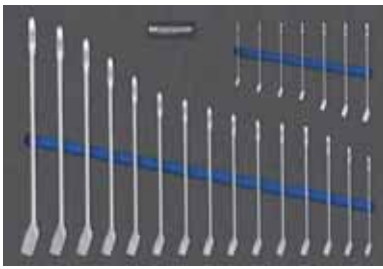

8164 3185

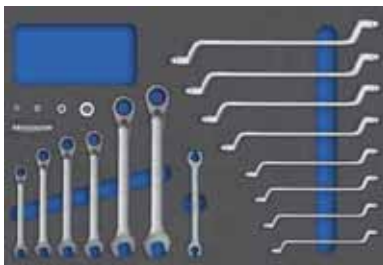

8164 3189

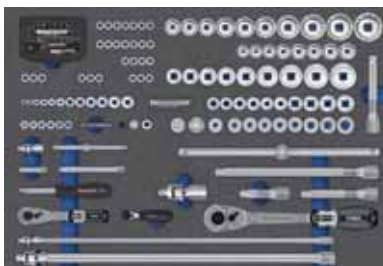

8164 1214



8164 1492



8164 1510



8164 1600



MTS
unlimited edition

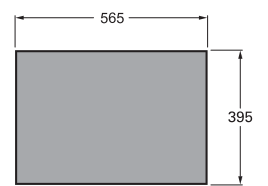
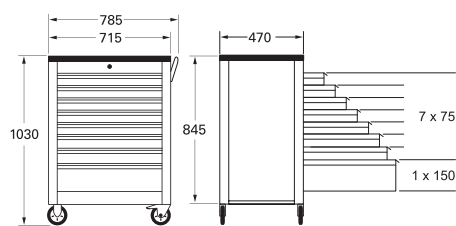

Art. Code

kg

8178 9350 Tool assortment MTS unlimited edition, 350 pcs

-- 1

8163 9350 RATIO 8D with tool assortment MTS unlimited edition, 350 pcs

-- 1



8164 1800



8164 1710

■ Tool assortment VARIO „175“



750 kg

35 kg

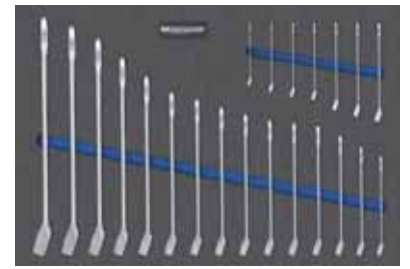

8164 3185

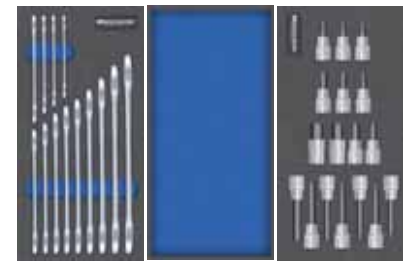

8164 3100

8164 0095

8164 4078



8164 1411



8164 1500

8164 1615

8164 1701

- Workshop trolley VARIO with 7 drawers
- Body made of high-quality steel sheet 1.75 mm reinforced frame
- ABS worktop with compartments for small parts, screwdriver holders and 2 handles
- Premium powder coating in silver-aluminium / black (RAL 9006 / 9005)
- Drawers: 2 x 50 mm, 3 x 100 mm, 1 x 200 mm, all drawers 100% extendable, loadable with 35 kg each
- 3-level locking system: central locking, single-locked drawers, mechanical interlock („one at-a-time“ locking system)
- Ball-bearing precision slides

- Side and back panels with square perforation for assembly of accessories
- With 175 high quality tools from MATADOR in 3 drawers with two-colored MTS modules e.g.:
- Combination Spanners, angled, DIN 3113 A 6 - 34 mm
- Socket Set with 6,3 mm (1/4") and 12,5 mm (1/2") drive, sockets 4 - 32 mm
- Screwdriver Sockets for slotted, PH and hex screws (e.g. 3 - 17 mm, short and long type) and TORX® screws E4 - E11, T8 - T40
- Set of pliers
- Set of screwdrivers
- Mechanic's Tools Kit
- etc.

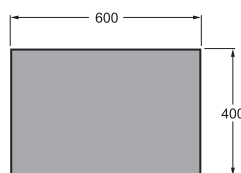
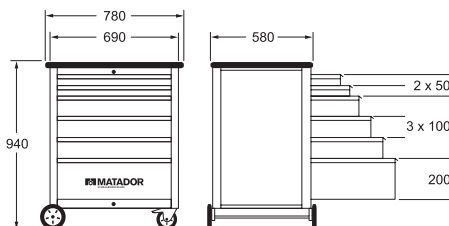

25-pc twist drill assortment HSS-R included.



Rubber Mallet included.



Tyre lever included.



Art. Code

8164 0175 **175** **MM** **6** VARIO 7D with tool assortment, 175 pcs



kg

80 1



Tool Assortments

Be a MATADOR.



Content

Tool Assortments.

Page Article group

smartyBOX

312 smartyBOX empty

314 smartyBOX S0 Compact

315 smartyBOX S0 Basic

316 smartyBOX S1

317 smartyBOX S2

317 smartyBOX S3

318 smartyBOX S4

319 smartyBOX S5

320 smartyBOX L1

321 smartyBOX L2

Tool Assortments in Cases

322 Tool case Automotive

323 Tool case Black Box

324 Tool case Cow

324 Tool case Soft

325 Tool case ABS

326 Tool case CADDY

327 Tool case CADDY with Tool
Assortment UNIVERSAL XL

328 Tool case CADDY with Tool
Assortment Allround

330 Tool case STEEL 3

330 Tool case STEEL 3 with Tool
Assortment VDE

331 Tool case STEEL 5

331 Tool case STEEL 5 with Tool
Assortment UNIVERSAL



Smart toolboxes.
Intelligent solutions for mobile use.



Our smallest.
Compact in pocket size.



■ L-BOXX -Mini, empty

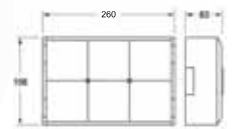

Art. Code	g	
8145 0020	590	1



Stackable and can be clicked onto each other for easy transportation.





The new smartyBOX.
The world's smallest workshop.

■ **i-BOXX®**, empty

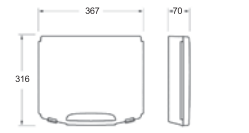

Art. Code	g	
8145 0030	880	1

Perfect order
at every location.



Space for small parts.

■ **L-BOXX®118**, empty



Art. Code	g	
8145 0035	1750	1

■ **L-BOXX®152**, empty

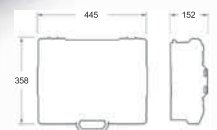

Art. Code	g	
8145 0040	1870	1



Die smartyBOX S0 compact. Our smallest.

Compact in pocket size.

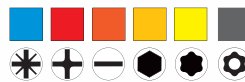
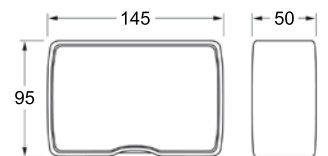

MFS MATADOR FOAM SYSTEM.

■ smartyBOX S0 compact



- Handy size of just 145 x 95 mm fits in any drawer, even in your desk or under the motor-cycle seat
- Including the new MATADOR Z90 1/4" reversible ratchet with 90 teeth for the smallest gaps
- 30 standard bits of high-alloy S2 material (25 mm)
- 6 extra-long screwdriver blades (75 mm)
- With color guide system for faster identification
- Sockets with double smart drive profile
- Everything is fit securely into MFS soft foam inlays and survives even the hardest fall



Art. Code	a mm	h mm	b mm	g	
2155 0001	145	50	95	850	1

Content	Art. Code	Description
	2061	Reversible Ratchet
	2065	Extension 50 mm
	2075	6 - 7 - 8 - 9 - 10 - 11 - 13 mm
	2084	Bit-Adapter F
	7040	Drill Adapter for Bits
	7026	Bits 3 - 3.5 - 4.5 - 5.5 - 6.5 x 25 mm Screwdriver-Bits long type: 4 - 6 x 75 mm
	7027	Bits PH 0 - PH 1 - PH 2 - PH2 - PH 3 x 25 mm Screwdriver-Bits long type: PH 1 - PH 2 x 75 mm
	7027	Bits PZ 0 - PZ 1 - PZ 2 - PZ2 - PZ 3 x 25 mm
	7028	Bits 3 - 4 - 5 - 6 x 25 mm
	7033	Bits T6 - T7 - T8 - T9 - T10 - T15 - T25 - T27 - T30 T40 x 25 mm Screwdriver-Bits long type: T25 - T30 x 75 mm

The smartyBOX S0 Basic.

The low budget universal box.

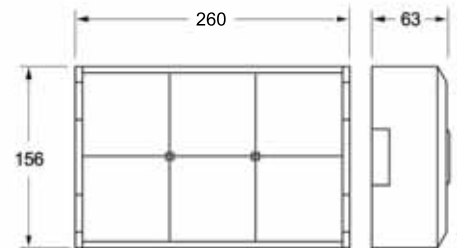

Compact in size:
W 260 x D 156 x H 63 mm.



Stackable and can be clicked onto each other for easy transportation.

■ smartyBOX S0 Basic



- Including the new MATADOR Z90 1/4" reversible ratchet with 90 teeth for the smallest gaps
- Comes with everything needed for screw tasks from 4 - 14 mm
- With innovative spinner handle that can be used as a multiscrewdriver and extends a total length of 370 mm
- With color guide system for faster identification
- Sockets with double smart drive profile
- Everything is fit securely into MFS soft foam inlays and survives even the hardest fall

Art. Code	b mm	h mm	t mm	g
8145 2110	260	63	156	1100

Content	Art. Code	Description
	2061	Reversible Ratchet
	2065	Extensions + 50 - 100 mm
	2068	Universal Joint
	2073	Multi Component Spinner Handle
	2075	4 - 4,5 - 5 - 5,5 - 6 - 7 - 8 - 9 - 10 - 11 - 12 - 13 - 14 mm
	2084	Bit-Adapter F
	2084	Bit-Adapter M
	7040	Drill Adapter for Bits
	7026	Bits 3 - 3.5 - 4.5 - 5.5 - 6.5 x 25 mm
	7027	Bits PH 0 - PH 1 - PH 2 - PH 2 - PH 3 x 25 mm
	7027	Bits PZ 0 - PZ 1 - PZ 2 - PZ 2 - PZ 3 x 25 mm
	7028	Bits 3 - 4 - 5 - 6 x 25 mm
	7033	Bits T6 - T7 - T8 - T9 - T10 - T15 - T20 - T25 - T27 - T30 - T40 x 25 mm
	8191	Lanyard with snap hook for scuring the reversible ratchet



The smartyBOX S1.

The world's smallest workshop.

S1

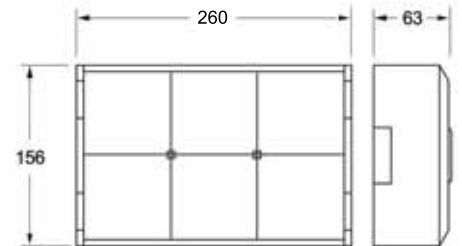

Compact in size:
W 260 x D 156 x H 63 mm.



Stackable and can be clicked onto each other for easy transportation.

■ smartyBOX S1

1/4 61

- Including the new MATADOR Z90 1/4" reversible ratchet with 90 teeth for the smallest gaps
- Comes with everything needed for screw tasks from 4 - 14 mm
- With innovative spinner handle that can be used as a multiscrewdriver and extends a total length of 420 mm
- Including combination pliers with integrated ring spanner for countering
- With color guide system for faster identification
- Sockets with double smart drive profile
- Everything is fit securely into MFS soft foam inlays and survives even the hardest fall



Art. Code	b mm	h mm	t mm	g
8145 2115	260	63	156	1300
Content 0500 3C Combination Pliers 160 mm 0500 Retaining Clip for Combination Pliers 2061 Reversible Ratchet 2065 Extensions + 50 - 100 mm 2068 Universal Joint 2073 Multi Component Spinner Handle 2075 4 - 4.5 - 5 - 5.5 - 6 - 7 - 8 - 9 - 10 - 11 - 12 - 13 - 14 mm 2084 Bit-Adapter F 2084 Bit-Adapter M 7040 Drill Adapter for Bits 7026 Bits 3 - 3.5 - 4.5 - 5.5 - 6.5 x 25 mm Screwdriver-Bits long type: 4 - 6 x 75 mm 7027 Bits PH 0 - PH 1 - PH 2 - PH 2 - PH 3 x 25 mm Screwdriver-Bits long type: PH 1 - PH 2 x 75 mm 7027 Bits PZ 0 - PZ 1 - PZ 2 - PZ 2 - PZ 3 x 25 mm 7028 Bits 3 - 4 - 5 - 6 x 25 mm 7033 Bits T6 - T7 - T8 - T9 - T10 - T15 - T20 - T25 - T27 - T30 - T40 x 25 mm Screwdriver-Bits long type: T25 - T30 x 75 mm 8191 Lanyard with snap hook for scuring the reversible ratchet				

The smartyBOX S2 and S3.

The perfect supplement.



■ smartyBOX S2



- including the new MATADOR Z90 3/8" reversible ratchet
- Covers 90 % of all screw tasks with socket sizes from 6 - 22 mm
- 8° swivelling extension bars included for screw connections that are difficult to reach
- With adjustable wrench, perfect for countering or screw tasks that require an open ended spanner (e.g. when bolts are in the way)
- Sockets with double smart drive profile
- Everything is fit securely into MFS soft foam inlays and survives even the hardest fall



Art. Code	b mm	h mm	t mm	g	
8145 3115	260	63	156	1300	1

- Content
- 0590** Adjustable Wrench 1 - 20 mm (8")
 - 3061** Reversible Ratchet
 - 3065** Swivelling Extension Bars 75 - 125 mm
 - 3068** Universal Joint
 - 3075** 6 - 7 - 8 - 9 - 10 - 11 - 12 - 13 - 14 - 15 - 16 - 17 - 18 - 19 - 20 - 21 - 22 mm
 - 3084** Bit-Adapter F
 - 3085** Drill Adapter for Sockets
 - 8191** Lanyard with snap hook for securing the reversible ratchet

■ smartyBOX S3



- Innovative supplement with combination ratchet spanners and ratchet adapters
- Combination ratchet spanners with lever for quick change of direction
- With slightly angled ring side
- Includes the most important spanner sizes from 7 - 19 mm and 4 additional ratchet adapters for using the ratchet spanners as a fully usable ratchet for sockets
- Everything is fit securely into MFS soft foam inlays and survives even the hardest fall



Art. Code	b mm	h mm	t mm	g	
8145 0189	260	63	156	1300	1

- Content
- 0189** 7 - 8 - 10 - 12 - 13 - 15 - 17 - 19 mm
 - 0186** Bitadapter for Combination Ratchet Spanners SW 10
 - 0186** Ratchet Adapter for Combination Ratchet Spanners SW 10
 - 0186** Ratchet Adapter for Combination Ratchet Spanners SW 13
 - 0186** Ratchet Adapter for Combination Ratchet Spanners SW 19



The smartyBOX S4.

The next generation's socket sets.

S4

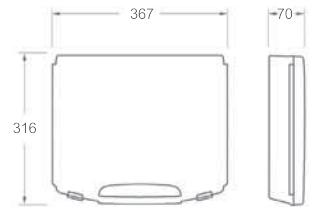

Size:
B 367 x T 316 x H 70 mm.



Sockets with double Smart Drive profile and super chrome coating.



Quality ratchet with 90 teeth and only 4° swivel angle for up to 750 N · m.

■ smartyBOX S4

1/2 29

- The MATADOR i-Boxx 72 protects the socket set from splash water and ensures maximum order
- It can be integrated into the MATADOR system
- The sturdy stacking box has a load capacity of up to 5 kg and gives a perfect overview thanks to the transparent closure lid and inscribable handle
- Everything is fit securely into MFS soft foam inlays and survives even the hardest fall



Art. Code	b mm	h mm	t mm	g	
8145 4114	367	70	316	4470	1

- Content
- 4061** Reversible Ratchet
 - 4064** Sliding Handle
 - 4065** Extension 125 mm
 - 4068** Universal Joint

- 4075** 8 - 9 - 10 - 11 - 12 - 13 - 14 - 15 - 16 - 17 - 18 - 19 - 20 - 21 - 22 - 23 - 24 - 26 - 27 - 28 - 30 - 32 mm
- 4081** 16 - 18 - 20,8 mm

The smartyBOX S5.

The next generation's socket sets.

S5

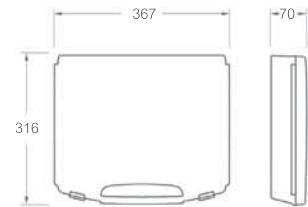

Size:
B 367 x T 316 x H 70 mm.



MATADOR reversible ratchet for the smallest gaps.



Standard bits made of high-alloy S2 material with color guide system.

Patented spinner handle with bayonet mount for bit and square drive.

■ smartyBOX S5

- The MATADOR i-Boxx 72 protects the socket set from splash water and ensures maximum order
- It can be integrated into the MATADOR system
- The sturdy stacking box has a load capacity of

up to 5 kg and gives a perfect overview thanks to the transparent closure lid and inscribable handle

- Everything is fit securely into MFS soft foam inlays and survives even the hardest fall

1/4 1/2 3/8

Art. Code	b mm	h mm	t mm	g
8145 4118	367	70	316	4740

Inhalt	Art. Code	Dimensions
	2061	Reversible Ratchet
	2064	Sliding Handle
	2065	Extension 50 - 100 mm
	2068	Universal Joint
	2073	Multi Component Spinner Handle
	2075	4 - 4.5 - 5 - 5.5 - 6 - 7 - 8 - 9 - 10 - 11 - 12 - 13 - 14 mm
	2085	Drill Adapter for Sockets
	7026	Bits 3 - 3.5 - 4.5 - 5.5 - 6.5 x 25 mm
	7027	Bits PH 0 - PH 1 - PH 2 - PH2 - PH 3 x 25 mm
	7027	Bits PZ 0 - PZ 1 - PZ 2 - PZ2 - PZ 3 x 25 mm
	7028	Bits 3 - 4 - 5 - 6 x 25 mm
	7033	Bits T6 - T7 - T8 - T9 - T10 - T15 - T20 - T25 - T27 - T30 - T40 x 25 mm
	4061	Reversible Ratchet
	4064	Sliding Handle
	4065	Extension 125 mm
	4068	Universal Joint
	4075	10 - 11 - 12 - 13 - 14 - 15 - 16 - 17 - 18 - 19 - 20 - 21 - 22 - 23 - 24 - 26 - 27 - 28 - 30 - 32 mm



The smartyBOX L1.

Multifunctional. Versatile. Flexible.

L1

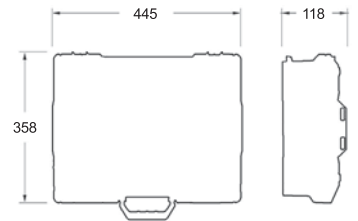

Size:
B 445 x T 358 x H 118 mm.



Including removable smartyBOX S1 with folding handle.



Stackable by simply clicking and separating the boxes.

■ smartyBOX L1

1/4 1/2 80



Art. Code	b mm	h mm	t mm	g	
8145 4150	445	118	358	5970	1

<ul style="list-style-type: none"> 0500 3C Combination Pliers 160 mm 0500 Retaining Clip for Combination Pliers 2061 Reversible Ratchet 2065 Extensions + 50 - 100 mm 2068 Universal Joint 2073 Multi Component Spinner Handle 2075 4 - 4,5 - 5 - 5,5 - 6 - 7 - 8 - 9 - 10 - 11 - 12 - 13 - 14 mm 2084 Bit-Adapter F 2084 Bit-Adapter M 7040 Drill Adapter for Bits 	<ul style="list-style-type: none"> 7026 Bits 3 - 3,5 - 4,5 - 5,5 - 6,5 x 25 mm Screwdriver-Bits long type: 4 - 6 x 75 mm 7027 Bits PH 0 - PH 1 - PH 2 - PH 2 - PH 3 x 25 mm Screwdriver-Bits long type: PH 1 - PH 2 x 75 mm 7027 Bits PZ 0 - PZ 1 - PZ 2 - PZ 2 - PZ 3 x 25 mm 7028 Bits 3 - 4 - 5 - 6 x 25 mm 7033 Bits T6 - T7 - T8 - T9 - T10 - T15 - T20 - T25 - T27 - T30 - T40 x 25 mm Screwdriver-Bits long type: T25 - T30 x 75 mm 4061 Reversible Ratchet 4065 Extension 125 mm 4068 Universal Joint 4075 8 - 9 - 10 - 12 - 13 - 14 - 15 - 16 - 17 - 18 - 19 - 20 - 21 - 22 - 24 - 26 - 27 - 30 - 32 mm 4081 16 - 18 - 20,8 mm 8191 Lanyard with snap hook for scouring the reversible ratchet
---	--

The smartyBOX L2.

The allround set for professionals.

L2

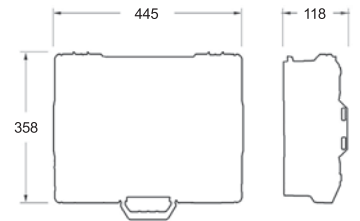

Size:
B 445 x T 358 x H 118 mm.



Tool compartment in the lid with even more premium tools.

■ smartyBOX L2



Art. Code	Icon	Dimensions	Weight	Volume		
		b mm	h mm	t mm	g	
8145 4145		445	118	358	6360	1
		0185	8 - 10 - 11 - 13 - 14 - 17 - 19 - 22 mm			
		0440	1,5 - 10 mm			
		0443	T10 - T50			
		0500	3C Combination Pliers 180 mm			
		0532	3C Sidecutter 160 mm			
		0556	Water pump pliers 240 mm			
		0705	500 g			
		0714	200 mm			
		0787	250 mm			
		0825	200 mm			
		0797	2 m			
		2K 0615	0.6 x 4.0 x 75 - 0.8 x 5.0 x 100 - 1.0 x 5.5 x 125 1.2 x 6.5 x 150 mm			
		2K 0655	PH1 x 80 - PH2 x 100 mm			
		0655	0.5 x 3.0 x 65 mm			
		0664	1.5 - 3.0 - PH00 - PH0			



MATADOR Tool Cases.

Ideal for work, home and hobby.

■ Tool Assortment Automotive

6.3 mm 1/4 12.5 mm 1/2



The 103-pc. tool assortment **Automotive** is the ideal compilation of sockets and screwdriver sockets for all kind of car repair and maintenance work in industrial areas. Thanks to the soft-foam inlay the tools are arranged in a shakeproof way and do not fall off during transport.

- Full socket set in 6,3(1/4) - 12,5(1/2) with the most important sockets from 4 - 32 mm
- Extensive assortment of screwdriver sockets (short and long type) including TORX[®]
- Spark Plug Sockets 14 - 20,8 mm, etc.
- Everything is fit securely into MFS soft foam inlays and survives even the hardest fall

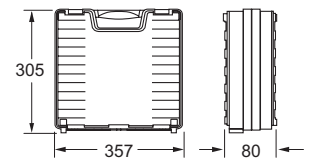

Art. Code

4150 9120 



b mm 357 h mm 80 t mm 305 g 7300 1



High quality case „Made in Germany“ in a compact design.



High functionality and easy-to-open intermediate plate.

Inhalt	Icon	Size	Art. Code	Description
		6.3 mm 1/4	2061	
		6.3 mm 1/4	2064	
		6.3 mm 1/4	2065	50, 100 mm
		6.3 mm 1/4	2068	
		6.3 mm 1/4	2073	150 mm
		6.3 mm 1/4	2075	4 - 4,5 - 5 - 5,5 - 6 - 7 - 8 - 9 - 10 - 11 - 12 - 13 - 14 mm
		6.3 mm 1/4	2076	4 - 5,5 - 7 x 32 mm
		6.3 mm 1/4	2077	PH 1 - PH 2 - PH 3 x 32 mm
		6.3 mm 1/4	2078	3 - 4 - 5 - 6 - 8 x 32 mm
		6.3 mm 1/4	2090	E4 - E5 - E6 - E7 - E8 - E10 - E11
		6.3 mm 1/4	2092	T8 - T10 - T15 - T20 - T25 - T27 - T30 - T40 x 32 mm
		10 mm 3/8	3081	14 - 16 - 18 - 20,8 mm
		12.5 mm 1/2	4061	
		12.5 mm 1/2	4065	125, 250 mm
		12.5 mm 1/2	4068	
		12.5 mm 1/2	4075	10 - 11 - 12 - 13 - 14 - 15 - 16 - 17 - 18 - 19 - 20 - 21 - 22 - 23 - 24 - 27 - 30 - 32 mm
		12.5 mm 1/2	4078	4 - 5 - 6 - 7 - 8 - 10 - 12 - 14 x 62 mm 6 - 7 - 8 x 100 mm
		12.5 mm 1/2	4082	12,5 (1/2) - 10 (3/8)
		12.5 mm 1/2	4090	E10 - E12 - E14 - E16 - E18 - E20 - E22 - E24
		12.5 mm 1/2	4092	T20 - T25 - T27 - T30 - T40 - T45 - T50 - T55 - T60 x 62 mm T30 - T40 - T45 x 100 mm

The most important 125 high quality hand tools for work, home and hobby in one case. Compact. Complete. Uncompromising.

Tool Case Black Box

6,3 mm 1/4 12,5 mm 1/2

The MATADOR „BlackBox“ is a real surprise box. It contains everything a demanding and ambitious (hobby) mechanic needs for **large and small repairs and maintenance**. Thought-out compilation of tools, uncompromising quality and **many multifunctional tools**.

Shake-proof tool storage thanks to soft foam inlay that keeps all tools in place during transport. In well-designed and stable plastic case.

- 4-pc pliers set with 3KsoftGrip handles inc. all-round side cutter for cutting, stripping, crimping and bending work
- 4in1 pocket screwdriver with pocket clip and the 4 most important screwdriver bits for slotted and cross-slotted (PH) screws incl. fine mechanics bits for glasses, mobile phone, keyboard, radio, etc.
- 4in1 ring ratchet spanner, suitable for 70% of all screwing work
- 6.3(1/4) smarty-BOX including the new reversible ratchet with 90 teeth for the smallest gaps
- 2 hex key sets for hexagon socket and TORX screws with softGRIP holder for quick key removal

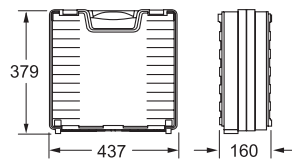

BlackBox.

Art. Code	b mm	h mm	t mm	g
4152 0001	437	160	379	9500

	0184	10 - 13 - 17 - 19 mm		2061	
	0185	8 - 10 - 11 - 13 - 14 - 17 - 19 - 22 mm		2065	
	0442	1.5 - 10 mm L		2075	6 - 7 - 8 - 9 - 10 - 11 13 mm
	0443	T10 - T50		2084	
	0500	165 mm (6.1/2")		2085	
	0553	190 mm (7.1/2")		7026	3 - 3.5 - 4.5 - 5.5 - 6.5 x 25 mm, 4 - 6 x 75 mm
	0585	205 mm (8")		7027	PH 0 - PH 1 - PH 2 - PH 2 - PH 3 x 25 mm PH 1 - PH 2 x 75 mm
	0556	240 mm (9.1/2")		7027	PZ 0 - PZ 1 - PZ 2 - PZ 2 - PZ 3 x 25 mm
	0660	0.5 x 3.0 x 100 mm		7028	3 - 4 - 5 - 6 x 25 mm
	0615	0.8 x 5.0 x 100 mm, 1.0 x 5.5 x 125 mm, 1.2 x 6.5 x 150 mm		7033	T6 - T7 - T8 - T9 - T10 - T15 T20 - T25 - T27 - T30 T40 x 25 mm, T25 - T30 x 75 mm
	0655	PH 0 x 60 mm, PH 1 x 80 mm PH 2 x 100 mm		7047	
	0635	0.5 x 3.0 x 65 mm		4061	
	0664	1.5 - 3.0 - PH 00 - PH 0		4064	300 mm
	0705	300 g		4065	125 - 250 mm
	0714	150 mm		4068	
	0717	4 x 120 x 10 mm		4075	10 - 11 - 12 - 13 - 14 - 15 - 16 - 17 - 18 - 19 - 22 - 24 27 - 30 - 32 mm
	0718	∅ 3 - 4 - 5 - 6 mm		4085	
	0775	150 mm		4081	16 - 18 - 20.8 mm
	0784	270 g Neodym		7110	XL (9)
	0787	250 mm			
	0798	5 m			
	0828	170 mm			



High quality case „Made in Germany“ in a compact design.



Solid polypropylene construction with wide and rubberized handle.

■ Tool case COW

- Classic tool case for trainees and mechanics
- Carefully processed, made of strong cowhide
- Interior measurement: 420 x 250 x 160 mm



Removable shoulder strap



Side locks to avoid accidental opening



Ergonomic handle



Supplied with 2 keys

Bag body reinforced with aluminium.

Tool Assortment MECHANICS M not included.

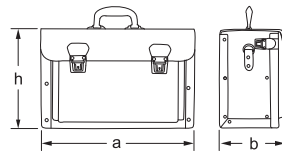

Art. Code		a mm	h mm	b mm	g	
8115 0001	Tool case COW empty	455	305	195	2800	1
8115 0002	Belt 1200 x 20 mm				100	1

■ Tool case SOFT

Additional strap for transport fixation.



Double-fixed strap.

90° fidding front wall.



Tools not supplied.

Spray-water repellent ground on four plastic feeds.

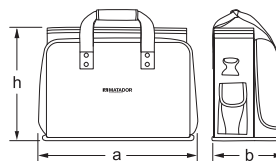

- Multifunctional technician tool case made of highly durable nylon



Flexible strap



Padded internal pockets for laptop and DIN A4 documents



Soft shoulder straps



Removable shoulder strap



With fixing belt for mounting on trolleys



Two zippers for security pad locks



Art. Code		h mm	a mm	b mm	g	
8125 0001	Tool case SOFT empty	350	430	230	2300	1

■ Tool cases ABS

- Oil and water resistant
- Shock proof and extra large capacities



Art. Code	Volume l	Max. load kg	h mm	a mm	b mm	g	
8130 0001	26	25	390	500	190	4880	1

Tools not supplied.

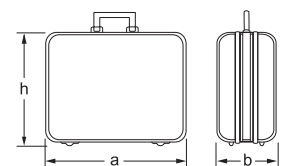

Variable inserts for further separation



3-digit combination lock



Two lockable clip locks



Circumferential robust aluminium frame with shock edge protection



Color-contrasting stitchings



Two in-line skate wheels

Also as trolley available (8130 0002):



8130 0002 can be used as trolley



Sturdy ergonomic handle



■ Tool case CADDY

- Double walled case made of HDPE plastic
- Body case can be individually compartmentalised

Shock edge profile as cover and design element.



Aluminum frame, hardened and rigid.

2 tool panels with elastic bands and pocket.

One panel one-sided, one panel double-sided.

Tools not supplied.

Art. Code	Volume l	Max. load kg	h mm	a mm	b mm	g	
8132 0001	40	30	370	485	190	8000	1

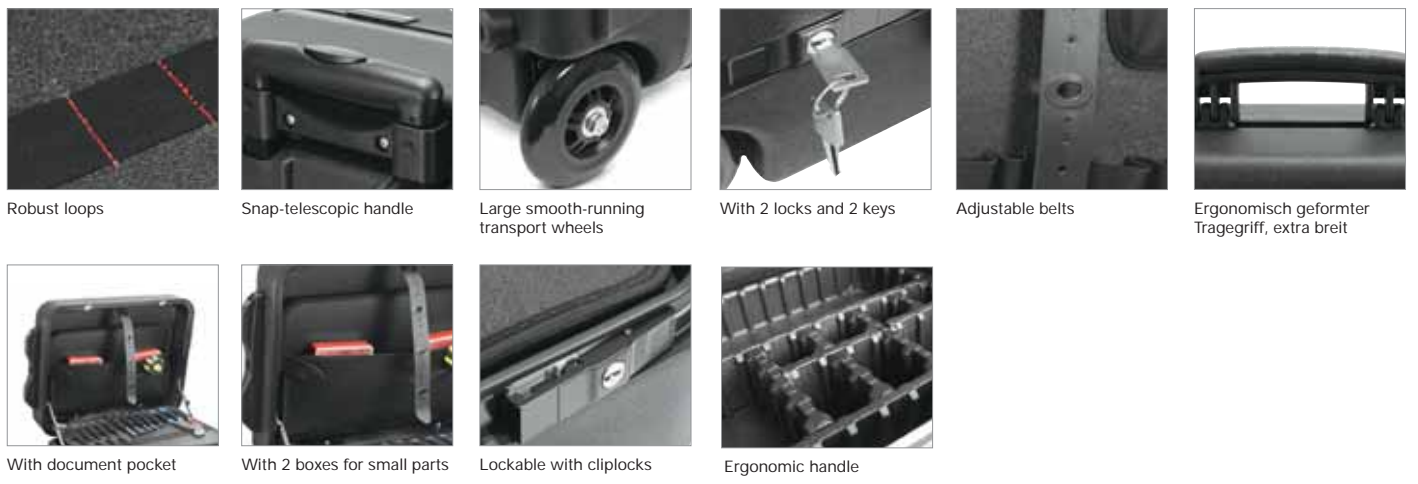
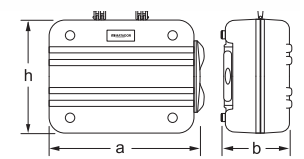

Robust loops

Snap-telescopic handle

Large smooth-running transport wheels

With 2 locks and 2 keys

Adjustable belts

Ergonomisch geformter Tragegriff, extra breit

With document pocket

With 2 boxes for small parts

Lockable with cliplocks

Ergonomic handle



■ Tool case CADDY with Tool Assortment UNIVERSAL XL

156



Art. Code	Weight (g)	Volume (l)
8132 8014	14800	1
Content		
0190 8 - 9 - 10 - 12 - 13 - 14 - 15 - 17 - 18 - 19 mm		
0442 1,5 - 2 - 2,5 - 3 - 4 - 5 - 6 - 8 - 10 mm		
0500 7" - 180 mm		
0530 8" - 200 mm		
0556 240 mm		
0615 5 x 100 - 6,5 x 150 mm		
0640 6,5 x 25 mm		
0641 PH 2		
0655 PH 1 - PH 2		
0705 400 g		
0714 125 mm		
0716 3 mm		
0775 200 mm 5 pcs		
0798 3 m		
0826 180 mm		
0843 210 mm		
2140 46 pcs:		
2061		
2064 115 mm		
2065 50, 100 mm		
2068		
2073 150 mm		
2075 4 - 4,5 - 5 - 5,5 - 6 - 7 - 8 - 9 - 10 - 11 - 12 - 13 - 14 mm		
2076 4 - 7 x 32 mm		
2077 PH 1 - PH 2 x 32 mm		
2077 PZ 1 - PZ 2 x 32 mm		
2078 3 - 4 - 5 - 6 - 8 x 32 mm		
2090 E4 - E5 - E6 - E7 - E8 - E10 - E11		
2092 T8 - T10 - T15 - T20 - T25 - T27 - T30 - T40 x 32 mm		
2084 6,3 (1/4) - 6,3 (1/4) Bit		
4135 40 pcs:		
4061		
4065 125, 250 mm		
4068		
4075 10 - 11 - 12 - 13 - 14 - 15 - 16 - 17 - 18 - 19 - 20 - 21 - 22 - 23 - 24 - 27 - 30 - 32 mm		
4084 12,5 (1/2) - 6,3 (1/4) Bit		
4090 E10 - E12 - E14 - E16 - E18 - E20 - E22 - E24		
4092 T20 - T25 - T27 - T30 - T40 - T45 - T50 - T55 - T60 x 62 mm		
7050 31 pcs.:		
7048 6,3 (1/4) - 6,3 (1/4) 60 mm		
7026 3x 0,8 x 4,5 - 1,0 x 5,5 - 1,2 x 6,5 mm		
7027 3x PH 1 - PH 2 - PH 3		
7027 3x PZ 1 - PZ 2 - PZ 3		
7028 3x 3 - 4 - 5 mm		
7032 3x T10 - T15 - T20 - T25 - T30 - T40		



Tool trolley ALLROUND.

The mobile workshop.



Stay mobile with the MATADOR premium trolley ALLROUND including 185-pc tool set.

Extremely robust, double-walled tool case with telescopic handle and smooth-running wheels. Comprehensive tool set „Best of MATADOR“.

Incl. smartyBox.
smartyBOX





Snap-lock telescopic handle.



Bottom can be divided by variable inserts.



3K softGRIP

Innovative pliers set with 3C handles and many additional functions.



Large, smooth-running wheels.



smartyBOX

Including smartyBOX, our practical universal socket box.

Art. Code	a mm	b mm	h mm	g	
8132 0185	485	190	370	13700	1

Content		Content	
	0190 8 - 32 mm		0786 440 mm
	softGRIP 0442 1,5 - 10 mm L		0798 5 m
	softGRIP 0444 T10 - T50		0743 140 mm
	3K 0500 165 mm (6.1/2")		0745 250 mm
	3K 0530 165 mm (6.1/2")		0826 180 mm
	3K 0585 170 mm (6.3/4")		0762 Drill assortment HSS-R
	0556 240 mm (9.1/2")		0775 200 mm 5-tlg.
	0588 250 mm (10")		0782 290 x 40 mm
	0591 300 mm (12")		0784 1.000 g
	2K 0616 4 x 100 mm		0798 300 x 30 x 1,0 mm
	2K 0615 5,0 x 100 mm, 6,5 x 150 mm, 8,0 x 175 mm, 10,0 x 250 mm		0799 140 mm
	2K 0655 PH 1 x 80 mm, PH 2 x 100 mm PH 3 x 150 mm		0840 250 mm
	2K 0657 PZ 1 x 80 mm, PZ 3 x 150 mm		0843 5-tlg.
	0635 0,5 x 3,0 x 65 mm		4061 90°
	0671 10 - 13 x 230 mm		4064 300 mm
	0700 35 mm		4065 125 - 250 mm
	0705 300 g, 500 g		4068 12,6 mm 1/2
	0718 2 - 3 - 4 - 5 - 6 - 8 mm		4075 10 - 11 - 12 - 13 - 14 - 15 16 - 17 - 18 - 19 - 22 - 24 27 - 30 - 32 mm
	0719 3 - 4 - 125 - 150 mm		2155 smartyBOX, 47 pcs

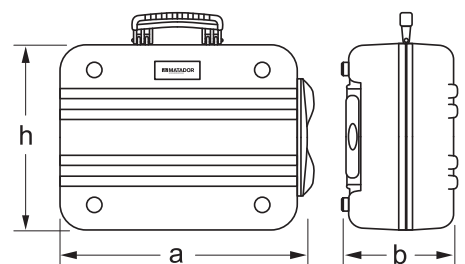

Outside dimensions::
370 (h) x 485 (a) x 190 (b)

■ Tool case STEEL 3

- In sheet steel, black-silver painted
- Ideal assistant for garden, home, garage and industry
- Well-tried and tested
- With 3 cases



Reversible handle.

2 side cases.

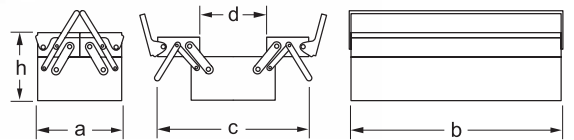

Art. Code	h mm	a mm	c mm	d mm	b mm	g	
8170 0020	150	200	330	135	420	3000	1



Solid construction in black-silver design



Lockable with padlock



Rounded handle edges

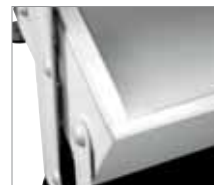

Tried and tested quality



With 3 or 5 compartments for different tools

■ Tool case STEEL 3 with tool assortment VDE



Art. Code	Tool case STEEL 3 with Tool Assortment VDE, 26 pcs.		g	
8170 0701			4500	1
Content	<ul style="list-style-type: none"> 0131 10 - 11 - 12 - 13 - 14 - 17 - 19 mm 0591 250 mm / 10" 0500 180 mm / 7" VDE 0532 160 mm / 6.1/4" VDE 0572 190 mm / 7.1/2" VDE 0576 160 mm / 6.1/4" VDE 0585 170 mm / 6.3/4" VDE 0616 0,5 x 3 x 100 - 0,8 x 4 x 100 - 1,0 x 5,5 x 125 1,2 x 6,5 x 150 mm VDE 	<ul style="list-style-type: none"> 0635 0,6 x 3,5 x 100 mm 0656 PH 1 - PH 2 VDE 0826 180 mm VDE 0744 140 mm VDE 0798 5 m 0879 Tin 1 mm x 2,8 m 0879 190 mm 0881 Multimeter 		

■ Tool case STEEL 5

- In sheet steel, black-silver painted
- Ideal assistant for garden, home, garage and industry
- Well-trie and tested
- With 5 cases



Reversible handle.

4 side cases.

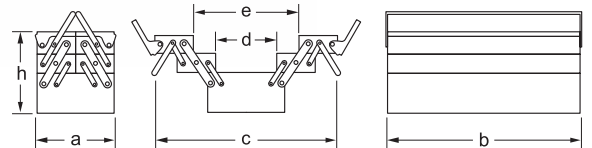

Art. Code	h mm	a mm	c mm	d mm	e mm	b mm	g	
8175 0020	200	200	460	135	265	520	5000	1

■ Tool case STEEL 5 with tool assortment UNIVERSAL

108

Art. Code	kg
8175 8013	25500

8175 8013 Tool case STEEL 5 with Tool Assortment UNIVERSAL, 108 pcs.

Content			
0100	6x7 – 30x32 mm	0780	
0200	6x7 – 30x32 mm	0781	
0440	1,5 - 10 mm	0782	
0500	7" - 180 mm	0783	
0530	7" - 180 mm	0852	
0556	240 mm	0786	
0425	240 mm	0814	
0596	0 - 60 mm - 1.1/2"	0825	
0615	5 - 6,5 - 8 - 10 mm	0840	
0633		0842	
0655	PH 1 - PH 2 - PH 3	0846	
0660	3 x 100 mm	0860	
0700	35 mm	4061	
0705	400 g	4064	
0718	3 - 4 - 5 mm	4065	125 - 250 mm
0719/2		4068	
0752	500 mm	4075	10 - 11 - 12 - 13 - 14 - 15 - 16 - 17 - 18 - 19 - 20 - 21 - 22 mm
0760	13 x 0,05 - 1,00 mm	4081	16 - 20,8 mm
0775	5 pcs		



Be yourself.



Be a MATADOR.

Terms and Conditions

General Terms and Conditions of MATADOR GmbH & Co. KG

§ 1 Scope

1. Our General Terms and Conditions are exclusively valid. We do not accept any regulations to the contrary or regulations that differ from our terms and conditions, unless we expressly agreed to them in written form. Our General Terms and Conditions are even valid if we execute orders without reservation despite being aware of alternative conditions on the part of the customer. All present and future business connections to the customer are subject to our General Terms and Conditions.
2. All agreements between the customer and us with regard to the execution of this contract are put into writing in this contract.
3. Our General Terms and Conditions are only valid for contracts with entrepreneurs in terms of § 310 German Civil Code.

§ 2 Quotations and Conclusion of the Contract

1. All quotations are without engagement regarding prices and possibilities for delivery.
2. All orders are only to be regarded as accepted after we have given our confirmation in written form. The same applies to additions and changes of orders.
3. The details, drawings, illustrations and performance descriptions contained in brochures, catalogues, price lists or other documentations that are part of a quotation are without engagement unless we expressly refer to them as being binding in our order confirmation.
4. All the documents mentioned are subject to our copyright. 5. The conclusion of the contract is effective subject to our timely and correct provision by our suppliers. The customer will immediately be informed about the default and payments already made will be refunded.

§ 3 Custom-made products

1. If we deliver articles that are made to customer's specifications the customer is responsible for ensuring that industrial property rights of third parties are protected. The customer is responsible for the correctness of the contents, their technical practicability and completeness.
2. In case of custom-made products we reserve the right to increase or reduce the quantity delivered by up to 10%. In case of especially manufactured articles we cannot accept a withdrawal from the contract or a return of the custom-made articles by the customer.

§ 4 Prices, Minimum Order Value / Handling Fee

1. Our prices are quoted in € and ex works unless stated differently in our order confirmation. They do not include packaging, freight, insurance, customs and other charges. They are invoiced separately.
2. Our prices are quoted exclusive of VAT. VAT is shown separately in the invoice.
3. The prices quoted are based on the production costs that apply at the date of the quotation. In the case of an increase in production costs due to a general increase in wage, material or other production costs we have to reserve the right to charge the prices that apply at the date of the delivery unless fixed prices are expressly agreed upon.
4. The minimum order value is € 50 net. For orders with a value of less than € 50 we charge a handling fee of € 7.50 plus VAT and postal charges.

§ 5 Payment

1. For payments within 10 days following the date of the invoice we grant a cash discount of 2% on the value of the goods. Payments within 30 days can only be accepted net.
2. Note charges and discount charges will be paid by the customer and are to be settled immediately.
3. In case of delayed payment we have to reserve the right to charge interests for delay on the basis of the interest rate valid at that time.

4. In case of delayed payment, incoming note protests or a considerable aggravation of the financial circumstances on the part of the customer we are entitled to demand other securities for current contracts or to cancel the contract. Moreover we reserve the right to render further services only on the basis of advance payment and to demand immediate payment of acceptances, bills of exchange or checks.

§ 6 Delivery Period

1. Delivery dates are to be regarded as approximately agreed upon unless a fixed date is stipulated.
2. In case of subsequent modifications of the contract by the customer that influence the delivery period, this period may change to an appropriate extent.
3. Delays in delivery or service that can not be attributed to us entitle us to postpone delivery by the duration of the obstruction. This is especially valid in case of force majeure, strike, lock-out, official directive etc.

§ 7 Delivery

1. Domestic deliveries are made ex works when the order value is below € 150. Deliveries by mail are also made ex works.
2. Export shipments are normally made free border or FOB German port respectively, packing included.
3. All deliveries are always made for the account and at the risk of the customer. MATADOR will not be responsible for any losses or damage that occur during transport.
4. Packing will be charged at cost price and is non-returnable. The customer bears the disposal costs.

§ 8 Notice of Defect

The notice of defect has to be sent to us immediately in written form and not later than 5 days after receipt of the goods.

§ 9 Warranty

1. For damage due to improper use, incorrect assembly / operation or modification of the goods delivered, wear and tear or incorrect handling we cannot assume liability.
2. If the goods delivered are defective or lack guaranteed characteristics we commit ourselves - at our own choice and excluding further warranties for defect - to repair or to replace the imperfect goods.
3. The customer has to inform us about defects immediately and in written form. In case of noticeable defects we have to be notified within five days after receipt of the goods, in case of hidden defects we have to be informed immediately after they have been discovered.
4. The manufacturer's product description solely specifies the good's characteristics. Additional comments made in public are not part of the contractual product description.
5. Warranty claims and claims for compensation due to consequential harm caused by a defect become time-barred after one year following delivery of the goods.

§ 10 Guarantee

All tools are subject to a full guarantee. We will replace every tool free of charge that has become unusable due to faulty workmanship or material. If testing in our plant, however, shows that the tools have been handled in an improper way, that their measurements have been changed or that their defects are due to wear and tear they cannot not be replaced free of charge. Rejected items are to be returned.

§ 11 Overall Commitment

1. In case of negligent violation of essential contractual obligations our liability is limited to the - according to the kind of good - predictable and typical average damage. In case of negligent violation of insignificant contractual obligations our liability is excluded. Warranty claims are not affected by this regulation. Moreover the limitation of our liability is not valid for damage caused to the customer's health that can be attributed to us.
2. Claims for damage due to defects become time-barred after one year following delivery of the goods. Again this does not apply in case of gross negligence on our part or in case of damage caused to the customer's health that can be attributed to us.

§ 12 Return of Goods

1. Basically, returns of goods are only possible after prior accord or after we have given our approval. We cannot accept returns that are made without our prior approval. 2. In any case goods have to be returned carriage paid. 3. We will charge a handling fee of 20% of the value of the goods.

§ 13 Reservation of Property Rights

1. Until the total claim resulting from the business connection will have completely been paid the goods remain our property. Acceptances, bills of exchange and checks are only to be regarded as payment after being honoured.
2. In case of a delay in payment or financial collapse we are entitled to demand the immediate handing over of the goods subject to our property rights. All fixed-term claims towards the customer become immediately due. Irrespective of their maturity date bills of exchange are to be honoured immediately.
3. The customer commits himself / herself to treat the goods subject to our property rights carefully and to insure them adequately.
4. Distraints of the goods subject to our property rights have to be reported to us immediately and the bailiff's return has to be enclosed.
5. The customer has the goods subject to our property rights at his / her disposal within the scope of ordinary business. After having suspended payment it is not permitted to mortgage, resell or assign the goods subject to our property rights as securities. If the customer sells the goods subject to our property rights on credit the title to claims that arises is to be regarded as immediately transferred to us. The customer is authorized to receive the payments out of this resale as long as this is not prohibited by us due to delays in payment or a financial collapse on the part of the customer. In this case the debtor has to deliver a declaration of transfer in duplicate about each claim on request.
6. If the article bought from MATADOR is compounded with other articles that are not part of our property we acquire joint ownership of the product in proportion to the other articles used.

§ 14 Place of Performance, Jurisdiction, Applicable Law, Partial Invalidity

1. Place of delivery and payment is Remscheid. The general place of jurisdiction for disputes of all kinds related to the contract is the Local Court in Remscheid or the Regional Court in Wuppertal. Priority is to be given to the regulations of § 38 ZPO. The contractual relationship is subject to German law excluding the regulations of the United Nations Convention on Contracts for the International Sale of Goods.
2. Should any regulation of these General Terms and Conditions be or become partly or fully ineffective or void this does not affect the validity of the other regulations. The ineffective regulation will be replaced

Technical Symbols.

General article data:		Internal rectangle drive 14 x 18 mm	Tolerance 1% to DIN EN ISO 6789	
Article-Code (code number)		Internal hex drive	Tolerance 2% to DIN EN ISO 6789	
Length		Internal hex drive	Tolerance 3% to DIN EN ISO 6789	
Height		Internal bi-hexagon	Tolerance 4% to DIN EN ISO 6789	
depth		External hex drive	Tolerance 5% to DIN EN ISO 6789	
Outside diameter		External drive 6.3 mm (1/4")	Tolerance 6% to DIN EN ISO 6789	
Weight		External drive 8 mm (5/16")	Certificate to DIN EN ISO 6789	
Pack unit		External drive 11 mm (7/16")	Weight torque multipliers	
Additional information		Internal drive 6.3 mm (1/4")	Power transmission (Ratio)	
Screw profile:		Internal drive 8 mm (5/16")		
Slot		Internal drive 11 mm (7/16")		
Phillips / Cross recess (PH)		Spanners:		
Pozidriv (PZ)		MM Key width in millimeters		
Hex		AF Wrench size in Zoll (AF")		
Internal serrations (XZN)		Wrench size mouth		
Multi-spline RIBE®		Wrench size ring		
Internal-TORX®		SmartDrive-Profil		
Internal-TORX® with pin (Tamper Resistant)		Set 4-pieces		
External-TORX®		Screw size		
5-Star / IP-Profile		Nut size		
Drives for sockets and bits:		Scale		
External square drive		Sockets:		
External square drive 6.3 mm (1/4")		Number of teeth Knarrengetriebe		
External square drive 10 mm (3/8")		36 Teeth		
External square drive 12.5 mm (1/2")		48 Teeth		
External square drive 20 mm (3/4")		60 Teeth		
External square drive 25 mm (1")		72 Teeth		
External square drive 40 mm (1.1/2")		Square drive		
External square drive 63 mm (2.1/2")		Torque-technology:		
Internal square drive		Indicating torque wrench		
Internal square drive 6.3 mm (1/4")		Triggering torque wrench		
Internal square drive 10 mm (3/8")		PC With PC interface		
Internal square drive 12.5 mm (1/2")		With rotation angle measurement		
Internal square drive 20 mm (3/4")		Gradation of the scale		
Internal square drive 25 mm (1")		With calibration certifikat according to DIN EN ISO 6789		
Internal square drive 40 mm (1.1/2")		Torque range from... till...		
Internal square drive 63 mm (2.1/2")		Input torque from...		
External rectangle drive		Output torque from...		
Internal rectangle drive		Operating instructions		
Internal rectangle drive 9 x 12 mm		Tolerance to DIN EN ISO 6789		
			Recommended internal tube diameter	
			Operating pressure	
			Air consumption	
			Filter	
			Oiler	
			Internal thread	
			External thread	
			Length locking pin	
			Pin	
			Rubber ring	
			Maximum loosening torque	
			Maximum torque	
			Recommended torque	
			Sound pressure level	
			Idle speed	
			Diameter blind rivet	
			Pulling force	
			Screwdriver:	
			Blade / Cutting edge width	
			Blade thickness	
			Blade length	
			Handle length	
			Total length	
			Blade length	
			Handle length	
			2K 2 components handle	
			VDE Test Symbol (Tools)	
			GS Seal of tested quality	
			△1000 V For working in voltage areas up to 1000 V	

Pliers:	
	Pliers cutting edge piano wire
	Pliers cutting edge hard wire
	Pliers cutting edge medium-hard wire
	Pliers cutting edge softwire
	Pliers cutting edge tube
	Pliers cutting edge round steel
	Pliers cutting edge cable
	Maximum cable cross-section
	Minimum cable cross-section
	Pliers cutting edge wire rope
	Jaw form
	Flat round jaws
	Flat jaws
	Concave jaws
	V-shaped jaws
	Round jaws
	Jaw form angle
	Pliers cutting edge material thickness
	Pliers cutting edge engineering steel
	Pliers cutting edge stainless steel
	Jaw form range
	Jaw form range
	Jaw form range
	Jaw form range
	Jaw form mouth wide
	Jaw form mouth length
	Jaw form serrated file-cut
	Jaw form flat file-cut
	Internal retaining ring
	Biggest Ø
	Smallest Ø
	External retaining ring
	Biggest Ø
	Smallest Ø
	Cutting form
	Cutting form with semi bevel
	Cutting form with bevel
	Cutting form center cutting
	Cutting form wire fitting spring

	Ø Tip
Miscellaneous tools:	
	Hammer head
	Wire thickness FE
	Wire thickness VA
	Thickness
	Cartridge
	Lifting capacity
	Square flatter
	Chisel 8-kant
	Width flat chisel
	Chisel width
	File profile flat
	File profile three-edged
	File profile round
	File profile square
	File profile half-round
	External puller width
	Internal puller width
	Puller height
Trolleys and accessories:	
	Suitable for Quadro
	Suitable for Ratio
	Suitable for Vario
	1/3 Modul
	3/3 Modul
	Available / o.k.
	Not available / not o.k.
	Drawers minimum height 50 mm
	Drawers minimum height 75 mm
	Drawers additional load 35 kg
	Drawers additional load 70 kg
	Drawers additional load 100 kg
	Total additional load 240 kg
	Total additional load 300 kg
	Total additional load 500 kg
	Total additional load 750 kg
	Total additional load 1000 kg
	Total additional load 1200 kg
	Total additional load 1250 kg

	Magnetic
	Left cutting
	Right cutting
Lamps:	
	High End LED
	High End Cree LED
	Lumen
	Fix focused lens
	Operating times in hours
	Waterproof according to IP 54
	Waterproof according to IP 67
	Supply 2 batteries LR14 (Baby), 1.5 volts
	Supply 3 batteries LR14 (Baby), 1.5 volts
	Supply 3 batteries LR14 (Baby), 4.5 volts
	Lamp diameter
	Length



Be a MATADOR.

Stay tuned.



www.matador.de

MATADOR GmbH & Co. KG

Morsbachtalstr. 17
42855 Remscheid
Germany

Tel. +49 2191 97 43 - 0
Fax +49 2191 97 43 - 44

sales@matador.de

Your dealer:

Delivery without decoration. Technical specifications subject to modifications.
No liability for printing errors. Please ask your local dealer.