

RED

ULTRA HD
SUPER RESISTANT
RED MATERIAL

QBRICK[®]
SYSTEM

ONE 2.0



様々な現場で対応できる車輪



取り外し可能な伸縮式ハンドル

頑丈なボディ



防水・防塵機能 (IP66)

ORGANIZERS

M 2.0



M Plus 2.0



L 2.0



XL 2.0

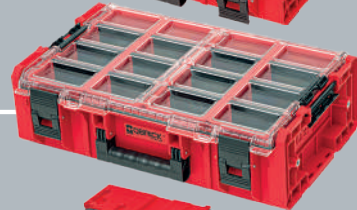

2XL 2.0

TOOLBOXES

Vario



Profi



Expert



200 2.0

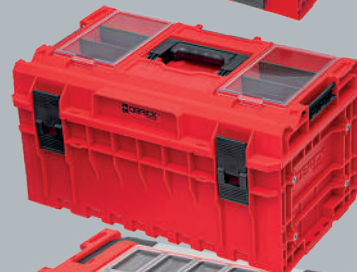

350 2.0



450 2.0

Box Plus 2.0



Transport Platform

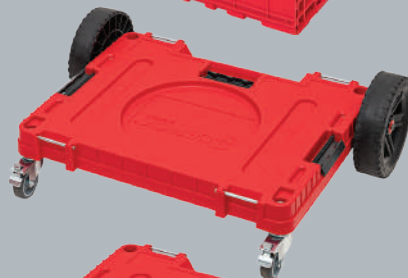

Transport Platform

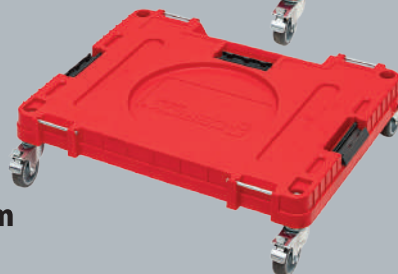

Cart



ONE

2.0

RED ULTRA HD

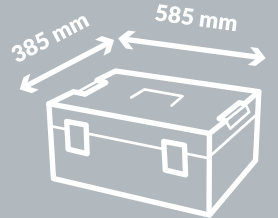

**Drawer 2
Toolbox 2.0**



**Drawer 3
Toolbox 2.0**

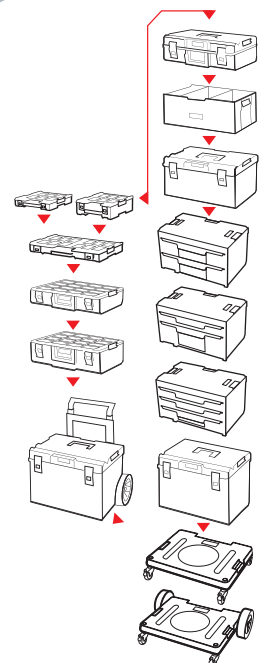



PATROL 社は 1991 年に創立され、経験豊富で創造的なエンジニアが、最新の技術と設備で革新的な収納用品をポーランドで製造しています。QBRICK SYSTEM は、耐久性があり大容量で機能的な収納用品であり、様々な組み合わせが可能です。

TOOL BOXES

Vario Series

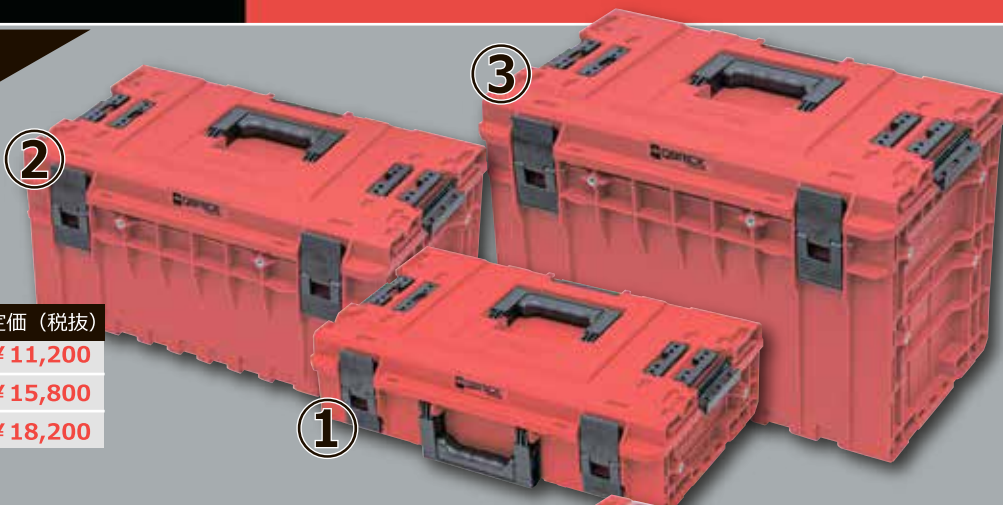

品番	サイズ	W×D×H(mm)	定価 (税抜)
①SKRQ200V2CCZEPG003	S	585×385×171	¥11,200
②SKRQ350V2CCZEPG003	M	585×385×301	¥15,800
③SKRQ450V2CCZEPG003	L	585×385×401	¥18,200

Profi Series

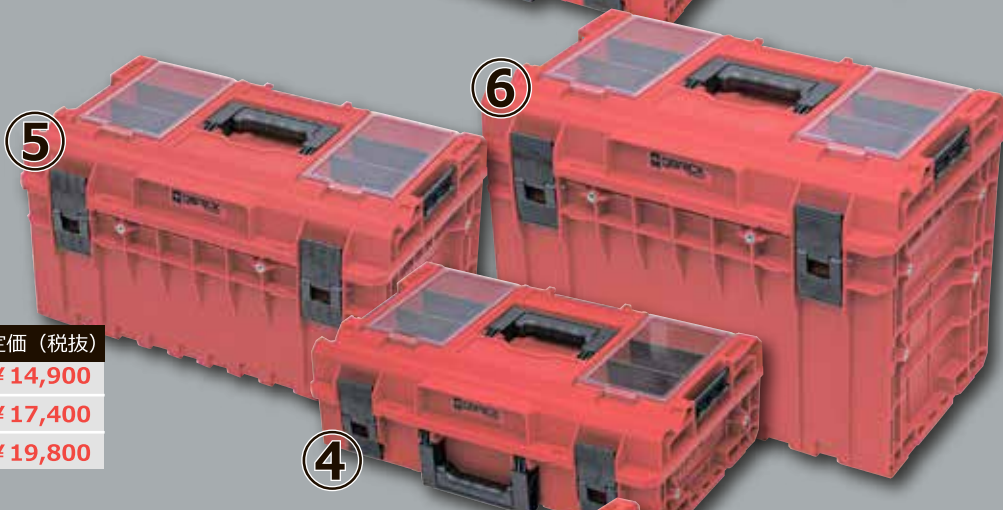

品番	サイズ	W×D×H(mm)	定価 (税抜)
④SKRQ200P2CCZEPG003	S	585×385×190	¥14,900
⑤SKRQ350P2CCZEPG003	M	585×385×322	¥17,400
⑥SKRQ450P2CCZEPG003	L	585×385×422	¥19,800

Expert Series

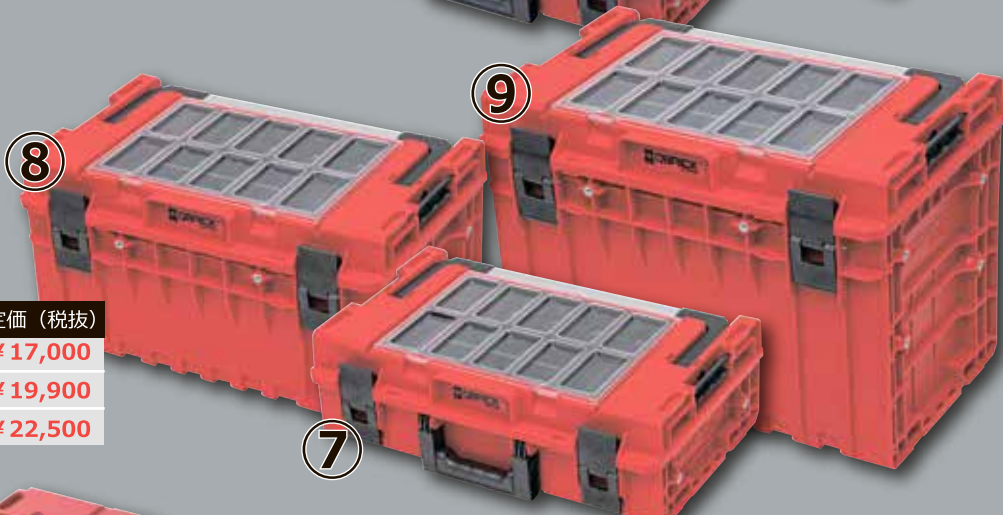

品番	サイズ	W×D×H(mm)	定価 (税抜)
⑦SKRQ200E2CCZEPG003	S	585×385×190	¥17,000
⑧SKRQ350E2CCZEPG003	M	585×385×301	¥19,900
⑨SKRQ450E2CCZEPG003	L	585×385×401	¥22,500

Drawer Series

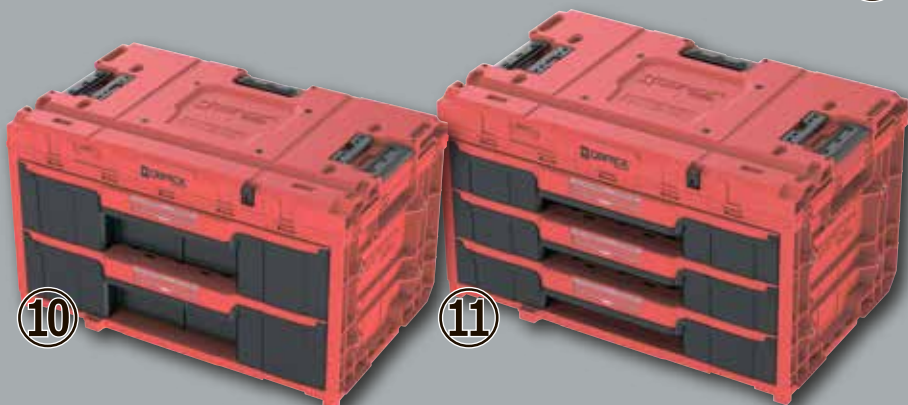

品番	段数	W×D×H(mm)	定価 (税抜)
⑩SKRQONED2CZEPG003	2	587×380×340	¥26,900
⑪SKRQONED3CZEPG003	3	587×380×340	¥31,300

ツールカート

Box Plus 2.0

・W×D×H(mm) : 576×359×237

品番 : ⑬SKRQPBOX2CCZEPG003

定価 : ¥7,900 (税抜)

⑬



ストッパー付キャスター

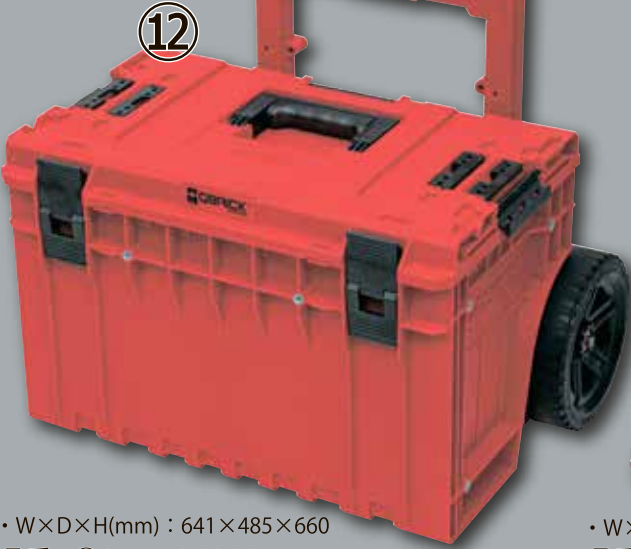

・W×D×H(mm) : 641×485×660

品番 : ⑫SKRWQCOCCZEPG003

定価 : ¥29,800 (税抜)



・W×D×H(mm) : 750×542×223

品番 : ⑭SKRQTPONE2ACZEPG003

定価 : ¥13,300 (税抜)

・W×D×H(mm) : 625×503×160

品番 : ⑮SKRQTPONE2WCZEPG003

定価 : ¥11,200 (税抜)

ORGANIZERS



M 2.0	品番	W×D×H(mm)	定価 (税抜)
フォーム有	⑯ORGQM2FCZEPG003	264×364×77	¥4,600
フォーム無	⑰ORGQM2CZEPG003		

M Plus 2.0	品番	W×D×H(mm)	定価 (税抜)
フォーム有	⑱ORGQMP2FCZEPG003	264×364×106	¥5,100
フォーム無	⑲ORGQMP2CZEPG003		¥5,000



L 2.0	品番	W×D×H(mm)	定価 (税抜)
フォーム有	⑳ORGQL2FCZEPG003	531×379×77	¥7,400
フォーム無	㉑ORGQL2CZEPG003		¥7,800

Long Bin



2XL 2.0	品番	W×D×H(mm)	定価 (税抜)
フォーム有	㉒ORGQ2XLFCZEPG003	531×379×77	¥17,100
フォーム無	㉓ORGQ2XLADCZEPG003		¥15,700

XL 2.0	品番	W×D×H(mm)	定価 (税抜)
フォーム無	㉔ORGQXL2CCZEPG003	582×387×131	¥13,000
フォーム無	㉕ORGQXL2LBCZEPG003		¥13,800



⑳