



 **suprabeam**®
Danish Design | Swiss Engineering

CONTENT - CONTENU - INHALT - INDHOLD - CONTENIDO

Q1		6
Q2		7
Q3		10
Q4		11
Q5		14
Q7		15
M6		18
V3_{air}		19
V3_{pro}		22
V4_{pro}		23
S2		26
S4		27
B6_r		32
ACCESSORIES - ACCESSOIRES - ZUBEHÖR - TILBEHØR - ACCESORIOS		38-39

UK HOW TO USE THE CATALOGUE - FR COMMENT UTILISER LE CATALOGUE - DE SO VERWENDEN SIE DEN KATALOG - DK HVORDAN MAN BRUGER KATALOGET - ES CÓMO USAR EL CATÁLOGO



UK LIGHT CURVES
FR COURBES DE PERFORMANCES
DE LICHTKURVEN
DK LYSKURVER
ES GRÁFICAS DE RENDIMIENTO



UK VIDEOS
FR VIDÉOS
DE VIDEOS
DK VIDEOER
ES VIDEOS



UK EXTENDED INFORMATION
FR COMPLÈMENTS D'INFORMATIONS
DE ERWEITERTE INFORMATIONEN
DK UDVIDET INFORMATION
ES INFORMACIÓN AMPLIADA

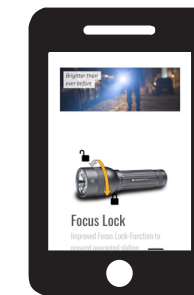

TEST



UK WHAT'S IN THE BOX
FR QU'Y A-T-IL DANS LA BOÎTE
DE INHALT
DK INDHOLD
ES EMBALAJE



UK FACTSHEETS
FR FICHES TECHNIQUES
DE DATENBLÄTTER
DK DATABLADE
ES FICHA TÉCNICA

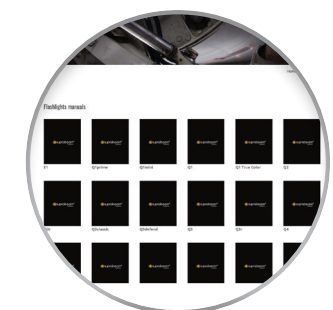

UK MANUALS
FR MANUELS
DE HANDBÜCHER
DK MANUALER
ES MANUALES



Q1_r



SUPRABEAM HIGHLIGHTS

- UK** Internal charging - Compatible with USB-C
- FR** Chargement interne - Compatible avec USB-C
- DE** Interne Ladung - Kompatibel mit USB-C
- DK** Intern opladning - Kompatibel med USB-C
- ES** Recarga interna - Compatible con USB-C



Q1 | POWERFUL PENLIGHTS

Q1 mini



SCAN FOR MORE INFO

Q2 | ULTRA COMPACT

Q2



SCAN FOR MORE INFO

UK INTERNAL USB-C CHARGING
FR CHARGEMENT INTERNE PAR USB C
DE INTERNE USB-C LADUNG
DK INTERN USB-C OPLADNING
ES RECARGA INTERNA USB-C



Q1r

UK POWERFUL PEN TORCH
FR LAMPE STYLO PUISSANTE
DE HELLE STIFTLAMPE
DK KRAFTIG PENLYGTE
ES LINTERNA POTENTE

UK ROTATING HYPERFOCUS
FR MISE AU POINT ROTATIVE
DE DREHBARER HYPERFOKUS
DK Roterende Hyperfokus
ES ENFOQUE GIRATORIO



P/N: 501.2011

120 LUMENS

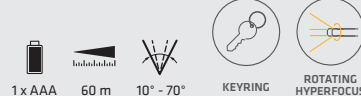

Q1



SCAN FOR MORE INFO



P/N: 501.3011

160 LUMENS

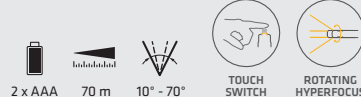

Q1 TRUE COLOR



SCAN FOR MORE INFO



P/N: 501.4011

160 LUMENS

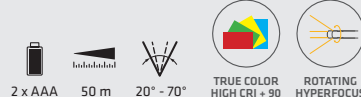

Q1r



SCAN FOR MORE INFO



P/N: 501.5011

550 LUMENS

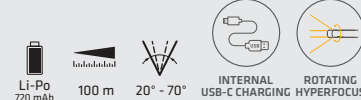

UK INTERNAL CHARGING
FR CHARGEMENT INTERNE
DE INTERNE LADUNG
DK INTERN OPLADNING
ES RECARGA INTERNA



Q2r

UK DIMMING + MEMORY
FR VARIATEUR + MEMOIRE
DE DIMMUNG UND MEMORY
DK DIMMING + HUKOMMELSE
ES ATENUADO + MEMORIA

UK HIGH CAPACITY LI-PO
FR LI-PO DE HAUTE CAPACITE
DE HOCHKAPAZITÄTS LI-PO
DK HØJKAPACITETS BATTERI
ES ALTA CAPACIDAD LI-PO



P/N: 502.1011

200 LUMENS

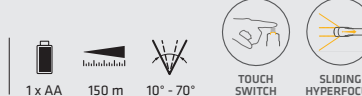

Q2r



SCAN FOR MORE INFO



P/N: 502.5011

450 LUMENS

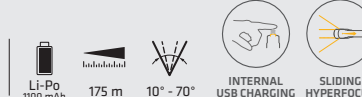

Q2r
INTERNAL CHARGING



Q1r

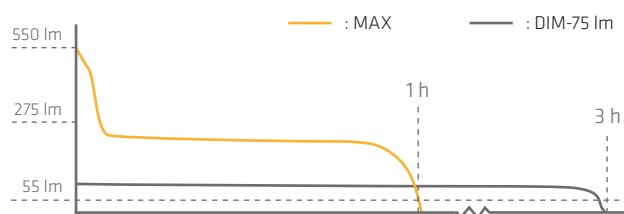

Q2r

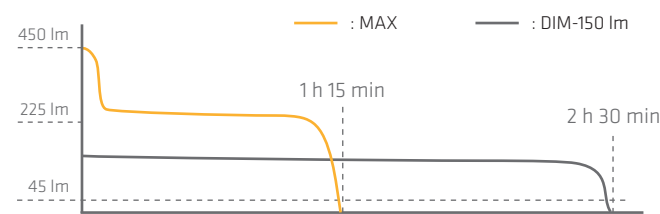



Q3r



SUPRABEAM HIGHLIGHTS

- UK** Waterproof - Tested to IP68, which ensures waterproof (2m) and dustproof protection.
- FR** Étanche à l'eau - Testé selon l'IP68, il garantit protection contre l'eau (immersion 2m) et la poussière.
- DE** Wasserdicht - Ein Produkt mit der IP68 Schutzart ist wasserdicht bis auf 2 Meter Tiefe.
- DK** Vandtæt - Testet til IP68 klassificering hvilket gør den støvtæt samt vandtæt ned til 2 meter.
- ES** Resistente al agua - Producto resistente al agua y al polvo clasificado como IP68

Q3 | COMPACT POWER

UK WATER- AND DUSTPROOF - IP68
 FR ÉTANCHE À L'EAU ET À LA POUSSIÈRE - IP68
 DE WASSER UND STAUBDICHT - IP68
 DK VAND- OG STØVTÆT - IP68
 ES RESISTENTE AL AGUA Y AL POLVO - IP68



Q3r

UK 3000 MAH BATTERY WITH USB
 FR BATTERIE 3000 MAH AVEC USB
 DE 3000 MAH BATTERIE MIT USB
 DK 3000 MAH BATTERI MED USB
 ES BATERÍA DE 3000 MAH CON USB

UK ROTATING HYPERFOCUS
 FR MISE AU POINT ROTATIVE
 DE DREHBARER HYPERFOKUS
 DK RØTERENDE HYPERFOKUS
 ES ENFOQUE DESLIZANTE

Q3 classic



SCAN FOR MORE INFO



P/N: 503.1511

330 LUMENS



Q3



SCAN FOR MORE INFO



P/N: 503.1111

380 LUMENS

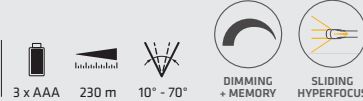

Q3r



SCAN FOR MORE INFO



P/N: 503.5211

1100 LUMENS

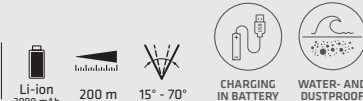

Q3r

WATERPROOF
 IP68

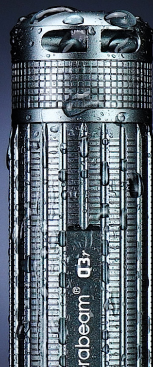

Q4 | FULL FEATURED

UK PROFESSIONAL POUCH INCLUDED
 FR ETUI PROFESSIONNEL INCLUS
 DE PROFI-GÜRTELTASCHE
 DK PROFESSIONEL TASKE
 ES FUNDA PROFESIONAL



Q4

UK DIMMING + MEMORY
 FR VARIATEUR + MEMOIRE
 DE DIMMUNG UND MEMORY
 DK DIMMING + HUKOMMELSE
 ES ATENUADO + MEMORIA

UK SLIDING HYPERFOCUS
 FR MISE AU POINT COULISSANTE
 DE SCHIEBE HYPERFOKUS
 DK GLIDENDE HYPERFOKUS
 ES ENFOQUE DESLIZANTE

Q4



SCAN FOR MORE INFO



P/N: 504.1011

400 LUMENS

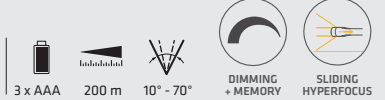

Q4 defend



SCAN FOR MORE INFO



P/N: 504.4011

400 LUMENS

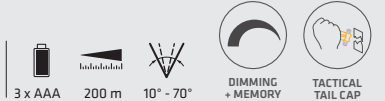

Q4 defend

ANTI ROLL RING



Q3r

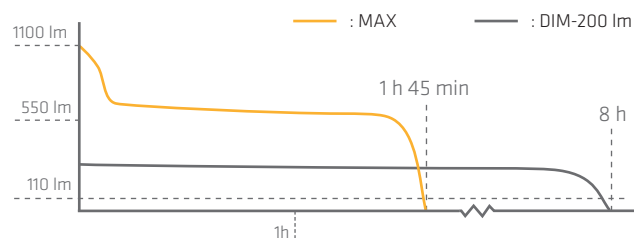

Q4

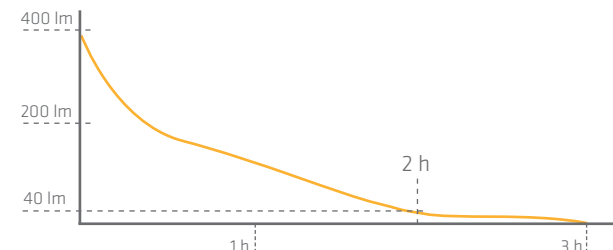



SUPRABEAM HIGHLIGHTS

- UK** External USB Charging - Two 5000 mAh high drain batteries are included as a standard
- FR** Charge externe via USB - Deux batteries de 5.000 mAh incluses
- DE** Externes Laden an USB - Zwei 5000-mAh-Batterien im Standardlieferumfang
- DK** Ekstern USB Ladestation - To 5000 mAh batterier inkluderet som standard
- ES** Rápida recarga externa - Se incluyen baterías de alto rendimiento de 5000 mAd como estándar



Q7 *xrs*

Q5 | TACTICAL RECHARGEABLE LIGHT

Q5^{xr} defend



Q7 | BRIGHTER THAN EVER BEFORE

Q7^{xrs}



- UK TACTICAL DESIGN
- FR DESIGN TACTIQUE
- DE TAKTISCHE DESIGN
- DK TAKTISK DESIGN
- ES DISEÑO TÁCTICO

Q5^{xr} defend



- UK INTERNAL SMART CHARGING
- FR CHARGE INTERNE INTELLIGENTE
- DE INTELLIGENTE INTERNE LADUNG
- DK SMART INTERN LADNING
- ES RECARGA INTERNA INTELIGENTE

- UK DIMMING + MEMORY
- FR VARIATEUR + MEMOIRE
- DE DIMMUNG UND MEMORY
- DK DIMMING + MEMORY
- ES ATENUADO + MEMORIA

P/N: 505.7005

1000 LUMENS

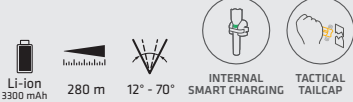

Q5^{xr} defend INTERNAL SMART CHARGING



- UK DC CONVERTER TECHNOLOGY
- FR TECHNOLOGIE DE CONVERSION CC
- DE GLEICHSTROMWANDLER TECHNOLOGIE
- DK DC CONVERTER TEKNOLOGI
- ES TECNOLOGÍA CON CONVERTIDOR DC



Q7^{xrs}

- UK DIMMING + MEMORY
- FR VARIATEUR + MEMOIRE
- DE DIMMUNG UND MEMORY
- DK DIMMING + HUKOMMELSE
- ES ATENUADO + MEMORIA

- UK EXTERNAL USB CHARGING
- FR CHARGE EXTERNE VIA USB
- DE EXTERNES LADEN AN USB
- DK EKSTERN USB LADESTATION
- ES RÁPIDA RECARGA EXTERNA

P/N: 507.6205

2000 LUMENS



Q7^{xrs} SLIDING HYPERFOCUS

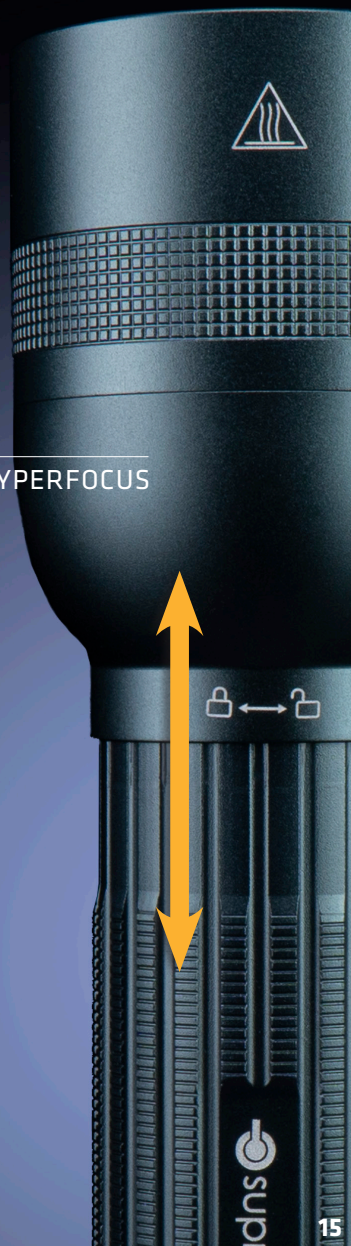

Q5^{xr} defend

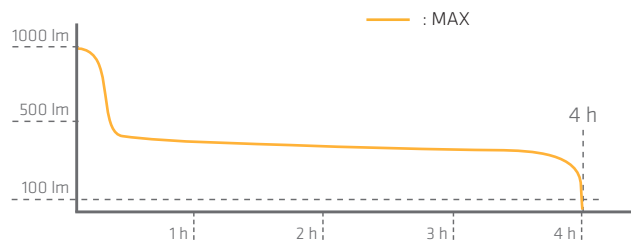

Q7^{xrs}

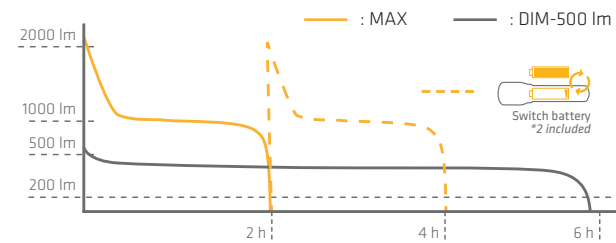



SUPRABEAM HIGHLIGHTS

- UK** M6xr has all the mounting options of our flashlight and headlamps combined
- FR** La M6xr accepte a la fois toutes les options de montage de nos torches et de nos frontales.
- DE** Die M6xr beinhaltet alle Befestigungsoptionen unserer Taschen- und Stirnlampen kombiniert.
- DK** Multilampen har alle monteringsmulighederne fra vores lommelygter og pandelamper.
- ES** M6xr tiene todas las opciones de montaje de nuestras linternas de mano y frontales.



M6xr

M6 | MULTILAMP

FOR MULTIPURPOSE

UK ELECTRONIC SWITCH + DIMMING
 FR INTERRUPTEUR ELECTRONIQUE ET VARIATEUR
 DE ELEKTRONISCHER SCHALTER + DIMMUNG
 DK ELEKTRONISK KONTAKT + LYSDÆMPNING
 ES SWITCH ELECTRÓNICO + ATENUADO

M6_{xr}

UK MULTI FUNCTIONAL
 FR MULTIFUNCTION
 DE MULTIFUNKTIONAL
 DK MULTIFUNKTIONEL
 ES MULTI FUNCIONAL

UK DC CONVERTER TECHNOLOGY
 FR TECHNOLOGIE DE CONVERSION DU
 COURANT CONTINU
 DE GLEICHSTROMWANDLER TECHNOLOGIE
 DK DC CONVERTER TEKNOLOGI
 ES TECNOLOGÍA CONVERTIDOR DC



V3_{air} | LIGHTWEIGHT

COMFORT

UK USB CHARGING
 FR RECHARGE USB
 DE USB LADUNG
 DK USB LADNING
 ES CARGA USB

UK ELECTRONIC DIMMING
 FR VARIATEUR ÉLECTRONIQUE
 DE ELEKTRONISCHER DIMMER
 DK ELEKTRONISK LYSDÆMPNING
 ES ATENUADO ELÉCTRICO

UK SLIDING HYPERFOCUS
 FR MISE AU POINT COULISSANTE
 DE SCHIEBE-HYPERFOKUS
 DK GLIDENDE HYPERFOCUS
 ES ENFOQUE DESLIZANTE

V3_{air} rechargeable



M6_r



SCAN FOR MORE INFO



P/N: 526.5011

M6_{xr}

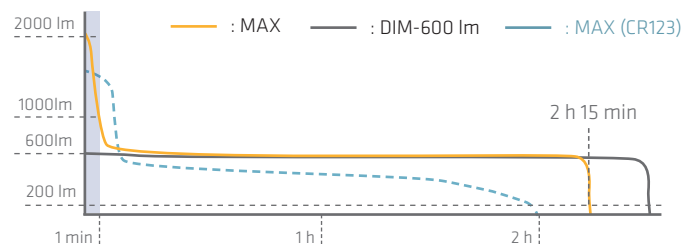

V3_{air}



SCAN FOR MORE INFO



P/N: 610.1011

V3_{air} rechargeable

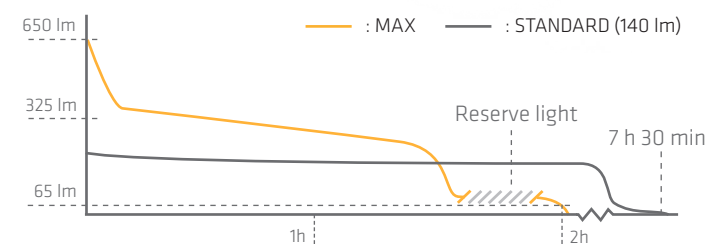

600 LUMENS | Li-Ion 3000 mAh | 150 m | 20° / 60° | MULTI-FUNCTIONAL | MAGNETIC

M6_{xr}



SCAN FOR MORE INFO



P/N: 526.6011

M6_{xr} MAGNETIC



2000 LUMENS | Li-Ion 3000 mAh | 165 m | 30° / 70° | MULTI-FUNCTIONAL | MAGNETIC

340 LUMENS | 3 x AAA | 195 m | 10° - 70° | SLIDING HYPERFOCUS | DIMMING + MEMORY

V3_{air} rechargeable



SCAN FOR MORE INFO



P/N: 610.5211

650 LUMENS | Li-Po 1400 mAh | 210 m | 10° - 70° | SLIDING HYPERFOCUS | CHARGING IN BATTERY

V3_{air} SLIDING HYPERFOCUS





V3 pro
rechargeable

SUPRABEAM HIGHLIGHTS

- UK** DC converter technology - Longer runtimes and more light
- FR** Technologie de conversion CC - Une autonomie plus importante et une lumière plus intense
- DE** Gleichstromwandler Technologie - Längere Leuchtdauer und mehr Licht
- DK** DC converter teknologi - Længere batterilevetid og højere lysudbytte
- ES** Tecnología de convertidor de DC - Tiempos de ejecución más largos y más luz.



V3 pro | PROFESSIONAL PERFORMANCE

V4 pro | VERSATILE FREEDOM

UK RED WARNING LIGHT
FR LUMIERE ROUGE DE SIGNALISATION
DE ROTES WARNLICHT
DK RØDT ADVARSELSSYLS
ES LUZ DE ADVERTENCIA

UK USB CHARGING
FR RECHARGE USB
DE USB LADUNG
DK USB LADNING
ES CARGA USB

UK SLIDING HYPERFOCUS
FR MISE AU POINT COULISSANTE
DE SCHIEBE-HYPERFOKUS
DK GLIDENDE HYPERFOCUS
ES ENFOQUE DESLIZANTE

UK USB CHARGING
FR RECHARGE USB
DE USB LADUNG
DK USB LADNING
ES CARGA USB

UK ELECTRONIC DIMMING
FR VARIATEUR ÉLECTRONIQUE
DE ELEKTRONISCHER DIMMER
DK ELEKTRONISK LYSDÆMPNING
ES ATENUADO ELÉCTRICO

UK SOFT FOAM PAD
FR COUSSINET EN MOUSSE SOUPLE
DE SCHAUMSTOFF PAD
DK BLØD SKUM PUDE
ES SOPORTE ESPUMADO



V3 pro rechargeable



V4 pro rechargeable

V3 pro rechargeable



SCAN FOR MORE INFO



P/N: 612.5211

V3 pro rechargeable

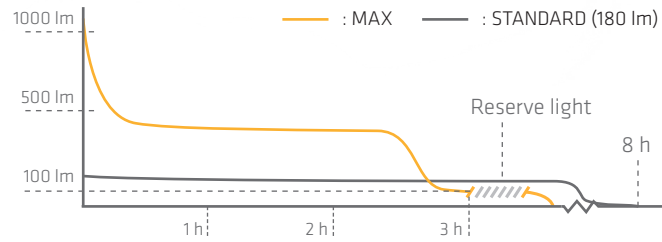

V4 pro rechargeable



SCAN FOR MORE INFO



P/N: 613.5211

V4 pro rechargeable

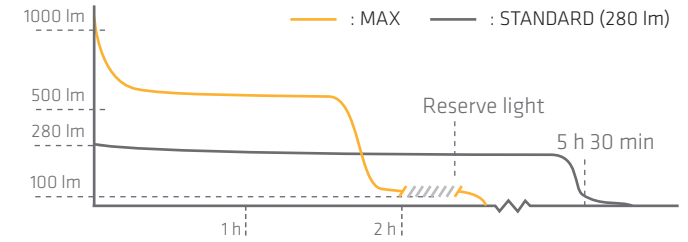

1000 LUMENS



V3 pro rechargerable

CHARGING IN BATTERY

V3 pro rechargeable

SLIDING HYPERFOCUS



1000 LUMENS



V4 pro rechargeable

RED WARNING LIGHT



V4 pro rechargeable

VERSATILE PLUG SYSTEM





SUPRABEAM HIGHLIGHTS

- UK** Dual optics - S4rechargeable has two different optical lenses
- FR** Double Optique - La S4rechargeable dispose de deux lentilles optiques différentes.
- DE** Doppeloptik - Die S4rechargeable hat zwei unterschiedliche Optiken.
- DK** Dobbelt optik - S4rechargeable er udstyret med to forskellige optiske linser.
- ES** Óptica Dual - La S4rechargeable cuenta con dos lentes diferentes.

S4rechargeable



S2 | DUAL LENS

DUAL ENERGY

UK DUAL ENERGY
FR DOUBLE ÉNERGIE
DE DOPPELTE ENERGIE
DK DUAL ENERGY
ES ENERGÍA DUAL

UK TRANSPORTATION LOCK
FR VERROUILLAGE DE TRANSPORT
DE TRANSPORTVERRIEGELUNG
DK TRANSPORTLÅS
ES BLOQUEO DE TRANSPORTE

UK DUAL OPTICS
FR DOUBLE OPTIQUE
DE DOPPELOPTIK
DK DOBBELT OPTIK
ES ÓPTICA DUAL



S4 | DESIGNED

FOR PROFESSIONALS

UK USB CHARGING
FR RECHARGE USB
DE USB LADUNG
DK USB LADNING
ES CARGA USB

UK HELMET MOUNT COMPATIBLE
FR MONTAGE CASQUE COMPATIBLE
DE MIT HELMHALTERUNG
DK HJELMMONTERING
ES COMPATIBLE CON MONTAJES PARA CASCOS

UK DUAL OPTICS
FR DOUBLE OPTIQUE
DE DOPPELOPTIK
DK DOBBELT OPTIK
ES ÓPTICA DUAL



S2



P/N: 602.1011

S2

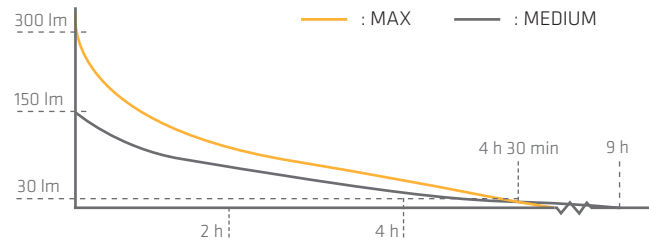

S4 rechargeable



P/N: 604.5011

S4 rechargeable

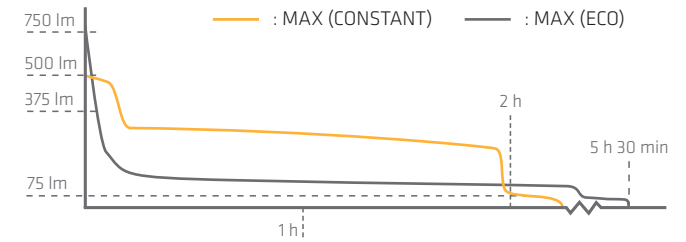

300
LUMENS



S2

WATER- AND DUSTPROOF



750
LUMENS



S4 rechargeable
HELMET MOUNT



S4 rechargeable

DC CONVERTER TECHNOLOGY

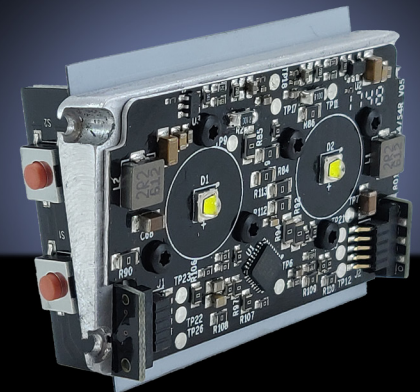



B6r

SUPRABEAM HIGHLIGHTS

- UK** RAM Air Cooling System - Performance cooling system for maximum power output
- FR** RAM Air Cooling System - Système de refroidissement performant pour une puissance maximale
- DE** RAM Air Cooling System - Leistungsstarkes Kühlsystem für maximale Ausgangsleistung
- DK** RAM Air Cooling System - Performance kølesystem for maksimal ydelse
- ES** RAM Air Cooling System - Sistema de refrigeración de alto rendimiento para obtener la máxima potencia en todo momento



KEY FEATURES

UK BATTERY INDICATOR ON HEAD AND POWERPACK
FR INDICATEUR DE BATTERIE SUR LA LAMPE ET SUR LE PACK BATTERIE
DE BATTERIEANZEIGE AM LEUCHTKOPF UND BATTERIE
DK BATTERIINDIKATOR PÅ HOVED OG POWERPACK
ES INDICADOR DE BATERÍA EN EL CABEZAL Y POWERPACK

UK HIGH PERFORMANCE COOLING SYSTEM
FR SYSTÈME DE REFRROIDISSEMENT HAUTE PERFORMANCE
DE HOCHLEISTUNGSKÜHLSYSTEM
DK PERFORMANCE KØLESYSTEM
ES SISTEMA DE REFRIGERACIÓN DE ALTO RENDIMIENTO

UK SEPARATE ON/OFF SWITCH AND TOGGLE SWITCH
FR INTERRUPTEUR MARCHE/ARRÊT ET INTERRUPTEUR À BASCULE SÉPARÉS
DE SEPARATER EIN/AUS-SCHALTER UND KIPPSCHALTER
DK SEPARAT ON/OFF KONTAKT OG LYSSTYRING
ES INTERRUPTOR DE ENCENDIDO/APAGADO Y CONMUTADOR SEPARADOS

UK ROBUST BAJONET PLUG SYSTEM
FR SYSTÈME DE PRISE BAILLONNETTE ROBUSTE
DE ROBUSTES BAJONETT-STECKSYSTEM
DK ROBUST BAJONETSTIK
ES SISTEMA DE ANCLAJE BAJONET

UK EASY AND FAST MOUNTING
FR MONTAGE FACILE ET RAPIDE
DE EINFACHE UND SICHERE MONTAGE
DK NEM OG HURTIG MONTERING
ES MONTAJE FÁCIL Y RÁPIDO

UK QUICK RELEASE MOUNT
FR FIXATION RAPIDE
DE QUICK RELEASE-HALTERUNG
DK QUICK RELEASE MOUNT
ES MONTAJE DE LIBERACIÓN RÁPIDA

B6r | POWER BIKE LIGHT

UK SEPARATE ON/OFF SWITCH AND TOGGLE SWITCH
 FR INTERRUPTEUR MARCHÉ/ARRÊT ET INTERRUPTEUR À BASCULE SÉPARÉS
 DE SEPARATER EIN/AUS-SCHALTER UND KIPPSCHALTER
 DK SEPARAT ON/OFF KONTAKT OG LYSSTYRING
 ES INTERRUPTOR DE ENCENDIDO/APAGADO Y CONMUTADOR SEPARADOS

UK QUICK RELEASE MOUNT
 FR FIXATION RAPIDE
 DE QUICK RELEASE-HALTERUNG
 DK QUICK RELEASE MOUNT
 ES MONTAJE DE LIBERACIÓN RÁPIDA



B6r

POWERPACKS

UK CHOOSE THE BATTERY SIZE THAT SUITS YOUR NEEDS
 FR CHOISISSEZ LA TAILLE DE LA BATTERIE QUI CONVIENT À VOS BESOINS
 DE WÄHLEN SIE DIE BATTERIEGRÖSSE, DIE IHREN BEDÜRFNISSEN ENTSPRICHT
 DK VÆLG BATTERISTØRRELSER DER PASSER TIL DINE BEHOV
 ES ELIJA EL TAMAÑO DE LA BATERÍA QUE SE ADAPTE A SUS NECESIDADES



72Wh

36Wh

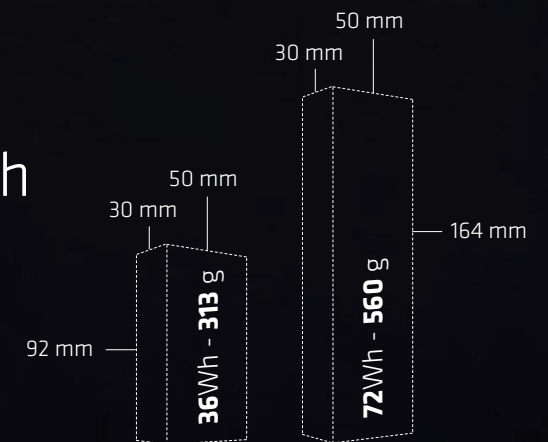

UK SOLID ALUMINIUM HOUSING
 FR SOLIDE BOÎTIER EN ALUMINIUM
 DE SOLIDEN ALUMINIUMGEHÄUSE
 DK SOLIDT ALUMINIUMSHUS
 ES SÓLIDA CARCASA DE ALUMINIO

B6r
36 Wh



SCAN FOR MORE INFO

P/N: 302.1001

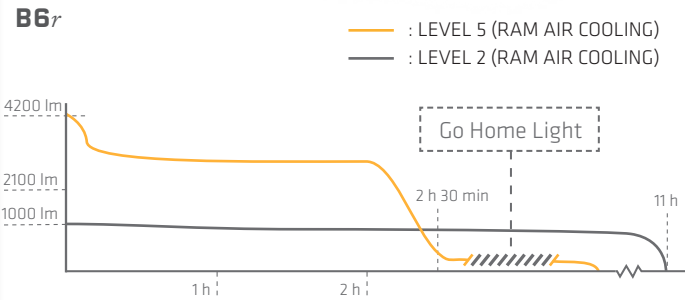

4200 LUMENS



B6r
WATER- AND DUSTPROOF



B6r
72 Wh



P/N: 302.1002

4200 LUMENS



ALKALINE

UK TYPICAL ALKALINE LIGHT CURVE
 FR COURBE DE LUMIÈRE ALCALINE TYPIQUE
 DE TYPISCHE ALCALINE LICHTKURVE
 DK TYPISK ALCALINE LYSKURVE
 ES CURVA DE LUZ ALCALINA COMÚN

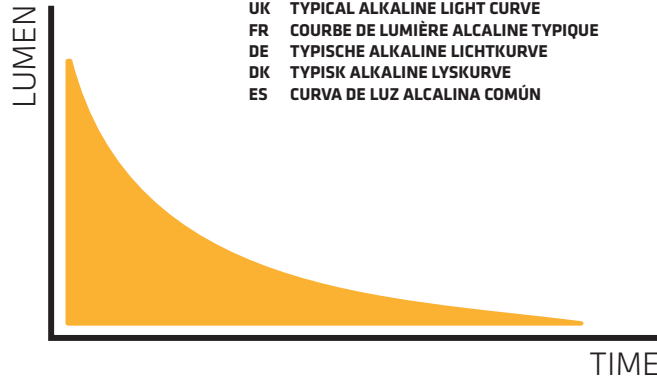

UK At the time marked, the lumen output indicated is still given! +/- 15% Values.
 FR A l'instant marqué, le flux lumineux indiqué est toujours donné! +/- 15% des valeurs
 DE Zum markierten Zeitpunkt wird die angegeben Lumenzahl noch erreicht! +/- 15% der Werte
 DK Ved den markede tid er lysniveauet/lumen indikeret tilgængeligt! +/- 15 % værdier
 ES ¡En el tiempo señalado, se sigue manteniendo la potencia indicada en lúmenes! Valores de +/- 15%

MAX :

UK Maximum lumen output for a short time! <5Min.
 FR Puissance lumineuse maximale pendant une courte période! <5Min.
 DE Maximale Lumenzahl für eine kurze Zeit <5Min.
 DK Max lumen = Lysniveau i kort tid <5Min.
 ES Máxima potencia lumínica en un tiempo breve <5Min.

RECHARGEABLE

UK TYPICAL RECHARGEABLE LIGHT CURVE
 FR COURBE DE LUMIÈRE RECHARGEABLE TYPIQUE
 DE TYPISCHE LICHTKURVE "WIEDERAUFLADBAR"
 DK TYPISK GENOPLADELIG LYSKURVE
 ES CURVA DE LUZ RECARGABLE COMÚN

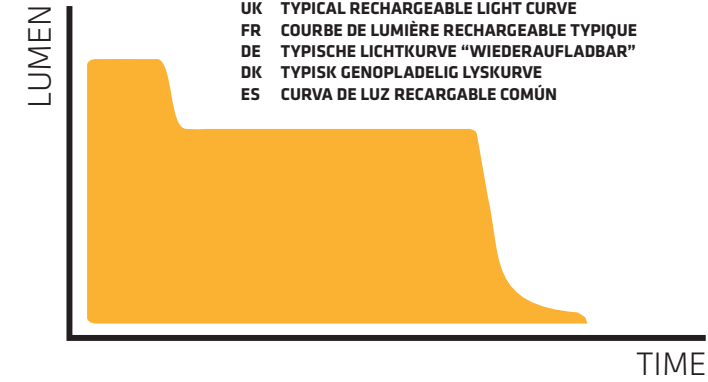

LUMEN/TIME	Q1 <i>mini</i>	Q1/Q1 <i>True color</i>	Q2	Q3 <i>classic</i>	Q3	Q4/Q4 <i>defend</i>	V3 <i>air</i>	S2	Q1r	Q2r	Q3r	Q4xr	Q5xr <i>defend</i>	Q7 <i>xrs</i>	M6r	M6xr	V3 <i>air rechargeable</i>	V3 <i>pro rechargeable</i>	V4 <i>pro rechargeable</i>	S4 <i>rechargeable</i>
2000 LUMEN / MAX														●		●				
1000 LUMEN / >2h														● 5h						
1000 LUMEN / <2h														●						
1000 LUMEN / <1h														●						
1000 LUMEN / MAX											●		●	●		●		●	●	
500 LUMEN / >2h											● 2h			●		● 2,5h				
500 LUMEN / <2h											●			●		●				●
500 LUMEN / <1h											●			●	●	●				●
500 LUMEN / MAX									●		●	●	●	●	●	●		●	●	●
250 LUMEN / >2h											●	● 5h	● 4h	●	●	●		● 5h	● 4,5h	● 2h
250 LUMEN / <2h											●	●	●	●	●	●	●	●	●	●
250 LUMEN / <1h					●	●	●		●	●	●	●	●	●	●	●	●	●	●	●
250 LUMEN / MAX				●	●	●	●	●	●	●	●	●	●	●	●	●	●	●	●	●
100 LUMEN / >2h											● 2,5h	●	●	●	●	●	● 4h	●	●	●
100 LUMEN / <2h				●	●	●	●	●	●	●	●	●	●	●	●	●	●	●	●	●
100 LUMEN / <1h	●	●	●	●	●	●	●	●	●	●	●	●	●	●	●	●	●	●	●	●
100 LUMEN / MAX	●	●	●	●	●	●	●	●	●	●	●	●	●	●	●	●	●	●	●	●



SUPRABEAM HIGHLIGHTS

- UK** Convert your torch/head torch into a superbly effective bulb
- FR** Convertissez votre torche/lampe frontale en une ampoule extrêmement efficace
- DE** Verwandeln Sie Ihre Taschenlampe/Stirnlampe in eine supereffektive Glühbirne
- DK** Konverter din lommelygte/pandelampe til en yderst effektiv pære
- ES** Convierta su linterna / linterna frontal en una eficiente bombilla multiusos



ACCESSORIES



SCAN FOR MORE INFO

PART NO.: 950.070



UK - HELMET MOUNT
FR - SUPPORT DE CASQUE
DE - BEFESTIGUNG SEITLICH FÜR HELMSCHLITZ
DK - SIKKERHEDSHJELM BESLAG
ES - ADAPTADOR PARA CASCOS DE SEGURIDAD

PART NO.: 950.072



UK - FAST RAIL
FR - RAIL RAPIDE
DE - HELMBEFESTIGUNG SEITLICH FÜR RAILSYSTEM
DK - MILITÆR HJEMMESLAG
ES - ADAPTADOR PARA CASCOS FAST RAIL

PART NO.: 950.028



UK - DIFFUSER BULB - Q3/V3
FR - AMPOULE DIFFUSEUR - Q3/V3
DE - LICHT STREUER - Q3/V3
DK - LYSSKÆRM - Q3/V3
ES - ADAPTADOR PARA ACAMPAR - Q3/V3

PART NO.: 950.074



UK - STRAP MOUNT
FR - BANDES UNIVERSELLES
DE - UNIVERSELLE KLETTVERSCHLÜSSE
DK - UNIVERSELLE STROPPER
ES - CINTAS DE VELCRO

PART NO.: 950.076



UK - HELMET CLIP (S-SERIES)
FR - CLIP DE CASQUE (LA SÉRIE S)
DE - HELMCLIP (S-SERIES)
DK - HJELMCLIP (S-SERIEN)
ES - CLIP PARA CASCOS (SERIE S)

PART NO.: 950.082



UK - ADHESIVE HELMET MOUNT (S-SERIES)
FR - ADAPTATEUR DE CASQUE ADHÉSIF (LA SÉRIE S)
DE - KLEBEHALTERUNG MIT SCHLITZ FÜR CLIP (S-SERIES)
DK - SELVKLÆBENDE HJELMADAPTER (S-SERIEN)
ES - ADAPTADOR ADHESIVO PARA CASCOS (SERIE S)

PART NO.: 951.020



UK - LI-PO 16600 1100 mAh BATTERY (Q2r)
FR - LI-PO 16600 1100 mAh BATTERIE (Q2r)
DE - LI-PO 16600 1100 mAh BATTERIE (Q2r)
DK - LI-PO 16600 1100 mAh BATTERI (Q2r)
ES - LI-PO 16600 1100 mAh BATERÍA (Q2r)

PART NO.: 951.023



UK - LI-ION 18650 3000 mAh BATTERY (Q3r)
FR - LI-ION 18650 3000 mAh BATTERIE (Q3r)
DE - LI-ION 18650 3000 mAh BATTERIE (Q3r)
DK - LI-ION 18650 3000 mAh BATTERI (Q3r)
ES - LI-ION 18650 3000 mAh BATERÍA (Q3r)

PART NO.: 951.019



UK - LI-ION 18650 3000 mAh BATTERY (M6r/M6xr)
FR - LI-ION 18650 3000 mAh BATTERIE (M6r/M6xr)
DE - LI-ION 18650 3000 mAh BATTERIE (M6r/M6xr)
DK - LI-ION 18650 3000 mAh BATTERI (M6r/M6xr)
ES - LI-ION 18650 3000 mAh BATERÍA (M6r/M6xr)

PART NO.: 950.086



UK - FOAM PADS V-SERIES
FR - COUSSINETS EN MOUSSE POUR LA SÉRIE V
DE - SCHAUMSTOFF PAD FÜR V-SERIEN
DK - SKUMPUDER V-SERIE
ES - ALMOHADILLAS DE ESPUMA PARA LA SERIE V

PART NO.: 950.083



UK - FOAM PADS S-SERIES
FR - COUSSINETS EN MOUSSE POUR LA SÉRIE S
DE - SCHAUMSTOFF PAD FÜR S-SERIEN
DK - SKUMPUDER S-SERIE
ES - ALMOHADILLAS DE ESPUMA PARA LA SERIE S

PART NO.: 950.094



UK - FOAM PADS M-SERIES
FR - COUSSINETS EN MOUSSE POUR LA SÉRIE M
DE - SCHAUMSTOFF PAD FÜR M-SERIEN
DK - SKUMPUDER M-SERIE
ES - ALMOHADILLAS DE ESPUMA PARA LA SERIE M

PART NO.: 951.021



UK - LI-ION 26650 5000 mAh BATTERY (Q7xrs)
FR - LI-ION 26650 5000 mAh BATTERIE (Q7xrs)
DE - LI-ION 26650 5000 mAh BATTERIE (Q7xrs)
DK - LI-ION 26650 5000 mAh BATTERI (Q7xrs)
ES - LI-ION 26650 5000 mAh BATERÍA (Q7xrs)

PART NO.: 950.014



UK - Q2/Q3/V3 COLOUR FILTERS
FR - Q2/Q3/V3 FILTRES COULEURS
DE - Q2/Q3/V3 FARBFILTER
DK - Q2/Q3/V3 FARVEFILTER
ES - Q2/Q3/V3 FILTROS DE COLOR

PART NO.: 950.012



UK - BIKE MOUNT
FR - FIXATION POUR GUIDON
DE - FAHRRAD HALTERUNG
DK - CYKELMONTERING
ES - ADAPTADOR PARA BICICLETAS

PART NO.: 951.022



UK - LI-PO 1400 mAh USB BATTERY
FR - LI-PO 1400 mAh USB BATTERIE
DE - LI-PO 1400 mAh USB BATTERIE
DK - LI-PO 1400 mAh USB BATTERI
ES - BATERÍA USB LI-PO 1400 mAh (V3air rechargeable)

PART NO.: 951.017



UK - LI-PO 2800 mAh USB BATTERY
FR - LI-PO 2800 mAh USB BATTERIE
DE - LI-PO 2800 mAh USB BATTERIE
DK - LI-PO 2800 mAh USB BATTERI
ES - BATERÍA USB LI-PO 2800 mAh (V3/V4pro rechargeable)

PART NO.: 951.015



UK - LI-PO 1400 mAh USB BATTERY
FR - LI-PO 1400 mAh USB BATTERIE
DE - LI-PO 1400 mAh USB BATTERIE
DK - LI-PO 1400 mAh USB BATTERI
ES - BATERÍA USB LI-PO 1400 mAh (S-Series)

PART NO.: 950.096



UK - ANGLED LIGHT GUIDE (Q1-SERIES)
FR - DÉFLECTEUR DE LUMIÈRE (LA SÉRIE Q1)
DE - LICHTUMLENKER (Q1-SERIES)
DK - VINKLET LYSLEDER (Q1-SERIEN)
ES - DEFLECTOR DE LUZ (SERIE Q1)

PART NO.: 950.095/950.081/950.087



UK - TRAFFIC WAND
FR - CÔNE DIFFUSEUR
DE - VERKEHRSWARNUNG
DK - TRAFIK KEGLE
ES - SEÑAL DE TRÁFICO

PART NO.: 950.009



UK - EXTENSION CABLE - 1.3 M
FR - CÂBLE D'EXTENSION - 1.3 M
DE - VERLÄNGERUNGSKABEL - 1.3 M
DK - FORLÆNGERKABEL 1.3 M
ES - CABLE DE EXTENSION - 1.3 M (V3/V4pro rechargeable)

PART NO.: 950.301



UK - EXTENSION CABLE - 70 CM
FR - CÂBLE D'EXTENSION - 70 CM
DE - VERLÄNGERUNGSKABEL - 70 CM
DK - FORLÆNGERKABEL 70 CM
ES - CABLE DE EXTENSION - 70 CM (B6r)

PART NO.: 950.302



UK - GOPRO MOUNT
FR - SUPPORT GOPRO
DE - GOPRO-HALTERUNG
DK - GOPRO MOUNT
ES - SOPORTE PARA GOPRO (B6r)



Suprabeam is manufactured by
the Steiner Group and distributed
worldwide by:

Steiner A/S
Dyssen 3
DK-8200 Aarhus N, Denmark
Phone: +45 87 525 212

P/N: 006.0036

All technical data and information are subject to change without notice

www.suprabeam.com